

MERITOR® SHOCK ABSORBERS





PRODUCT INFO

10 pages



CAB

7 pages



TRUCK

121 pages



TRAILER

11 pages



BUS

18 pages



REAR SUSPENSION

4 pages



TECHNICAL SPECS

5 pages



CROSS REFERENCE

24 pages



PRODUCT INFO

AFTERMARKET PARTS WARRANTY	1
SYMBOLS	2
SHOCK ABSORBER MOUNT TYPES	3
ALLFIT STANDARD TO PREMIUM INTERCHANGE	4
HEAVY DUTY SHOCK FEATURES	5
A GUIDE TO INSPECTING TRUCK SHOCK ABSORBERS	8
SHOCK ABSORBER HEAT TEST	9
BLEEDING SHOCK ABSORBERS	10

Aftermarket Parts Warranty

We warrant all new parts for one year from date of shipment to the buyer against defective material or workmanship (but not against damage caused by accident, abuse or improper installation, maintenance or repair) when such parts are used on vehicles the specifications of which have been approved by our Engineering Department.

As the exclusive remedy under this warranty, we will, at our option, repair or replace such parts free of charge, or take back the nonconforming parts and refund the monies paid by buyer for such parts, if found on examination by us to be nonconforming and if necessary return charges are prepaid.

If it is necessary to return any parts under this warranty, buyer agrees not to make any deduction on account thereof from remittances on current accounts while claims are in the process of disposition. Any expense incurred without our consent for repairs or replacement will not be allowed.

THIS WARRANTY IS EXPRESSLY IN LIEU OF ALL OTHER WARRANTIES OR CONDITIONS, EXPRESS, IMPLIED OR STATUTORY, INCLUDING ANY IMPLIED WARRANTY OF MERCHANTABILITY OR FITNESS FOR PARTICULAR PURPOSE. IN NO EVENT SHALL SELLER BE LIABLE FOR INCIDENTAL OR CONSEQUENTIAL DAMAGES OF ANY NATURE.

Only genuine Meritor replacement parts are covered by this aftermarket parts warranty.

Disclaimer

Information contained in this publication is in effect at the time the publication was approved for printing and is subject to change without notice or liability. Meritor, reserves the right to revise the information presented or discontinue the production of parts described at any time.

Manufacturers names, part numbers, symbols or other references appearing in this catalogue are used for reference for order of goods only. Images are also for reference only and not to scale.

Trademark

The designated trademarks are registered marks of their respective owners and Meritor and its affiliates are not commercially connected, affiliated, or associated with any of the owners of such marks. The Meritor products presented herein are not endorsed or authorised by any of the trademark owners.

Copyright

All rights reserved. The Meritor or any part or layout of the catalogue cannot be printed or reproduced without written authorisation from Meritor.



Found an error?

If you detect any errors in this catalogue, please let us know. We want to ensure the information we publish is as accurate as possible. We appreciate your help in making this happen.

Please forward your enquiries to:

Email: meritoraftermarketau@meritor.com

Phone: (03) 8353 6050



Catalogue Details

Symbols

SYMBOL	DESCRIPTION
AIR	Air Suspension
PSS	Parabolic Spring Suspension
MLS	Multi Leaf Suspension
TAP	Tapered Leaf Suspension
AEON	AEON Spring





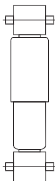
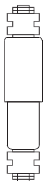
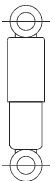
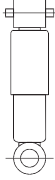
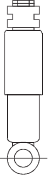
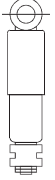
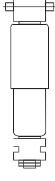
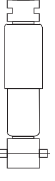
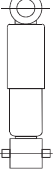

SYMBOL	DESCRIPTION
RBS	Rubber Block Suspension
SS	Spring Suspension
TLS	Trapezium Leaf Suspension
IFS	Independant Front Suspension
TBS	Torsion Bar Suspension

Shock Absorber Mount Types



SYMBOL	DESCRIPTION	SYMBOL	DESCRIPTION	SYMBOL	DESCRIPTION
	O/O Top Eye (with sleeve) / Bottom Eye (with sleeve)		I/I Top Pin/Stud / Bottom Pin/Stud		O/O Top Eye / Bottom Eye
	O/O Top Eye (with sleeve) / Bottom Eye		I/O Top Pin/Stud / Bottom Eye		O/I Top Eye / Bottom Pin/Stud
	O/I Top Eye (with sleeve) / Bottom Pin/Stud		I/O Top Pin/Stud / Bottom Eye (with sleeve)		O/O Top Eye / Bottom Eye (with sleeve)

Catalogue Details

Section Icons

SYMBOL	DESCRIPTION	SYMBOL	DESCRIPTION
	Cab		Truck
	Trailer		Bus
	Rear Suspension		Cross Reference

Page Header Overview

		FRONT				REAR			
		Mount type	Meritor Std	OE	Remarks	Mount type	Meritor Std	OE	Remarks
●	●	●	●	●	●	●	●	●	●
Section Icon	Date Range	Mount type		Front Shocker	Additional product related information		Meritor Part Number	Rear Shocker	



AllFit Standard to AllFit Premium Interchange

All Meritor™ AllFit Standard Shock Absorbers listed below have the alternative to be interchanged with the Meritor™ AllFit Premium Shock Absorber upgrade. Choosing the premium version brings great benefits in durability, performance and comfort.

The interchange must only be used for standard to premium upgrade. The user must not choose the standard shock absorber when the application indicates the use of a premium shock absorber only. Interchange is not reversible.



Heavy Duty Shock Absorber

Engineered for optimum day-in and day-out performance, the Meritor™ AllFit Standard Shock Absorbers has been manufactured with robust components to help ensure longevity and durability on the road. Its Hydraulic Extension Stop technology provides cushion at full extension, delivering greater force absorption than other designs. Meritor™ AllFit Standard Shock Absorbers uses a 10 stage full displacement coil valve for a longer durability and hardened, polished chrome piston rod for superior corrosion resistance and superior performance.



AllFit Premium Adjustable Shock Absorber

The Meritor™ AllFit Premium Adjustable Shock Absorbers features the benefits of the Standard version, plus:

- **3 POSITION ADJUSTABILITY** - Regular, Firm and Extra-Firm, supporting a variety of driving preferences.
- **GAS CELL TECHNOLOGY** - Reduces cavitation of oil under heavy use, maximizing damping efficiency and extending the shock life
- **PREMIUM COMPONENTS** - Delivers better performance under extreme conditions without compromising durability.

Standard	Premium
M83122	M89406
M83123	M89405
M83124	M89407
M83203	M89436
M83207	M89407
M83209	M89414
M83309	M89446
M83312	M89409
M83456	M89447
M85000	M89436
M85001	M89410
M85003	M89411
M85005	M89430
M85007	M89412
M85012	M89413
M85013	M89414
M85024	M89416
M85030	M89440
M85033	M89427
M85036	M89405
M85047	M89435
M85053	M89442
M85300	M89419
M85302	M89420
M85303	M89422
M85308	M89422
M85310	M89423
M85311	M89424
M85305	M89425
M85316	M89426
M85319	M89428
M85320	M89429
M85323	M89436
M85724	M89443
M85918	M89449
M85924	M89457

WHEN THE ROAD IS ROUGH, YOU WANT SHOCKS BUILT TO LAST.

Meritor® Heavy Duty Shock Absorbers

Meritor® heavy-duty shock absorbers are highly engineered to enhance shock life and provide ride comfort. We know how important it is to keep your tires on the road, reduce tire wear and improve braking and handling. That is why we designed our shocks with proven deflective disc technology, to meet the needs of today's fleet customers for road feel and driver fatigue throughout the life of the shock. On average, Meritor® shocks experienced less than 10% reduction in dampening force when tested to 1 million cycles. You can feel confident that your ride will feel smooth and controlled time and time again.

Concerned about your shocks pulling apart? Meritor shocks have an ultimate strength that is up to 20% higher than the competition. Meritor® shocks deliver a comfortable ride for the driver and provide enhanced protection for the cargo, as they are built to withstand harsh road conditions and demanding applications.

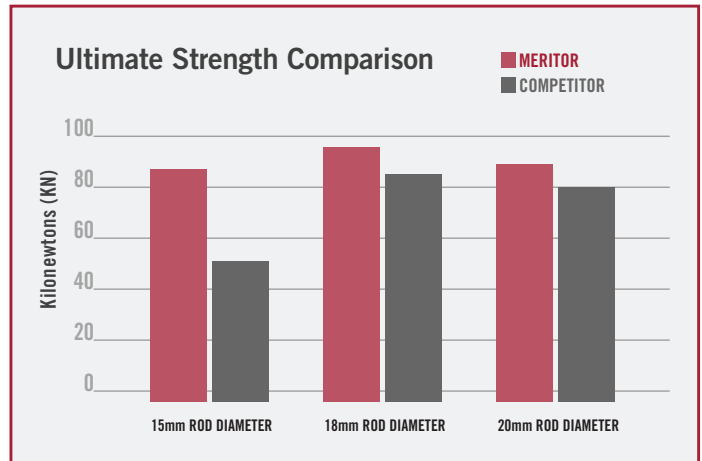

*Shocks were drained of fluid and gases prior to performing test, a 250N/Sec tensile load was applied until failure

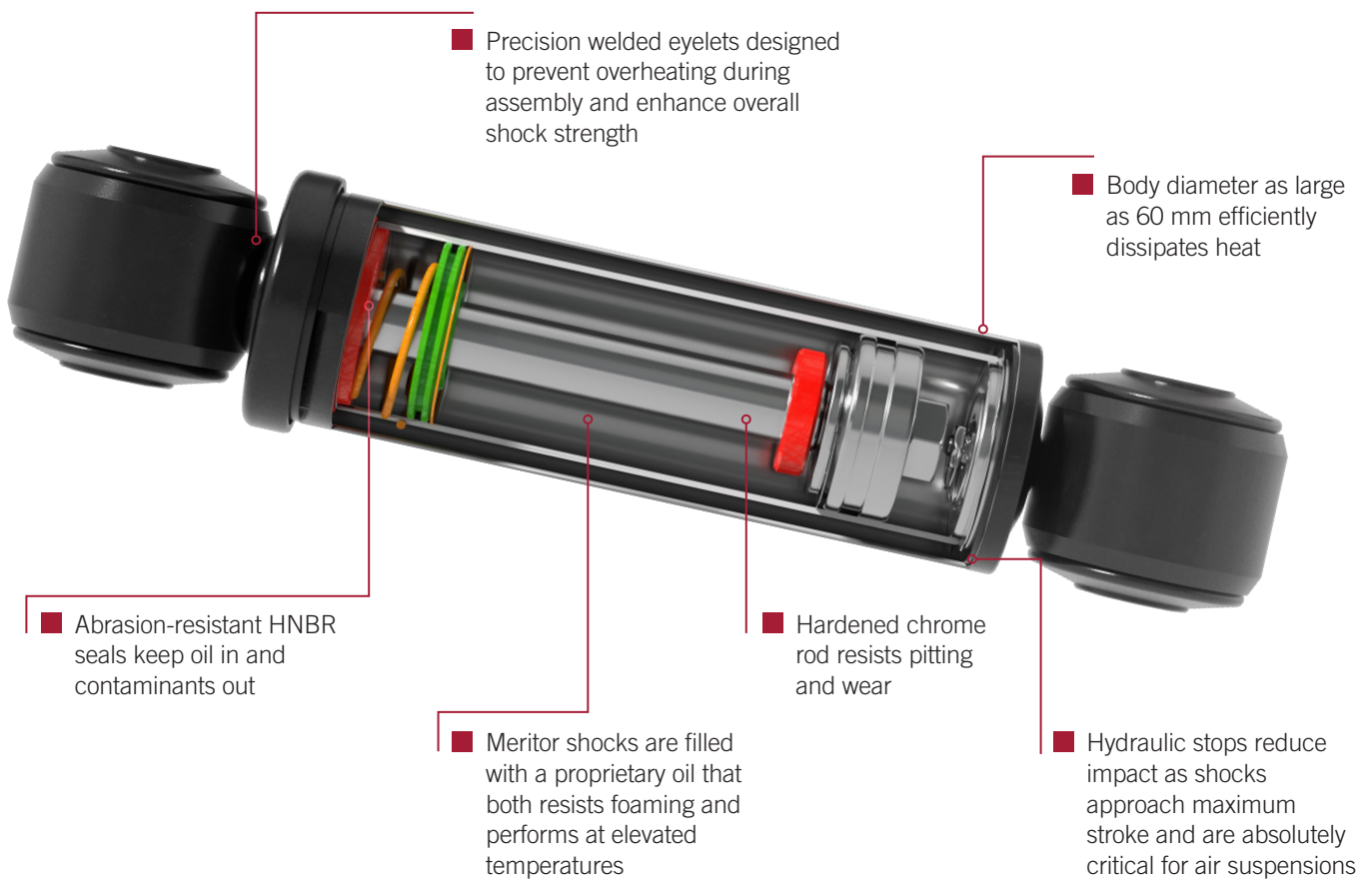

BUILT FOR THE COMPLETE LIFE OF YOUR SHOCK.

Deflective Disc Technology

As suspensions become more advanced, shocks need to keep pace. Select Meritor® shocks feature next-generation deflective disc technology and are designed for excellent braking and handling, as well as longevity and durability on the road. Legacy shocks featuring spring valves are less consistent compared to shocks with deflective discs and degrade over their life, leading to fade. Increases in fade leads to tire wear and degraded ride quality.

**Legacy Shock
With Spring Valve**

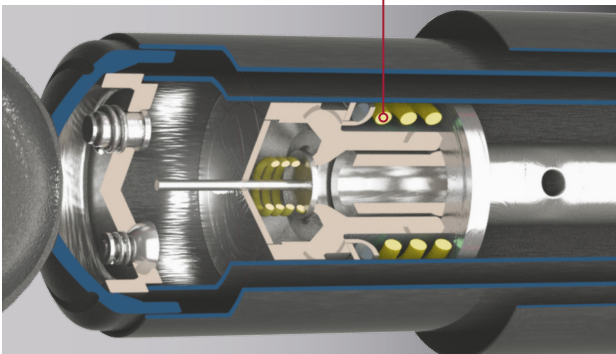

**Meritor® Shock Featuring
Deflective Discs**

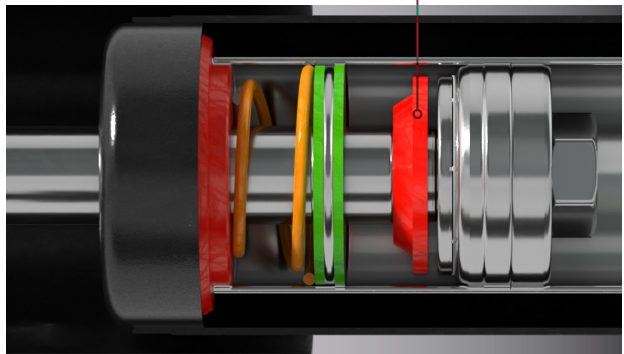

PARTS PERFORMANCE AND SERVICE FOR TOTAL UPTIME.

Consistent Performance

Meritor® shocks feature special application-specific valving to compensate for aeration and maintain consistent forces throughout the shock's life. Shock oil can foam but it does so at a predictable rate. To solve this problem, Meritor's special valving compensates for aeration throughout the life of the shock. Filling a shock with gas can initially solve the aeration problem but over time the gas can leak from the shock increasing fade as the shock ages.

Bushings That Last

Bushings are often overlooked but play an important part in the shock's functionality and life span. Meritor uses high-quality rubber that can handle the forces imposed on the shock ensuring our bushings will last the complete life of the shock.

Hydraulic Stops

Hydraulic stops are important to prevent damage to the shock and suspension components as they approach maximum extension. Meritor's hydraulic stop is designed with application specific valving and an inner limit sleeve to prevent damage to the piston and the valve, further extending the life of our shocks.



Warranties That Are Comforting.

Our Shocks carry a 1-year/unlimited kilometres warranty for your added peace of mind.

Global Presence, Local Presence.

Our experienced Customer Service and DriveForce field team covering the Australasian region will assist with any enquiries and training. For more information, call +61 0 (3) 8353 6050 or visit meritorpartsonline.com.au



A Guide to Inspecting TRUCK Shock Absorbers

Regularly scheduled shock maintenance doesn't cost in the long run - IT SAVES!!

Like most other chassis components, a program of regular scheduled maintenance for shock absorbers will help to avoid overall maintenance costs.

The role of a shock has changed dramatically. Not so many years ago, most suspensions had heavy, multi-leaf springs with limited travel and a great deal of inherent friction. These suspensions quickly self dampened and therefore limited the amount of work the shock needed to perform.

Low friction suspensions such as air and taper leaf have dramatically changed the shock's role. Shocks now play a critical role in dampening suspension oscillation.

Properly functioning shocks can help reduce the wear of more expensive suspension components such as air bags, while assisting in the reduction of tyre wear and vibration through the cab and chassis. They also aid in reducing driver fatigue. Worn shocks simply cannot assist in providing control over today's sophisticated suspension systems.



Leaking vs Misting Shocks

Misting shocks are often misdiagnosed as failures. Misting is the process whereby very small amounts of shock fluid evaporate at high operating temperatures through the upper seal of the shock. When the "mist" reaches the collar outside air, it condenses and forms a film on the outside of the shock body. When mixed with road debris and dust, a grime will often coat the entire body of the shock. Misting is a perfectly normal and necessary function of the shock. The fluid which evaporates through the seal area helps to lubricate and prolong the life of the seal.

Many technicians find it difficult to differentiate between a misting shock and a true leaker which needs to be replaced. A leaker will show clear signs of fluid leaking in streams from the upper seal. These streams can most easily be seen when the shock is fully extended and one inspects as far up the main body of the shock (underneath the dust cover or tube) as possible.



Light Misting -

Light oil film on upper damper body.
No action required - do not remove.

Medium Misting -

Medium oil film on upper damper body.
No action required - do not remove.

Heavy Misting -

Heavy oil/dirt film on upper damper body.
No action required - do not remove.

Leaking -

Oil leak path lines visible on damper - remove and replace.

When should shocks be replaced?

There are many tell tale signs that indicate it may be time to replace shocks.

- **Uneven tyre wear** - balance should be checked first
- **Excess Vibration**
- **Sagging Taper Leaf Springs** - This is not caused by weak shocks
- **Ride Deterioration**
- **Premature Wear** - Cab, electrical and cooling system components
- **Broken or Torn Air Springs** - Shocks will only affect this if they are broken or are missing

Take the "SHOCK HEAT TEST"

Shock absorbers function at temperatures ranging from ambient to 350°F. A shock's role is to dampen the oscillation of the truck's springs. It does this by transforming the energy produced by the spring to heat and dissipating it. As a result the shock should be slightly warm to hot to the touch after normal use.

If ride deterioration is experienced and there is suspicion that a shock has failed internally, which is visually undetectable, perform the following **"SHOCK HEAT TEST"** within a few minutes of operating the equipment:

1. Drive the vehicle at moderate speeds for at least 15 minutes.
2. Within a few minutes of driving the vehicle, touch each shock absorber carefully on its body below the dust cover or tube. After first touching a nearby part of the chassis to establish reference ambient temperature of the metal.
3. All shock absorbers should be warmer than the chassis. Suspect a failure in any shock absorber that is noticeably cooler than its mate on the other end of the axle. Different temperatures from axle to axle do not indicate failures, but cooler temperatures on any one side does warrant removal and examination of the cooler shock absorber.
4. To inspect for an internal failure, remove and shake the suspected shock. Listen for the sound of metal parts rattling inside. Rattling of metal parts can indicate that the shock has an internal failure.

Visual Checks

What potential problems to look out for

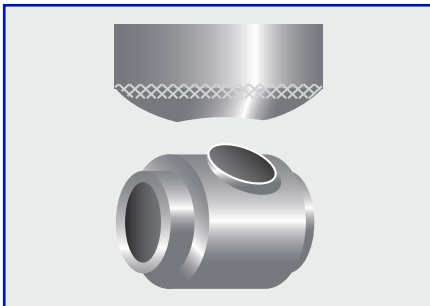

Upper or lower mount broken

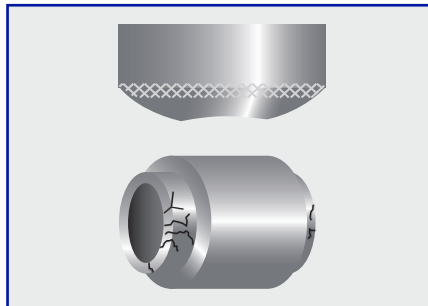

Upper or lower bushing broken

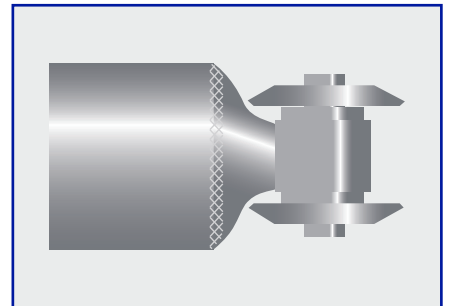

Improper installation:
eg. washers installed backwards

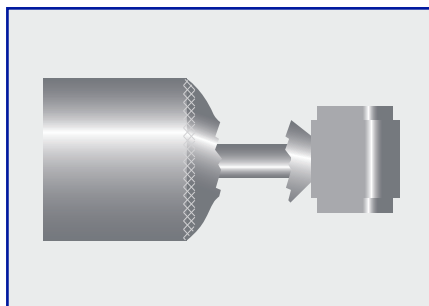

Dust tube broken

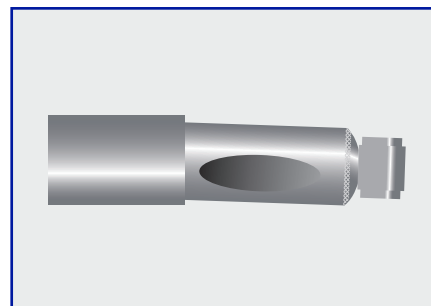

Bent or dented



Bleeding Shock Absorbers

Due to shock absorbers generally being stored in a horizontal position, Meritor recommends that all shock absorbers are bled prior to being installed. Failure to comply may result in a reduced lifespan of the product, damage or cause warranty issues.

How to bleed a shock absorber

Bleeding a shock absorber involves 2 simple processes - the extension of the piston rod (fig. 1), then the collapsing of the piston rod to the assembly (fig. 2). Completing this simple process four to six time will allow the shock absorber to achieve it's full absorption effect immediately after installation.



fig 1: extension of the piston rod

fig 2: collapsing of the piston rod



CAB

ERF NZ	1
FORD	1
FREIGHTLINER	1-2
HINO NZ	2
INTERNATIONAL	2
IVECO	2
KENWORTH	3
MACK	3
MAN	3
MERCEDES BENZ	4
RENAULT (NZ)	4
SCANIA	4-5
STERLING	5
UD/NISSAN	5
VOLVO	5-7
WESTERN STAR	7

		FRONT				REAR			
		Mount	MERITOR	OE	REMARKS	Mount	MERITOR	OE	REMARKS

ERF NZ

EC		O/O	M83023						
----	--	-----	--------	--	--	--	--	--	--

FORD (ALSO REFER STERLING)

Cargo

						O/O	M83033	83DB-5K407-A1C E5HT-5K407-AA F2HT-5K407-AA	
1317, 1417, 1418, 1420, 1421, 3222, 5032, 5036		O/O	1954	52270-1030 52270-1031		O/O		52270-1021 52270-1022	

Trader

N (NZ), 0410		O/O		W20836700A					
--------------	--	-----	--	------------	--	--	--	--	--

Aeromax

inc. HN80						O/O	M83034	66193 F6HZ-5K407-AB F6HZ-5K407-BA 18-45067-00	
-----------	--	--	--	--	--	-----	--------	--	--

Ford Link Cabmate Suspension

FN89						O/O	M83023	1201-0012 1202-0012	
------	--	--	--	--	--	-----	--------	------------------------	--

FREIGHTLINER

Argosy

						O/O	M83044	18-37813-000	
--	--	--	--	--	--	-----	--------	--------------	--

Business Class

						O/O	M83009	18-44321-000	
						O/O	M83006	18-30378 18-29846-000 18-30378-000	
						O/O	M83034	18-45067-000	
Link Cabmate suspension						O/O	M83021	1201-0054 1202-0054	

Century Class & Columbia

Cab Dampers

Sleeper Cab						O/O	M83009	18-44321-000	
						O/O	M83038	18-41762-000 18-41762-002 18-30378-000	
Day Cab						O/O	M83001	18-30378-000 18-32999-000	
							M83006	18-32999-001 18-60295-000 654990	



FLA / FLB / FLC

						O/O	M83009	681-891-0205	
Link Cabmate suspension						O/O	M83023	1201-0012	
							M83021	1201-0054	

MOUNTING DIAGRAMS

O/O	Top Eye (with sleeve) / Bottom Eye (with sleeve)	I/I	Top Pin/Stud / Bottom Pin/Stud	O/O	Top Eye / Bottom Eye
O/O	Top Eye (with sleeve) / Bottom Eye	I/O	Top Pin/Stud / Bottom Eye	O/I	Top Eye / Bottom Pin/Stud
O/I	Top Eye (with sleeve) / Bottom Pin/Stud	I/O	Top Pin/Stud / Bottom Eye (with sleeve)	O/O	Top Eye / Bottom Eye (with sleeve)

1. Please see the Cross Reference section of this catalog for a complete list of OE references.
2. Part number marked in ***Bold Italic*** represent the Premium, adjustable, heavy duty gas shock absorbers.

		FRONT				REAR			
		Mount	MERITOR	OE	REMARKS	Mount	MERITOR	OE	REMARKS

FREIGHTLINER

FL / FLD

Sleeper Cab						O/O	M83009	18-29846-000 18-30378-000	
Day Cab						O/O	M83020	18-31476-000	

Link Cabmate

Link Cab Dampers						O/O	M83023	1201-0012 1202-0012	
							M83021	1201-0054 1202-0054	
							M83025	1201-1043 1201-1044	

HINO NZ (SEE ALSO FORD)

FS						O/O	1954	52270-1030 52270-1031	
SS4533 (NZ)						O/O	1954	52270-1110	

INTERNATIONAL

S & T Line 4700 - All OE STD Cab						O/O	M83023	3261051R1	
All OE Sleeper Cab						O/O		3261147R1	35 mm Bore
Eagle Cab						O/O		26-1481	
Eagle Sleeper Cab						O/O	M83021	2508326C1 1201-0054 1202-0054	

Link Cabmate

IHC83						O/O	M83023	1202-0012	
-------	--	--	--	--	--	-----	--------	-----------	--

IVECO

Turbostar F3470, F4470, F5470						O/O		42087340 42070286	
Eurocargo						O/O	1826	504051670 908273118	

SYMBOLS

AIR	Air Suspension	TAP	Tapered Leaf Suspension	SS	Spring Suspension	TBS	Torsion Bar Suspension
PSS	Parabolic Spring Suspension	AEON	AEON Spring	TLS	Trapezium Leaf Suspension		
MLS	Multi Leaf Suspension	RBS	Rubber Block Suspension	IFS	Independant Front Suspension		

1. Please see the Cross Reference section of this catalog for a complete list of OE references.

2. Part number marked in **Bold Italic** represent the Premium, adjustable, heavy duty gas shock absorbers.



www.meritorpartsonline.com

		FRONT				REAR			
		Mount	MERITOR	OE	REMARKS	Mount	MERITOR	OE	REMARKS

KENWORTH

Link Cabmate

KWB689A						O/O	M83023	1201-0012 1202-0012	
Other Cabmate models						O/O	M83025	1201-1043 1201-1044 1202-0042 1202-0043 1202-0044 1202-1043 1202-1044	
							M83049	1202-1046	
							M83024	1202-1064 1202-1164 1202-1264 1202K064	
							M83002	1202-1065	
							M83021	1202-0054	

M & W Air Ride

M & W Air Ride						O/O	1954	B47467	
----------------	--	--	--	--	--	-----	------	--------	--

MACK

R600 & FIR700						O/I	M83019	14QK2111P4	
MHR, Ultraliner & Series II						I/Θ	M83003	14QK376	
Superliner, Superliner 2, Valueliner						O/I	M83019	14QK2111P4	
MHR, CH, CHR, CLR, Fleetliner Titan						Θ/I	M83041	14QK391AM 14QK391AM2	
Magnum		O/I	M83027	5010130534C		I/I		5010460114A	
Midliner G320 (NZ), G340						O/O		500356647	
CH689 (NZ)						Θ/I	M83041	14QK391AM 14QK391AM2	

Mack Link Cabmate Suspension

MCR600						O/O	M83023	1201-0012 1202-0012	
--------	--	--	--	--	--	-----	--------	------------------------	--

Bonnet, Radiator & Gearbox Dampers

Bonnet Damper, Superliner II		O/O		X70QS32					
Radiator & Gearbox Damper		O/O		X70RC316					

MAN



						O/O	8926	81.41722.6036	
--	--	--	--	--	--	-----	------	---------------	--

MOUNTING DIAGRAMS

O/O	Top Eye (with sleeve) / Bottom Eye (with sleeve)	I/I	Top Pin/Stud / Bottom Pin/Stud	O/O	Top Eye / Bottom Eye
O/O	Top Eye (with sleeve) / Bottom Eye	I/O	Top Pin/Stud / Bottom Eye	O/I	Top Eye / Bottom Pin/Stud
O/I	Top Eye (with sleeve) / Bottom Pin/Stud	I/O	Top Pin/Stud / Bottom Eye (with sleeve)	O/O	Top Eye / Bottom Eye (with sleeve)

- Please see the Cross Reference section of this catalog for a complete list of OE references.
- Part number marked in ***Bold Italic*** represent the Premium, adjustable, heavy duty gas shock absorbers.



		FRONT				REAR			
		Mount	MERITOR	OE	REMARKS	Mount	MERITOR	OE	REMARKS

MERCEDES BENZ

Actros

						O/O	1770	000 891 0205 000 891 0305 000 891 0805 000 891 1005 384 891 7005	
								000 891 0405 000 891 1405 000 891 1605 000 891 2005	
								000 891 0705	
								000 891 1805 000 891 2205	
								344 890 7019	

Engine dampers

Bus engine damper 0404		O/O		664 240 70 48					
------------------------	--	-----	--	---------------	--	--	--	--	--

RENAULT (NZ)

G320, G340						O/O	1826	5000356647	
RT310		O/O	M83022						

SCANIA

82

						O/I	1296	337270 348232 520275	Chassis ~ 4235623
						I / I	1912	349007 367242 524118	Chassis 4235624 ~

93 / 94

Integrated model - For correct application please refer to Air Springs Catalogue

110 / 111

L, LB						O/I	1296	348232 520275	
-------	--	--	--	--	--	-----	------	------------------	--

112

						O/I	1296	348232 520275	Chassis ~ 4235623
						I / I	1912	349007 367242 524118	Chassis 4235624 ~

113

						O/I	1296	348232 520275	
						I / I	1912	349007 367242 524118	

SYMBOLS

AIR	Air Suspension	TAP	Tapered Leaf Suspension	SS	Spring Suspension	TBS	Torsion Bar Suspension
PSS	Parabolic Spring Suspension	AEON	AEON Spring	TLS	Trapezium Leaf Suspension		
MLS	Multi Leaf Suspension	RBS	Rubber Block Suspension	IFS	Independant Front Suspension		

1. Please see the Cross Reference section of this catalog for a complete list of OE references.

2. Part number marked in **Bold Italic** represent the Premium, adjustable, heavy duty gas shock absorbers.

		FRONT				REAR			
		Mount	MERITOR	OE	REMARKS	Mount	MERITOR	OE	REMARKS

SCANIA

140

L, LB						O/I	1296	348232 520275	
						I/I	1912	349007 367242 524118	

142

						O/I	1296	348232 520275	Chassis ~ 4235623
						I/I	1912	349007 367242 524118	Chassis 4235624 ~

143 / 144 / 164 / P & R

Integrated model - For correct application please refer to Air Springs Catalogue

STERLING (ALSO REFER FORD)

8500/9500						O/O	M83034	66193	
-----------	--	--	--	--	--	-----	--------	-------	--

UD/NISSAN

CK60BT (NZ) Import			O/O	1770			O/O	M83009	95245-30Z05
MK185							O/O	M83009	95245-30Z05

VOLVO

F

F7

Vertical			O/O	1770	1580390 1587562		O/O	1770	1580390 1587562
					1594088 1594008-5				1594088 1594008-5
Horizontal			O/O	1758	1580387 1580389		O/O	1758	1580387 1580389

F10/F12

Vertical			O/O	1094	1585586 1599450 1622085 1622086		O/O	1094	1585586 1599450 1622085 1622086
					1580387 1580389		O/O	1758	1580387 1580389
Rear Air							O/O	9021	1586068 1622087

F16



Rear Air							O/O	9021	1586068 1622087
----------	--	--	--	--	--	--	-----	------	--------------------

MOUNTING DIAGRAMS

O/O	Top Eye (with sleeve) / Bottom Eye (with sleeve)	I/I	Top Pin/Stud / Bottom Pin/Stud	O/O	Top Eye / Bottom Eye
O/O	Top Eye (with sleeve) / Bottom Eye	I/O	Top Pin/Stud / Bottom Eye	O/I	Top Eye / Bottom Pin/Stud
O/I	Top Eye (with sleeve) / Bottom Pin/Stud	I/O	Top Pin/Stud / Bottom Eye (with sleeve)	O/O	Top Eye / Bottom Eye (with sleeve)

1. Please see the Cross Reference section of this catalog for a complete list of OE references.
2. Part number marked in ***Bold Italic*** represent the Premium, adjustable, heavy duty gas shock absorbers.



		FRONT				REAR			
		Mount	MERITOR	OE	REMARKS	Mount	MERITOR	OE	REMARKS
VOLVO									
F88									
						O/O	1954	1505892 1508429 1588043 1609428	
FH / FM									
Integrated model - For correct application please refer to Air Springs Catalogue									
FL									
FL7									
		O/O	1770	1089008 1594088 1594008-5		I / I	895250	1089009	Chassis ~ 377368
FL10									
		O/O	1770	1089008 1594088 1594008-5		I / I	895250	1089009	Chassis ~ 561897
FL12									
		O/O	1770	1089008 1594088 1594008-5		I / I	895250	1089009	Chassis 904206 ~
G									
G88									
						O/O	1954	1505892 1508429 1609428 353958 62227 6884278	
N									
N7 / N10 / N12									
						O/O	1954	1508429 1588043 1609428 353958 6884278	
NH									
NH12 (6x4)									
Vertical						O/O	M83028	8078546	
Horizontal						O/O	M83029	8078547	

SYMBOLS

AIR	Air Suspension	TAP	Tapered Leaf Suspension	SS	Spring Suspension	TBS	Torsion Bar Suspension
PSS	Parabolic Spring Suspension	AEON	AEON Spring	TLS	Trapezium Leaf Suspension		
MLS	Multi Leaf Suspension	RBS	Rubber Block Suspension	IFS	Independant Front Suspension		

1. Please see the Cross Reference section of this catalog for a complete list of OE references.

2. Part number marked in **Bold Italic** represent the Premium, adjustable, heavy duty gas shock absorbers.



		FRONT				REAR			
		Mount	MERITOR	OE	REMARKS	Mount	MERITOR	OE	REMARKS



VOLVO									
NL									
NL12									
						O/O	1954	1508429 1588043	
WESTERN STAR									
4800, 4900, 6900 Heritage & Constellation - Day Cab						O/O	M83022	66010-3401 66010-3402 66010-3403 66010-3404 725470	
Constellation Sleeper Cab						O/I	M83027	66010-3406	
Link Cabmate Suspension									
WSC400						O/O	M83023	1202-0012	
						O/O	M83016	1202-0032	

MOUNTING DIAGRAMS					
O/O	Top Eye (with sleeve) / Bottom Eye (with sleeve)	I/I	Top Pin/Stud / Bottom Pin/Stud	O/O	Top Eye / Bottom Eye
O/O	Top Eye (with sleeve) / Bottom Eye	I/O	Top Pin/Stud / Bottom Eye	O/I	Top Eye / Bottom Pin/Stud
O/I	Top Eye (with sleeve) / Bottom Pin/Stud	I/O	Top Pin/Stud / Bottom Eye (with sleeve)	O/O	Top Eye / Bottom Eye (with sleeve)

1. Please see the Cross Reference section of this catalog for a complete list of OE references.
2. Part number marked in ***Bold Italic*** represent the Premium, adjustable, heavy duty gas shock absorbers.

TRUCK

ATKINSON	1
AUSTRAL	1
BEDFORD	1
CHEVROLET	1
COMMER (NZ)	1
DAF	2-3
DAIHATSU	3-4
DODGE	4
FORD	5-7
FORD/HINO (NZ)	7
FREIGHTLINER	8-9
HINO	9-16
INTERNATIONAL	17-21
ISUZU	21-33
IVECO	33-38
KENWORTH	39-40
KIA	40
LEYLAND	40
MACK	40-57
MAN	58-70
MAN NZ	70
MAZDA	70
MERCEDES	70-76
MITSUBISHI	76-81
NISSAN	82
OKA (4X4)	82
PETERBUILT	82
SCAMMEL	82
SCANIA	82-91
SEDDON	91
STERLING	91-93
TOYOTA	94-96
UD	97-105
VOLVO	106-120
WESTERN STAR	120-121
WHITE	121

		FRONT				REAR			
		Mount	MERITOR	OE	REMARKS	Mount	MERITOR	OE	REMARKS

ATKINSON (FOR NZ REFER SEDDON ATKINSON)

F4870	80-83		M83215	3252043R1				
	83-	O/O	M83215	3252648R91				
		O/O	M85303 M89422	453576C92				

AUSTRAL

FIREPACK	-98							
	98-				O/O	M85909		Hendrickson WD2 AIR

BEDFORD

E

EFR, EPRA, EPR3, EPR6	70-74	O/O	M85012 M89413					
ELRA, ELR4, ELR6, ELR8	75-79	O/O	M85062 M89408					
EMT, ERT, ERV	70-79							

M

4x4	70-84	O/O	M85062 M89408		O/O	M85062 M89408		
-----	-------	-----	-------------------------	--	-----	-------------------------	--	--

N

NFM (NZ)	78				O/O	M85012 M89413		
----------	----	--	--	--	-----	-------------------------	--	--

S

SBR422	76	I/O	M63320					
--------	----	-----	--------	--	--	--	--	--

T

TK (NZ)								
TM		I/I	4344					

CHEVROLET

C20, C30 & BLAZER (2WD)	73-91							
C60	66-82	O/O	M85030 M89440		O/O	M85030 M89440		
C2500 (Ambulance)	92-	I/Θ			Θ/O			



COMMER (NZ)

RG13	74-	I/I	4428					
------	-----	-----	------	--	--	--	--	--

MOUNTING DIAGRAMS

O/O	Top Eye (with sleeve) / Bottom Eye (with sleeve)	I/I	Top Pin/Stud / Bottom Pin/Stud	O/O	Top Eye / Bottom Eye
O/O	Top Eye (with sleeve) / Bottom Eye	I/O	Top Pin/Stud / Bottom Eye	O/I	Top Eye / Bottom Pin/Stud
O/I	Top Eye (with sleeve) / Bottom Pin/Stud	I/O	Top Pin/Stud / Bottom Eye (with sleeve)	O/O	Top Eye / Bottom Eye (with sleeve)

1. Please see the Cross Reference section of this catalog for a complete list of OE references.
2. Part number marked in **Bold Italic** represent the Premium, adjustable, heavy duty gas shock absorbers.

		FRONT				REAR			
		Mount	MERITOR	OE	REMARKS	Mount	MERITOR	OE	REMARKS

DAF									
400 Ambulance V8 (NZ)	91-	O/O	M63178						
2300, 2500, 2700, 2800 3200, 3300, 3600	-96	I/O	4191	652722		I/I	2555	655776 1283735	
45 & 55 (4x2)									
45LF (4x2) (FA), 55LF (4x2) (FA)		I/I	4344	LAK7099 WAK3806 ACHF113 ACHF115		I/I	2555	1283735 1401069 AMPC157 LAK7101	PSS
						O/O	40021	1283732	DAF 2 Bag AIR
65									
65CF		I/O	4308	1205672 1283723 1283852		I/I	2555	1283735 AMPC157 LAK7101	PSS
						O/O	40021	1283732	DAF 2 Bag AIR
75 (4x2) (6x2) (6x4) (8x4)									
75CF		I/O	4308	1205672 1283723 1283852		I/I	2555	1283735 AMPC157 LAK7101	4x2 (FA, FT) PSS
					O/O	40021	1283732	4x2 (FA, FT) DAF 4 Bag AIR	
						40085	1443695 1606742		
		O/O	40021	1283732	6x2 (FAS) DAF 8 Bag AIR				
		I/I	4018	1427903		I/I	M85900	665903 665944 70701 K374-41 90-2477SP1	6x4 (FAT,FTT), 8x4 (FAD) Airglide 200 AIR 9" ride height
					O/I		K374-43		
					I/I	M85902	665906 665945	6x4 (FAT,FTT), 8x4 (FAD) Airglide 200 AIR	
					I/I	M85902	K374-38	10.5" ride height	
	O/I		K374-44						



SYMBOLS

AIR	Air Suspension	TAP	Tapered Leaf Suspension	SS	Spring Suspension	TBS	Torsion Bar Suspension
PSS	Parabolic Spring Suspension	AEON	AEON Spring	TLS	Trapezium Leaf Suspension		
MLS	Multi Leaf Suspension	RBS	Rubber Block Suspension	IFS	Independant Front Suspension		

1. Please see the Cross Reference section of this catalog for a complete list of OE references.

2. Part number marked in **Bold Italic** represent the Premium, adjustable, heavy duty gas shock absorbers.



		FRONT				REAR			
		Mount	MERITOR	OE	REMARKS	Mount	MERITOR	OE	REMARKS

DAF

85 (4x2) (6x2) (8x4)									
85CF		I/O	4308	1205672 1283723 1283852 1375974		O/O	40085	1443695 16606742	4x2 (FA, FT) DAF 4 Bag AIR
						I/I	M85900	665903 665944 70701 K374-41 90-2477SP1	6x4 (FAT, FTT), 8x4 (FAD) Airglide 200 AIR 9" ride height
						O/I		K374-43	
		I/I	M85902	665906 665945		Airglide 200 AIR			
		I/I	M85902	K374-38		10.5" ride height			
		O/I		K374-44					

95 (6x4)									
95XF		I/O	4308	1205672		I/I	M85900	665903	6x4 (FAT, FTT), 8x4 (FAD) Airglide 200 AIR 9" ride height
								K374-43	
						I/I	M85902	665906	6x4 (FAT, FTT), 8x4 (FAD) Airglide 200 AIR
							M85902	K374-38	10.5" ride height
							K374-44		

DAIHATSU



DV									
DV20, DV22, DV24, DV32	64-70	O/O	M63178	48510-87301		I/O	56155		
DV21, DV23, DV26 (M & MIXER)	70-8/87	O/O	M63178	48510-87301					
DV21, DV23, DV26, DV28 (L)	70-8/87	O/O	M63178	48510-87301		I/I	56105	48530-87302	
DV21, DV23, DV26, DV28 (T&D) (high Floor & dump)	70-8/87	O/O	M63178	48510-87301					
DV90	82	I/O	M63320	48510-87307A		O/O	M63178	48530-87307-D	

SV									
SV21, SV23, SV26 (T, E & W)	70-8/87	O/O	M63178	48510-87301					

MOUNTING DIAGRAMS

O/O	Top Eye (with sleeve) / Bottom Eye (with sleeve)	I/I	Top Pin/Stud / Bottom Pin/Stud	O/O	Top Eye / Bottom Eye
O/O	Top Eye (with sleeve) / Bottom Eye	I/O	Top Pin/Stud / Bottom Eye	O/I	Top Eye / Bottom Pin/Stud
O/I	Top Eye (with sleeve) / Bottom Pin/Stud	I/O	Top Pin/Stud / Bottom Eye (with sleeve)	O/O	Top Eye / Bottom Eye (with sleeve)

1. Please see the Cross Reference section of this catalog for a complete list of OE references.
2. Part number marked in ***Bold Italic*** represent the Premium, adjustable, heavy duty gas shock absorbers.

		FRONT				REAR			
		Mount	MERITOR	OE	REMARKS	Mount	MERITOR	OE	REMARKS

DAIHATSU

V

V10D	78-93	I/O		48510-87305 48510-87306 48510-87307 48510-87308		O/O	M63178	48530-87310	
V10, V11, V13, V15, V16, V17, V18, V19, V20, V22, V23, V24, V25, V26, V30, V32, V33, V34, V35, V36, V40, V42, V47, V48, V54, V56	77-9/84	I/O		48510-87305 48510-87306 48510-87307 48510-87308		O/O	M63178	48530-87310	
V57, V78, V98 (single tyre)	9/84-	I/O		48510-87307 48510-87308		O/O	M63178	48530-87310	
V57, V98 (low deck & dump)	9/84-	I/O		48510-87307 48510-87308		O/O	M63299	48530-87312	
V58		I/O	M63320	48510-87309		O/O	M63299	48530-87312	
V75 (high Floor & STD dump)	9/84-	I/O		48510-87307 48510-87308		O/O	M63299	48530-87315	
V76 (NZ only)	85-	I/O	M63320						
V78, V98 (dual tyre) exc. low deck	9/84-	I/O		48510-87307 48510-87308		O/O	M63178	48530-87319	
V76, V79, V99 (high Floor) exc. low deck	9/84-	I/O		48510-87307 48510-87308					
V107 (single tyre)	95-	I/O	M63320			O/O	M63178		
V116, V118, V119	93-	I/O				O/O	M63299	48530-87315	
V119 (NZ only)	89-	I/O	63432						

DODGE



D5N (600-700)	72-								
D3F		I/I	M83456 M89447						
RG15 (NZ)	79	I/I	4428						

SYMBOLS

AIR	Air Suspension	TAP	Tapered Leaf Suspension	SS	Spring Suspension	TBS	Torsion Bar Suspension
PSS	Parabolic Spring Suspension	AEON	AEON Spring	TLS	Trapezium Leaf Suspension		
MLS	Multi Leaf Suspension	RBS	Rubber Block Suspension	IFS	Independant Front Suspension		

1. Please see the Cross Reference section of this catalog for a complete list of OE references.

2. Part number marked in **Bold Italic** represent the Premium, adjustable, heavy duty gas shock absorbers.

		FRONT				REAR			
		Mount	MERITOR	OE	REMARKS	Mount	MERITOR	OE	REMARKS

FORD



Cargo									
0812, 0813, 0912, 0913	-84	O/I		81MC-2115-2LB 82DB-18045-BD 83DB-18045-GA EAB819	MLS			81DB-18080-CD EAB805	
		I/I	76034	8126-4376-4MB 83DB-18045-SA EAB1035	2 leaf PSS				
1312, 1313, 1514, 1515, 1617, 1621	-84	O/I		81MC-2115-2LB 82DB-18045-BD 83DB-18045-GA EAB819	MLS			81DB-18080-CD EAB805	
1312, 1313, 1418, 1514, 1515, 1518, 1617, 1621	-84	I/I	76034	8126-4376-4MB 83DB-18045-SA EAB796	2 leaf PSS			81DB-18080-CD EAB805	
1524 (NZ)	94-	O/O	M85303 M89422						
2417, 2419, 2421	82-			EAB319	MLS			81DB-18080-CD EAB805	
		I/I	76034	81MC-2090-3LB EAB796	2 leaf PSS				
2418 (NZ)		I/I	76034			I/I	76034	70DB-18080-BA	

D									
D200, D300, D400	65-68	O/O	M83312 M89409						
D200, D300, D400	68-71	I/I	M83318						
D500, D600, D700, D800	65-68	O/O	M83312 M89409						
D500, D600, D700 D750, D800, D900	68-71	I/I	M83318						
D1210, D1211, D1311, D1314	71-80	I/I	4428						

MOUNTING DIAGRAMS

O/O	Top Eye (with sleeve) / Bottom Eye (with sleeve)	I/I	Top Pin/Stud / Bottom Pin/Stud	O/O	Top Eye / Bottom Eye
O/O	Top Eye (with sleeve) / Bottom Eye	I/O	Top Pin/Stud / Bottom Eye	O/I	Top Eye / Bottom Pin/Stud
O/I	Top Eye (with sleeve) / Bottom Pin/Stud	I/O	Top Pin/Stud / Bottom Eye (with sleeve)	O/O	Top Eye / Bottom Eye (with sleeve)

1. Please see the Cross Reference section of this catalog for a complete list of OE references.
2. Part number marked in **Bold Italic** represent the Premium, adjustable, heavy duty gas shock absorbers.

		FRONT				REAR			
		Mount	MERITOR	OE	REMARKS	Mount	MERITOR	OE	REMARKS

FORD



Louisville / Aeromax

AT9513, FT9513, LT9513	O/O	M83314	79HA-18045-BA	MLS	O/O	M85724 M89443	16-13957-000 16-13957-003 16-15817-000	Airliner FASII AIR
					O/O	M83122 M89406	47902-008 47902-013	Hendrickson HA AIR
					O/O	M85013	47902-024 57905-001	Hendrickson HAS AIR
					O/I	M83112	57241-3 57241-003	Hendrickson HN RBS
					O/O	M85030 M89440	47902-023	Hendrickson WD AIR
						M85909	S-20886	
					O/O	M85909	S-20886	Hendrickson WD2 AIR
O/O	M85909	90045132	Neway AD246 AIR					
HN80, LT8501	O/O	M85054 M89438	F6HT-18045-CC	PSS	O/O	M85724 M89443	16-13957-000 16-13957-003 16-15817-000	Airliner FASII AIR
					O/O	M83122 M89406	47902-008 47902-013	Hendrickson HA AIR
					O/O	M85013	47902-024 57905-001	Hendrickson HAS AIR
					O/I	M83112	57241-3 57241-003	Hendrickson HN RBS
					O/O	M85030 M89440	47902-023	Hendrickson WD AIR
						M85909	S-20886	
					O/O	M85909	S-20886	Hendrickson WD2 AIR
O/O	M85909	90045132	Neway AD246 AIR					
96-97	O/O	M83200	F6HT-18045-JC	All with 54" MLS and with 8500lb or 9000lb Axle				

SYMBOLS

AIR	Air Suspension	TAP	Tapered Leaf Suspension	SS	Spring Suspension	TBS	Torsion Bar Suspension
PSS	Parabolic Spring Suspension	AEON	AEON Spring	TLS	Trapezium Leaf Suspension		
MLS	Multi Leaf Suspension	RBS	Rubber Block Suspension	IFS	Independant Front Suspension		

1. Please see the Cross Reference section of this catalog for a complete list of OE references.
2. Part number marked in **Bold Italic** represent the Premium, adjustable, heavy duty gas shock absorbers.

		FRONT				REAR			
		Mount	MERITOR	OE	REMARKS	Mount	MERITOR	OE	REMARKS

FORD

Louisville / Aeromax

LN700, LN7000	75-12/84	O/O	M83312 M89409	79HA-18045-CA					
LN8000	75-12/84	O/O	M83309 M89446	79HA-18045-AA 79HA-18045-DA					
LNT8000, LTS8000	75-	O/O	M83314	79HA-18045-BA					
LN9000, LNT9000	75-	O/O	M83309 M89446	79HA-18045-AA 79HA-18045-DA					
LS9000, LTA9000, LTL9000, LTS9000		O/O	M83314	79HA-18045-BA	MLS				
			M85006	F1HT-18045-HB	PSS				
			M83312 M89409	F1HT-18045-CA	PSS				
			M83314	79HA-18045-BA	Fleetsaver				

Trader

3000, 3500, 4100	81-	I/O	M63211	W023-34-700 W023-34-710 W023-99-341		O/O	M63299	W023-28-700	
		I/O		W855-34-710 8AW3-34-700					
0409, 0410 (NZ)	87-	I/O	M63211	W023-99-341		O/O	M63299	W023-99-281	
0509, 0510 (NZ), 0711 (NZ)	95	I/O	M63211	W023-99-341		O/O	M63299	W023-99-281	
0510, 0610 (TRITON)	85-	I/O	M63211	W023-99-341					
0713 (NZ)		I/O							
0811	7/90-	I/O	M63211	W023-99-341		O/O	M63299	W023-99-281	
0811, 0812	95	I/O		8AW3-34-700		O/O	M63299	W023-99-281	



FORD / HINO - (NZ ONLY)

FD1017		I/O	M63211						
N0712, N0915, N1015, N1016, N1017, N1117	75-	I/O	M63211						
N1317, N1319, N1417, N1418, N1420, N1421, N1422, N1521, N3222, N5032, N5036	75-	O/O	M85308 M89422						

MOUNTING DIAGRAMS

O/O	Top Eye (with sleeve) / Bottom Eye (with sleeve)	I/I	Top Pin/Stud / Bottom Pin/Stud	O/O	Top Eye / Bottom Eye
O/O	Top Eye (with sleeve) / Bottom Eye	I/O	Top Pin/Stud / Bottom Eye	O/I	Top Eye / Bottom Pin/Stud
O/I	Top Eye (with sleeve) / Bottom Pin/Stud	I/O	Top Pin/Stud / Bottom Eye (with sleeve)	O/O	Top Eye / Bottom Eye (with sleeve)

1. Please see the Cross Reference section of this catalog for a complete list of OE references.
2. Part number marked in **Bold Italic** represent the Premium, adjustable, heavy duty gas shock absorbers.

		FRONT				REAR			
		Mount	MERITOR	OE	REMARKS	Mount	MERITOR	OE	REMARKS

FREIGHTLINER

Argosy

Configuration	Mount	MERITOR	OE	REMARKS	Mount	MERITOR	OE	REMARKS	
6x4, 8x4	99-	O/O	M85918 M89449	10-12703-000 10-13211-000 10-13634-000		O/O	M85724 M89443	16-13957-000 16-13957-003 16-15817-000	Airliner FASII AIR
						O/O	M85956	16-15450-000 16-15770-000	Airliner Tuftrac AIR
						O/O	M85072	60657-003	Hendrickson PAX Primax AIR
						O/O	M85909	90045132	Neway AD246 AIR
						O/O	M85030 M89440	3501001 90045504	

C112 / CL112 / CL120 / CST120 (inc. Century Class & Columbia)

Configuration	Mount	MERITOR	OE	REMARKS	Mount	MERITOR	OE	REMARKS	
6x4		O/O	M85918 M89449	10-13021-000 10-13063-000 10-13211-000 10-13634-000		O/O	M85724 M89443	16-13957-000 16-13957-003 16-15817-000	Airliner FASII AIR
						O/O	M85956	16-15450-000 16-15770-000	Airliner Tuftrac AIR
						O/O	M85072	60657-003	Hendrickson PAX Primax AIR
						O/O	M85909	90045132	Neway AD246 AIR
						O/O	M85030 M89440	3501001 90045504	

FL80 / 106

Configuration	Mount	MERITOR	OE	REMARKS	Mount	MERITOR	OE	REMARKS	
FL80, FL106		O/O	M85024 M89416	680 323 02 00 680 323 03 00		I/O	M85319 M89428	681 326 04 00 16-13947-000	Airliner AIR
						O/O	M85724 M89443	16-13957-000 16-13957-003 16-15817-000	Airliner FASII AIR
						O/O	M85909	90045132	Neway AD246 AIR
						O/O	M85011	681 326 02 00	

FL112 / FLC112

Configuration	Mount	MERITOR	OE	REMARKS	Mount	MERITOR	OE	REMARKS	
FL112, FLC112	90-93	I/O	M85009	681 323 09 00 681 323 13 00		I/O	M85319 M89428	681 326 04 00 16-13947-000	Airliner AIR
						O/O	M85724 M89443	16-13957-000 16-13957-003 16-15817-000	Airliner FASII AIR
						O/O	M85909	90045132	Neway AD246 AIR
	93-	O/O	M85901	10-12542-000		I/O	M85319 M89428	681 326 04 00 16-13947-000	Airliner AIR
						O/O	M85724 M89443	16-13957-000 16-13957-003 16-15817-000	Airliner FASII AIR
						O/O	M85909	90045132	Neway AD246 AIR

SYMBOLS



AIR	Air Suspension	TAP	Tapered Leaf Suspension	SS	Spring Suspension	TBS	Torsion Bar Suspension
PSS	Parabolic Spring Suspension	AEON	AEON Spring	TLS	Trapezium Leaf Suspension		
MLS	Multi Leaf Suspension	RBS	Rubber Block Suspension	IFS	Independant Front Suspension		

1. Please see the Cross Reference section of this catalog for a complete list of OE references.

2. Part number marked in **Bold Italic** represent the Premium, adjustable, heavy duty gas shock absorbers.



www.meritorpartsonline.com

		FRONT				REAR			
		Mount	MERITOR	OE	REMARKS	Mount	MERITOR	OE	REMARKS

FREIGHTLINER

FLB (Airliner)

	96-	O/O	M85320 M89429	10-12032-000 10-12032-001 10-12032-002 10-12032-003 10-12032-004		I/O	M85319 M89428	681 326 04 00 16-13947-000	Airliner AIR
						O/O	M85724 M89443	16-13957-000 16-13957-003 16-15817-000	Airliner FASII AIR

FLC120 / FLD120 (Business Class)

	98-	O/O	M85320 M89429	10-12032-001 10-12032-002 10-12032-003 10-12032-004		I/O	M85319 M89428	681 326 04 00 16-13947-000	Airliner AIR
						O/O	M85724 M89443	16-13957-000 16-13957-003 16-15817-000	Airliner FASII AIR

FLN112

		O/O	M85901	10-12542-000					
		O/O	M85024 M89416	680 323 02 00 680 323 03 00		O/O	M85724 M89443	16-13957-000 16-13957-003 16-15817-000	Airliner FASII AIR

HINO

300

614

XZU307R	06-			48511-37230 48510-80120	short lo pro dump	O/O	M85012 M89413	48531-37010	
XZU347R	06-			48511-37230 48510-80120	medium	O/O	M85012 M89413	48531-37010	

616

XZU407R	06-			48511-37260 48511-80095	short dump	O/O	M85012 M89413	48531-37270	
XZU417R	06-			48511-37260 48511-80095	auto medium	O/O	M85012 M89413	48531-37270	

716

XZU417R	06-			48511-37260 48511-80095	dump, medium	O/O	M85012 M89413	48531-37270	
---------	-----	--	--	----------------------------	--------------	-----	-------------------------	-------------	--

816

XZU417R	06-			48511-37260 48511-80095	auto dump medium	O/O		48531-37280	
XZU427R	06-			48511-37260 48511-80095	crew cab long	O/O		48531-37280	



916

XZU427R	06-			48511-37260 48511-80095	long	O/O		48531-37280	
XZU437R	06-			48511-37260 48511-80095	extra long	O/O		48531-37280	

MOUNTING DIAGRAMS

O/O	Top Eye (with sleeve) / Bottom Eye (with sleeve)	I/I	Top Pin/Stud / Bottom Pin/Stud	O/O	Top Eye / Bottom Eye
O/O	Top Eye (with sleeve) / Bottom Eye	I/O	Top Pin/Stud / Bottom Eye	O/I	Top Eye / Bottom Pin/Stud
O/I	Top Eye (with sleeve) / Bottom Pin/Stud	I/O	Top Pin/Stud / Bottom Eye (with sleeve)	O/O	Top Eye / Bottom Eye (with sleeve)

1. Please see the Cross Reference section of this catalog for a complete list of OE references.
2. Part number marked in **Bold Italic** represent the Premium, adjustable, heavy duty gas shock absorbers.

		FRONT				REAR			
		Mount	MERITOR	OE	REMARKS	Mount	MERITOR	OE	REMARKS

HINO

500

1024, 1027, 1227, 1727 (inc. 6 & 9), 2427, 2627

	08-					O/O	M83144	60670-7 60670-007	Hendrickson HAS AIR
							M85013	60670-005L 48530-3000	

700

4150 Six Rod

FS1E		O/O	M83104	48500-3831					
------	--	-----	--------	------------	--	--	--	--	--

4562/4568

FS1E/SS1E		O/O	M83104	48500-3831		O/O	M83144	60670-7 60670-007	Hendrickson HAS AIR
							M85013	60670-005L 48530-3000	

Dutro Mono

XZU302M						O/O	M85012 M89413	48531-80671 48531-80676	4.5 tonne (mono)
---------	--	--	--	--	--	-----	-------------------------	----------------------------	---------------------

Dutro flat low

XZU307M						O/O	M85012 M89413	48531-80676	4.5 tonne (mono)
---------	--	--	--	--	--	-----	-------------------------	-------------	---------------------

Dutro 2

XZU302M				48511-37140 48511-80078 48511-80080		O/O	M85012 M89413	48531-80671 48531-80676	4.5 tonne (mono)
---------	--	--	--	---	--	-----	-------------------------	----------------------------	---------------------

XZU342M				48511-37140 48511-80078 48511-80080		O/O	M85012 M89413	48531-37010 48531-80673	4.5 tonne (mono)
---------	--	--	--	---	--	-----	-------------------------	----------------------------	---------------------

Dutro 3

XZU402M				48511-37121 48511-80071		O/O	M85012 M89413	48531-37080 48531-37270 48531-80685	4.5 & 5.5 tonne (short)
---------	--	--	--	----------------------------	--	-----	-------------------------	---	----------------------------

XZU412M				48511-37121 48511-80071		O/O	M85012 M89413	48531-37080 48531-37270 48531-80685	4.5 & 5.5 tonne (medium)
---------	--	--	--	----------------------------	--	-----	-------------------------	---	-----------------------------

Dutro 4

XZU411M				48511-37121 48511-80071		O/O	M85012 M89413	48531-37080 48531-37270 48531-80685	4.5 & 6.5 tonne (auto, medium)
---------	--	--	--	----------------------------	--	-----	-------------------------	---	-----------------------------------

Dutro 5000

XZU404				48511-37160 48511-37161 48511-80095		O/O	M85012 M89413	48531-37080 48531-37270	4.5 tonne (short & short hi grade)
--------	--	--	--	---	--	-----	-------------------------	----------------------------	--



XZU414				48511-37160 48511-37161 48511-80095		O/O	M85012 M89413	48531-37080 48531-37270	4.5 tonne CH. JHFUA13H (medium & medium hi grade)
--------	--	--	--	---	--	-----	-------------------------	----------------------------	--

SYMBOLS

AIR	Air Suspension	TAP	Tapered Leaf Suspension	SS	Spring Suspension	TBS	Torsion Bar Suspension
PSS	Parabolic Spring Suspension	AEON	AEON Spring	TLS	Trapezium Leaf Suspension		
MLS	Multi Leaf Suspension	RBS	Rubber Block Suspension	IFS	Independant Front Suspension		

1. Please see the Cross Reference section of this catalog for a complete list of OE references.



2. Part number marked in **Bold Italic** represent the Premium, adjustable, heavy duty gas shock absorbers.

		FRONT				REAR			
		Mount	MERITOR	OE	REMARKS	Mount	MERITOR	OE	REMARKS

HINO									
Dutro 5500									
XZU404R				48511-37160 48511-37161 48511-80095		O/O	M85012 M89413	48531-37080 48531-37270	5.5 tonne (short, short hi grade & dump)
XZU414				48511-37160 48511-37161 48511-80095		O/O	M85012 M89413	48531-37080 48531-37270	5.5 tonne (medium & medium hi grade)
Dutro 6000									
XZU414				48511-37160 48511-37161 48511-80095		O/O	M85012 M89413	48531-37080 48531-37270	4.5 tonne CH JHFUA11H (medium hi grade)
Dutro 6500									
XZU414				48511-37160 48511-37161 48511-80095		O/O	M85012 M89413	48531-37080 48531-37270	6.5 tonne CH. JHFUA11H (medium & medium hi grade)
Dutro 7000									
XZU414				48511-37160 48511-37161 48511-80095		O/O	M85012 M89413	48531-37080 48531-37270	4.5 tonne CH. JHFUA10H (medium & medium hi grade)
XZU424				48511-37160 48511-37161 48511-80095		O/O	M63450	48531-37090	4.5 tonne CH. JHFYA20H (long & hi grade)
Dutro 7500									
XZU414				48511-37160 48511-37161 48511-80095		O/O	M85012 M89413	48531-37080 48531-37270	7.5 tonne CH. JHFUA10H (medium & medium hi grade & dump)
XZU424				48511-37160 48511-37161 48511-80095		O/O	M63450	48531-37090	7.5 tonne CH. JHFYA20H (long & long hi grade)
Dutro 8500									
XZU424				48511-37160 48511-37161 48511-80095		O/O	M63450	48531-37090	8.5 tonne CH. JHFYA22H (long & long hi grade)

MOUNTING DIAGRAMS					
O/O	Top Eye (with sleeve) / Bottom Eye (with sleeve)	I/I	Top Pin/Stud / Bottom Pin/Stud	O/O	Top Eye / Bottom Eye
O/O	Top Eye (with sleeve) / Bottom Eye	I/O	Top Pin/Stud / Bottom Eye	O/I	Top Eye / Bottom Pin/Stud
O/I	Top Eye (with sleeve) / Bottom Pin/Stud	I/O	Top Pin/Stud / Bottom Eye (with sleeve)	O/O	Top Eye / Bottom Eye (with sleeve)

1. Please see the Cross Reference section of this catalog for a complete list of OE references.
2. Part number marked in **Bold Italic** represent the Premium, adjustable, heavy duty gas shock absorbers.

		FRONT				REAR			
		Mount	MERITOR	OE	REMARKS	Mount	MERITOR	OE	REMARKS

HINO

FB (inc. Ranger 4)

FB4J (Ranger 4)	98-	I/O	M63211	48500-2061		O/O	M63173	48530-1600	
FB5B (NZ)	96-	I/O	M63320	48500-1630		O/O	M83216	34802	

FC (inc. Ranger 5 / Pro5)

FC141KA, FC141KD, FC142KA, FC144KA, FC146KA (FLEETER), FC170A (NZ)	84-	I/O	M63320	48500-1290 48500-1291					
			M63211	48500-1520					
FC195 (NZ)		I/O	M63320						
FC2J Ranger (NZ)	98	I/O	M63211	48500-2760					
FC3W (MERLIN)	90-96	I/O	M63211	48500-1520					
FC4F, FC4J HKZ		I/O	M63211			O/O	M89425		

FD (inc. Ranger 6 / Pro6)

FD16, FD17, FD20, FD2218, FD2218LD (FD5H), FE5H, FF5H, FD2220, FD2220	86-03	O/O	M83216	48500-1801	lo pro				
FD164KLA, FD165B (NZ), FD166LA	86-90	I/O	M63211	48500-1520 48500-1521					
FD171KA	80-84	I/O	M63320	48500-1290 48500-1291					
FD172B (NZ), FD173B (NZ), FD174B (NZ), FD176B (NZ)	87-	I/O	M63211						
FD174KA, FD176KA	80-84	I/O	M63320	48500-1290 48500-1291					
FD178B (NZ)		I/O	M63320	48500-1292					
FD2HK (NZ), FD2HL (NZ), FD2S (NZ)	95-	I/O	M63211						
FD1J (Ranger Pro)	03-					O/O	M85013	60670-5 60670-005	Hendrickson HAS AIR

FE

FE3H (inc. Raven)		O/O	M85303 M89422	48500-1730		O/O	M85030 M89440		
	98-04	O/O	M83141	48500-1940					
	83-	I/O	76102						

SYMBOLS



AIR	Air Suspension	TAP	Tapered Leaf Suspension	SS	Spring Suspension	TBS	Torsion Bar Suspension
PSS	Parabolic Spring Suspension	AEON	AEON Spring	TLS	Trapezium Leaf Suspension		
MLS	Multi Leaf Suspension	RBS	Rubber Block Suspension	IFS	Independant Front Suspension		

1. Please see the Cross Reference section of this catalog for a complete list of OE references.

2. Part number marked in **Bold Italic** represent the Premium, adjustable, heavy duty gas shock absorbers.



www.meritorpartsonline.com

		FRONT				REAR			
		Mount	MERITOR	OE	REMARKS	Mount	MERITOR	OE	REMARKS

HINO

FF (inc. Ranger 8)

FF1418 (NZ)		O/O	M85303 M89422						
FF172KA, LA FF172LD, LF FF173KA, LA FF177KA, LA	80-	O/O	M85303 M89422	48500-1140					
FF192KD, FF192LD, FF193KA, FF193KD, FF193LD, FF197KA, FF197LA	84-	O/O	M85303 M89422	48500-1140					
FF1J (4x2) (Ranger 8)	96-	O/O	M85303 M89422	48500-2240		O/O	M83104	48530-1120	
FF2H (Griffin), FF3H (NZ)	91-96	O/O	M85303 M89422	48500-2240		O/O	M83104	48530-1120	

FG (inc. Ranger 9 / Pro 9)

FG172LD, FLTS762LD, FGL75LA, FG177LA, FG192LD, FG193LD, FG195LA, FG197LA	86-90	O/O	M85303 M89422	48500-1140 48500-1730 48500-2240					
FG195 (NZ)		I/O	M63448	48500-2150					
FG3021 (NZ)						O/O	M83104	48530-1900	
FG1J (Ranger 9)	96-	O/O	M85303 M89422	48500-2240					

FL

FL8J (2427 series 500)	08-	O/O		48500-3680		O/O	M83144 M85013	60670-7 60670-007 60670-5 60670-005	Hendrickson HAS AIR
------------------------	-----	-----	--	------------	--	-----	------------------	--	------------------------

FM (inc. Ranger 14 / Pro 14)



FM1J (6x4) (Ranger 14)	96-02	O/O	M85303 M89422	48500-2292					
FM1J (6x4) (Ranger Pro 14)	03-			48500-3680		O/O	M85013	60670-5 60670-005	Hendrickson HAS AIR
FM3HP (NZ)						O/O	M83104		
FM3M	93-97	O/O	M85303 M89422	48500-2292					
FM8J (6x4) (2627 Series 500)	08-			48500-3680	medium, long auto, XX long	O/O	M83144 M85013	60670-7 60670-007 60670-5 60670-005	Hendrickson HAS AIR

MOUNTING DIAGRAMS

O/O	Top Eye (with sleeve) / Bottom Eye (with sleeve)	I/I	Top Pin/Stud / Bottom Pin/Stud	O/O	Top Eye / Bottom Eye
O/O	Top Eye (with sleeve) / Bottom Eye	I/O	Top Pin/Stud / Bottom Eye	O/I	Top Eye / Bottom Pin/Stud
O/I	Top Eye (with sleeve) / Bottom Pin/Stud	I/O	Top Pin/Stud / Bottom Eye (with sleeve)	O/O	Top Eye / Bottom Eye (with sleeve)

1. Please see the Cross Reference section of this catalog for a complete list of OE references.
2. Part number marked in **Bold Italic** represent the Premium, adjustable, heavy duty gas shock absorbers.



		FRONT				REAR			
		Mount	MERITOR	OE	REMARKS	Mount	MERITOR	OE	REMARKS

HINO

FS (inc. Ranger 50 / Super Dolphin / 700)

FS1E (4562 700 Series) (Prime Mover)		O/O	M83104	48500-3831		O/O	M83144	60670-7 60670-007	Hendrickson HAS AIR
							M85013	60670-5 60670-005	
FS1K (Super Dolphin)	92-96	O/O	M89425	48500-1450					
FS1K (Ranger 50)	01-	O/O	M89425	48500-1450					
FS270K (Super Dolphin)	84-90	O/O	M89425	48500-1450					
FS3FKC		O/O	M85303 M89422	48500-2280					
FS631 (NZ), FS635 (NZ), FS660 (NZ)		O/O	M89425						

FT (inc. Ranger 5Z / Pro 5Z)

FT163LA, FT165LA, (Super Dolphin)	86-90	I/O	M63320	48500-1291					
FT1J (Ranger 5Z)	97-	I/O	M63320	48500-1292		O/O	M83104	48530-1120	
FT1J (Ranger Pro 5Z)	03-	I/O	M63320	48500-3070					
FT3W (Kestrel)	90-96	I/O	M63320	48500-1291					

FW (NZ)

FW1F Twin Steer		O/O	M85304		1st Axle				
		O/O			2nd Axle				
FW2S Twin Steer		O/O	M83312 M89409		1st Axle				
			M85304		2nd Axle				
FW609B Twin Steer		O/O	M85304		1st Axle				
					2nd Axle				

FY

FY1K (NZ)	98-	O/O	M89425						
FY335		O/O	M83312 M89409	48500-1610					

GC

GC17	1990-91	O/O	M83217	48530-2050					
GC20	1992	O/O	M83217	48530-2050					

SYMBOLS



AIR	Air Suspension	TAP	Tapered Leaf Suspension	SS	Spring Suspension	TBS	Torsion Bar Suspension
PSS	Parabolic Spring Suspension	AEON	AEON Spring	TLS	Trapezium Leaf Suspension		
MLS	Multi Leaf Suspension	RBS	Rubber Block Suspension	IFS	Independant Front Suspension		

1. Please see the Cross Reference section of this catalog for a complete list of OE references.

2. Part number marked in **Bold Italic** represent the Premium, adjustable, heavy duty gas shock absorbers.





www.meritorpartsonline.com

		FRONT				REAR			
		Mount	MERITOR	OE	REMARKS	Mount	MERITOR	OE	REMARKS

HINO									
GD (inc. Ranger 7 / Pro 7)									
GD1117 (NZ)		I/O	M63211						
GD164LA, GD166LA	86-90	I/O	M63211	48500-1521					
GD171 (NZ)		I/O	M63320						
GD174KA, GD176KA	80-83	I/O	M63320	48500-1291					
GD1J (Ranger)	98-			48500-2220		O/O	M83104	48530-1120	
GD1J (Ranger Pro 7)	03-			48500-3420		O/O	M85013	60670-5 60670-005	Hendrickson HAS AIR
GD8J (4x2), (1227 series 500)	08-			48500-3420	medium, long, X long	O/O	M83144	60670-7 60670-007	Hendrickson HAS AIR
							M85013	60670-5 60670-005	
GH (inc. Ranger 10 / Pro 10)									
GH1H (Super Eagle 1000), GH1HP (NZ)	89-	O/O	M85308 M89422	48500-1730					
GH1J (Ranger 10)	98-	O/O	M85308 M89422	48500-1730		O/O	M85013	47902-024	Hendrickson HAS AIR
GH1J (Ranger Pro 10)	03-			48500-3680		O/O	M85013	60670-5 60670-005	Hendrickson HAS AIR
GH3H (Super Eagle 900)		O/O	M85308 M89422	48500-1730					
GH8J inc. 6 & 9 series, (1727 Series 500)	08-			48500-3680	long auto, medium, X long, XX long	O/O	M83144	60670-7 60670-007	Hendrickson HAS AIR
							M85013	60670-5 60670-005	
GT (inc. Ranger 8Z / Pro 8Z)									
GT173KA, GT173MA, GT175KA, GT175LF, GT175MA, GT175MF	83-	O/O	M63450	48500-1390					
GT1J (Ranger 8Z)	97-	O/O	M63450	48500-1390					
GT3H (Osprey)	89-	O/O	M63450	48500-1390					
H (NZ)									
HE, HF, HG, HH	63-79	O/O	M85308 M89422	6-031-7708-00 6-031-7708-01 6-031-7708-02 6-031-7708-03					
HV99		I/O		48510-87308					
I									
IJKK	97	O/O	M85308 M89422	48500-1730					

MOUNTING DIAGRAMS					
O/O	Top Eye (with sleeve) / Bottom Eye (with sleeve)	I/I	Top Pin/Stud / Bottom Pin/Stud	O/O	Top Eye / Bottom Eye
O/O	Top Eye (with sleeve) / Bottom Eye	I/O	Top Pin/Stud / Bottom Eye	O/I	Top Eye / Bottom Pin/Stud
O/I	Top Eye (with sleeve) / Bottom Pin/Stud	I/O	Top Pin/Stud / Bottom Eye (with sleeve)	O/O	Top Eye / Bottom Eye (with sleeve)

1. Please see the Cross Reference section of this catalog for a complete list of OE references.
2. Part number marked in **Bold Italic** represent the Premium, adjustable, heavy duty gas shock absorbers.

		FRONT				REAR			
		Mount	MERITOR	OE	REMARKS	Mount	MERITOR	OE	REMARKS

HINO

K

KB300		O/O	M85308 M89422	6-071-4800-80					
KB302, KB303, KB304, KB313, KB314, KB322, KB324, KB342, KB344, KB362, KB364, KB382, KB384, KB394, KB501	70-79	O/O	M85308 M89422	48500-1120 6-031-7708-00 6-031-7708-01 6-031-7708-02 6-031-7708-03 6-031-7708-80 6-031-7708-81					
KF300, KF700, KF701, KF702, KF720	70-75	O/O	M85308 M89422	6-031-7708-00 6-031-7708-01 6-031-7708-02 6-031-7708-03 6-031-7708-80 6-031-7708-81					
KF (exc. KF585)	75-79	O/O	M85308 M89422	6-071-4800-81 48500-1120					
KJ	73-86	I/O	M63320	6-301-4800-10 48500-1090					
KL3, KM3, KL5, KM5	70-84	I/O	M63320	6-301-4800-10 48500-1090					
KQ5 (NZ)	70-84	I/O	M63320						
KR300, KR320, KR360	72-82	I/O	M63211	6-071-4802-63 48500-1160					
KU (NZ)	72-82	I/O	M63320						

L

LA540, LA560	80-81	I/O	M63211	48500-1160					
LB500, LB520, LB560	78-82	I/O	M63211	48500-1160					
		O/O	M85308 M89422	48500-1140		O/I	M83112	57241-3 57241-003	Hendrickson HN RBS
LB510 (NZ)	79-84	O/O	M89425						

SS (inc. 700 4568 Prime Mover)

4533 (NZ)	89-	O/O	M85305 M89425	48500-1450					
SS1E (4568 700) (Prime Mover)		O/O	M83104	48500-3831					
					O/O	M83144	60670-7 60670-007	Hendrickson HAS AIR	
		O/O	M85013	60670-5 60670-005					

Z

ZM302 (NZ), ZM342 (NZ)	82-84	O/O	M85308 M89422						
------------------------	-------	-----	-------------------------	--	--	--	--	--	--

SYMBOLS



AIR	Air Suspension	TAP	Tapered Leaf Suspension	SS	Spring Suspension	TBS	Torsion Bar Suspension
PSS	Parabolic Spring Suspension	AEON	AEON Spring	TLS	Trapezium Leaf Suspension		
MLS	Multi Leaf Suspension	RBS	Rubber Block Suspension	IFS	Independant Front Suspension		

1. Please see the Cross Reference section of this catalog for a complete list of OE references.

2. Part number marked in **Bold Italic** represent the Premium, adjustable, heavy duty gas shock absorbers.





www.meritorpartsonline.com

		FRONT				REAR			
		Mount	MERITOR	OE	REMARKS	Mount	MERITOR	OE	REMARKS

INTERNATIONAL									
4900 Navistar									
	97-	I/O	M85316 M89426	2015556C1					
7600									
		O/O		503417026 90-2893		O/O	M85923	3549099C2	International Ride IROS AIR
9200 / 9400 / 9900 Navistar (American Model)									
9200i, 9400i, 9900i		I/O	M85316 M89426	2015556C1 2032533C1		O/O	M85013	3514952C1 47902-024	Hendrickson HAS AIR
							M83209 M89414	60675-003L	
							M85923	3549099C2	International Ride IROS AIR
9200 / 9900 Eagle (Australian Model)									
9200i, 9900i		O/O	M85924 M89457	3270806R1 3581106C2 3581107C2 3581109C3 3584535C1 3584535C2 3584535C3 503421619 88-1641SP1 90-2841		O/O	M85013	57905-001 60670-005	Hendrickson HAS AIR
							M83144	60670-007 60670-007L 60675-006 60675-006L	
							M85072	60657-3 60657-003	Hendrickson PAX Primax AIR
							M85909	90045132	Neway AD246 AIR
M85030 M89440	3501001 90045504								
ACCO									
1820, 1840 (Twin Steer)	66-	O/O	M83225	204994R91	Chassis ~ 21755				
ACCO A									
1710, 1810i 1830, 1910, 2010A (NZ)	72-	O/O	M83215	3017405R91 3252648R91					
410A, 510A inc. 4x4	75-	O/O	M83312 M89409	3018492R91		O/O	M83312 M89409	3018492R91	
3070A	75-	O/O	M83215	3017405R91 3252648R91					
ACCO B									
B	77	O/O	M83215	3017405R91 3252648R91					
3070, 3072, 3074B	78-	O/O	M83215	3017405R91 3252648R91					
610A, 630A (4x4)	80-	I/I	M83318	472367C91					

MOUNTING DIAGRAMS					
O/O	Top Eye (with sleeve) / Bottom Eye (with sleeve)	I/I	Top Pin/Stud / Bottom Pin/Stud	O/O	Top Eye / Bottom Eye
O/O	Top Eye (with sleeve) / Bottom Eye	I/O	Top Pin/Stud / Bottom Eye	O/I	Top Eye / Bottom Pin/Stud
O/I	Top Eye (with sleeve) / Bottom Pin/Stud	I/O	Top Pin/Stud / Bottom Eye (with sleeve)	O/O	Top Eye / Bottom Eye (with sleeve)

1. Please see the Cross Reference section of this catalog for a complete list of OE references.
2. Part number marked in **Bold Italic** represent the Premium, adjustable, heavy duty gas shock absorbers.

		FRONT				REAR			
		Mount	MERITOR	OE	REMARKS	Mount	MERITOR	OE	REMARKS

INTERNATIONAL

ACCO C (inc. 4x4)

	80-	O/O	M83215	3017405R91	FA00215 Axle				
		I/I	M83456	472412C91	FA02309 & FA02339 Axle				

ACCO D

1830D		I/I	M83456	472412C91	FA02339 Axle				
1850D (4x4)	86-	O/O	M83215	3017405R91 3252648R91					
1850D ~ 2250D	86-	I/I	M83456	472412C91	FA02339 Axle				
1850D	91-	I/O	M85316 M89426	1664788C2	02ADE Axle	O/O	M83101	1660846C91	International AIR
		I/I	M83456	472412C91	02337 & 02343 Axle				
1950D, 2200D	91-	I/I	M83456	472412C91					
2300D	91-	I/O	M85316 M89426	1664788C2	02ADE Axle	O/O	M83101	1660846C91	International AIR
		I/I	M83456	472412C91	02337 & 02343 Axle			3261400R91	
2350D (4x2, 6x4)	90-	I/O	M85316 M89426	1664788C2		O/O	M83101	3261400R91	International AIR

ACCO E

1830E	91-	I/I	M83456	472412C91	03514 Axle	O/O	M85013	47902-024	Hendrickson HAS AIR
						O/O	M83101	1660846C91	1850 International AIR
1850E	91-	I/O	M85316 M89426	1664788C2	03AAA Axle	O/O	M85013	47902-024	Hendrickson HAS AIR
						O/O	M83101	1660846C91	1850 International AIR
2350E (Twin Steer)	91-	I/I	M83456	472412C91	02343 Axle	O/O	M85013	47902-024	Hendrickson HAS AIR
						O/O	M83101	1660846C91	1850 International AIR
2350E	91-	I/O	M85316 M89426	1664788C2	K2350 Axle	O/O	M85013	47902-024	Hendrickson HAS AIR
						O/O	M83101	1660846C91	1850 International AIR
								3261400R91	2350 International AIR

SYMBOLS



AIR	Air Suspension	TAP	Tapered Leaf Suspension	SS	Spring Suspension	TBS	Torsion Bar Suspension
PSS	Parabolic Spring Suspension	AEON	AEON Spring	TLS	Trapezium Leaf Suspension		
MLS	Multi Leaf Suspension	RBS	Rubber Block Suspension	IFS	Independant Front Suspension		

1. Please see the Cross Reference section of this catalog for a complete list of OE references.

2. Part number marked in **Bold Italic** represent the Premium, adjustable, heavy duty gas shock absorbers.



www.meritorpartsonline.com

		FRONT				REAR			
		Mount	MERITOR	OE	REMARKS	Mount	MERITOR	OE	REMARKS

INTERNATIONAL

ACCO F

215B (NZ)			M83215	727615					
-----------	--	--	--------	--------	--	--	--	--	--

ACCO G

1850G, T1850G, 2350G, F2350G, T2350G (6x2, 6x4)	95-	I/O	M85316 M89426	1664788C2		O/O	M83101	1660846C91	International AIR
						O/O	M85013	47902-024 57905-001 60670-005	Hendrickson HAS AIR
						O/O	M85072	60657-3 60657-003	Hendrickson PAX Primax AIR
						O/I	M83112	57241-003	Hendrickson HN RBS
						O/O	M83207 M89407	47902-011 60670-002	Hendrickson HN AIR
						O/O	M85909	90045132	Neway AD246 AIR
K2350G (8x4) Twin Steer		I/O	M85316 M89426	3269282R1	1st Axle	O/O	M83101	1660846C91	International AIR
						O/O	M85013	47902-024 57905-001 60670-005	Hendrickson HAS AIR
						O/O	M85072	60657-3 60657-003	Hendrickson PAX Primax AIR
			M85316 M89426	1664788C2	2nd Axle	O/I	M83112	57241-003	Hendrickson HN RBS
						O/O	M83207 M89407	47902-011 60670-002	Hendrickson HN AIR
						O/O	M85909	90045132	Neway AD246 AIR

D / DM

D1210, D1310	71-	O/O	M63173	855466R91		O/O	M63173	855466R91	
D1310 (4x4), D1410 (4x4)		O/O		3209996R91		O/O		3209996R91	
DM1210, DM1310		O/O	M63173	855466R91		O/O	M63173	855466R91	



N

N1630 (CMA86)	83-	I/O	M63320	56101-Z5008		I/I	M83318	56101-Z5001	
N1650 (CMA87)	88-	I/O	M63320	56101-Z5008		I/I	M83318	56101-Z5001	
N1650 (CMF87)	89-	I/O	M63320	56101-Z5008		I/I	M83318	56101-Z5001	
N1750 (CPA87)	89	I/O	M63322	56101-Z5014		I/I	M83318	56101-Z5001	

MOUNTING DIAGRAMS

O/O	Top Eye (with sleeve) / Bottom Eye (with sleeve)	I/I	Top Pin/Stud / Bottom Pin/Stud	O/O	Top Eye / Bottom Eye
O/O	Top Eye (with sleeve) / Bottom Eye	I/O	Top Pin/Stud / Bottom Eye	O/I	Top Eye / Bottom Pin/Stud
O/I	Top Eye (with sleeve) / Bottom Pin/Stud	I/O	Top Pin/Stud / Bottom Eye (with sleeve)	O/O	Top Eye / Bottom Eye (with sleeve)

1. Please see the Cross Reference section of this catalog for a complete list of OE references.
2. Part number marked in **Bold Italic** represent the Premium, adjustable, heavy duty gas shock absorbers.

		FRONT				REAR			
		Mount	MERITOR	OE	REMARKS	Mount	MERITOR	OE	REMARKS

INTERNATIONAL

S Line

S2670	79-	O/O	M83215	3252043R1 3252043R2	FA236 Axle Chassis ~ S01438	O/O	M83101	3261400R91	International AIR
		I/I	M83456	472412C91	Chassis ~ J02060	O/O	M85013	47902-024	Hendrickson HAS AIR
	86	O/O	M83215	3252043R1	02AYB & 02236 Axle Chassis S01483 ~	O/O	M83101	3261400R91	International AIR
							M85013	47902-024	Hendrickson HAS AIR
	92	O/O	M83215	3252043R1	RABA & 02236 Axle	O/O	M83101	3261400R91	International AIR
							M85013	47902-024	Hendrickson HAS AIR
S3300	96-	O/O	M83215	3252043R1	RABA Axle	O/O	M83101	3261400R91	International AIR
							M85013	47902-024	Hendrickson HAS AIR
S3600	92-	O/O	M83215	3252043R1	RABA Axle	O/O	M83101	3261400R91	International AIR
							M85013	47902-024	Hendrickson HAS AIR

T Line

T2670	79-86	O/O	M83215	3252648R91	Chassis ~ R01769	O/O	M83101	3261400R91	International AIR
							M85013	47902-024	Hendrickson HAS AIR
	86-	O/O	M83215	3252043R1	05356 Axle Chassis R01769 ~	O/O	M83101	3261400R91	International AIR
							M85013	47902-024	Hendrickson HAS AIR
T2700 (6x4)	82-	O/O	M83215	3252043R1		O/O	M83101	3261400R91	International AIR
							M85013	47902-024	Hendrickson HAS AIR
T2700 (8x4) (Twin Steer)	96-	O/O	M83215	3252043R1	RABA Axle	O/O	M83101	3261400R91	International AIR
							M85013	47902-024	Hendrickson HAS AIR

LoneStar

	09-12					O/O	M85931	3620395C1	All models with 40,000lb Axle
--	-------	--	--	--	--	-----	--------	-----------	-------------------------------

ProStar

	09-14					O/O	M85931	3620395C1	All models with 40,000lb Axle
--	-------	--	--	--	--	-----	--------	-----------	-------------------------------

SYMBOLS



AIR	Air Suspension	TAP	Tapered Leaf Suspension	SS	Spring Suspension	TBS	Torsion Bar Suspension
PSS	Parabolic Spring Suspension	AEON	AEON Spring	TLS	Trapezium Leaf Suspension		
MLS	Multi Leaf Suspension	RBS	Rubber Block Suspension	IFS	Independant Front Suspension		

1. Please see the Cross Reference section of this catalog for a complete list of OE references.

2. Part number marked in **Bold Italic** represent the Premium, adjustable, heavy duty gas shock absorbers.



www.meritorpartsonline.com

		FRONT				REAR			
		Mount	MERITOR	OE	REMARKS	Mount	MERITOR	OE	REMARKS

INTERNATIONAL

Transtar									
F4270, F4370	77-	O/O	M85303 M89422	453576C92		O/O	M83101	3261400R91	International AIR
							M85013	47902-024	Hendrickson HAS AIR
							M85909	90045132	Neway AD246 AIR 10" ride height

ISUZU

CVP

CVPZ (NZ)	89-	I/O	M85311						
-----------	-----	-----	--------	--	--	--	--	--	--

CVR

CVR (NZ)	86-	I/O	M85311						
----------	-----	-----	--------	--	--	--	--	--	--



CXG

CXG16, CXG17, CXG19, CXG21, CXG23 Twin Steer	8/83- 3/86	O/O	M85304	1-51630131-0	1st Axle				
		I/O	76103	1-51630053-0 1-51630053-1 1-51630053-2	2nd Axle				
CXG166TR, CXG190 (NZ) Twin Steer		O/O	M85304	1-51630131-0	1st Axle				
		I/O	76103	1-51630053-0 1-51630053-1 1-51630053-2	2nd Axle				
CXG180 (NZ) Twin Steer		O/O	M85304	1-51630131-0	1st Axle				
		I/O	76103	1-51630053-0 1-51630053-1 1-51630053-2	2nd Axle				

MOUNTING DIAGRAMS

O/O	Top Eye (with sleeve) / Bottom Eye (with sleeve)	I/I	Top Pin/Stud / Bottom Pin/Stud	O/O	Top Eye / Bottom Eye
O/O	Top Eye (with sleeve) / Bottom Eye	I/O	Top Pin/Stud / Bottom Eye	O/I	Top Eye / Bottom Pin/Stud
O/I	Top Eye (with sleeve) / Bottom Pin/Stud	I/O	Top Pin/Stud / Bottom Eye (with sleeve)	O/O	Top Eye / Bottom Eye (with sleeve)

1. Please see the Cross Reference section of this catalog for a complete list of OE references.
2. Part number marked in **Bold Italic** represent the Premium, adjustable, heavy duty gas shock absorbers.

		FRONT				REAR			
		Mount	MERITOR	OE	REMARKS	Mount	MERITOR	OE	REMARKS

ISUZU

CXH

CXH18V (NZ) (8x4) Twin Steer	-88	O/O	M85304	1-51630131-0	1st Axle				
		I/O	76103	1-51630053-0 1-51630053-1 1-51630053-2	2nd Axle				
CXH71V (NZ) Twin Steer	89-	O/O	M85304		1st Axle				
		I/O	76043		2nd Axle smaller diameter wheel)				
CXH169TR (NZ) Twin Steer	-88	O/O	M85304	1-51630131-0	1st Axle				
		I/O	76103	1-51630053-0 1-51630053-1 1-51630053-2	2nd Axle				
CXH190 (NZ) Twin Steer	-88	O/O	M85304	1-51630131-0	1st Axle				
		I/O	76103	1-51630053-0 1-51630053-1 1-51630053-2	2nd Axle				
CXH194 (NZ) Twin Steer	89-	O/O	M85304		1st Axle				
		I/O	76043		2nd Axle smaller diameter wheel)				
CXH360 (NZ) Twin Steer	98-	O/O	M85304		1st Axle				
					2nd Axle				
CXH370 (NZ) Twin Steer	-88	O/O	M85304	1-51630131-0	1st Axle				
		I/O	76103	1-51630053-0 1-51630053-1 1-51630053-2	2nd Axle				
CXH380 (NZ) Twin Steer	98-	O/O	M85304	1-51630429-0	1st Axle				
				1-51630443-0	2nd Axle				
CXH450 (NZ) Twin Steer	99-	O/O	M85304	1-51630429-0	1st Axle				
				1-51630443-0	2nd Axle				

CXM

CXM	7/83-12/85	I/O	76103	1-51630053-0 1-51630053-1 1-51630053-2 1-51630457-0					
	1/86-			1-51600229-3 1-51600231-3					

CXY

CXY385 (6x4) (Giga Max)	01-	I/O		1-51600399-0		O/O	M85013	47902-024 57905-001 60670-005 1-51630746-0	Hendrickson HAS AIR
-------------------------	-----	-----	--	--------------	--	-----	--------	---	------------------------

CXZ

CXZ (NZ)	89-	I/O	M85311						
	04-			1-51630512-0					
CX71 (NZ)	93	O/O	M85304		PSS				

SYMBOLS



AIR	Air Suspension	TAP	Tapered Leaf Suspension	SS	Spring Suspension	TBS	Torsion Bar Suspension
PSS	Parabolic Spring Suspension	AEON	AEON Spring	TLS	Trapezium Leaf Suspension		
MLS	Multi Leaf Suspension	RBS	Rubber Block Suspension	IFS	Independant Front Suspension		

1. Please see the Cross Reference section of this catalog for a complete list of OE references.

2. Part number marked in **Bold Italic** represent the Premium, adjustable, heavy duty gas shock absorbers.



www.meritorpartsonline.com



		FRONT				REAR			
		Mount	MERITOR	OE	REMARKS	Mount	MERITOR	OE	REMARKS

ISUZU									
CYH									
CYH530 (NZ)		O/O	M85304	1-51630805-1					
ECR									
ECR (NZ)	86-					I/I	2555		
EXD									
EXD455 (4x2) SITEC 455 Series II Premium	08-							1-51630844-0	8 Bag AIR
EXR (4x2) (6x2)									
EXR (NZ) 4x2		I/O	76103	1-51630053-0 1-51630053-2 1-51630457-0					
EXZ (NZ) 6x4		I/O	M85311						
EXY									
EXY425 (6x4) (inc. Giga Max custom)				1-51600399-0		O/O	M85013	47902-024 57905-001 60670-005 1-51630746-0	Hendrickson HAS AIR 19mm mounts
					M83147		60675-5 1-51630785-0	Hendrickson HAS AIR 20mm mounts	
FRD									
FRD11, FRD12	87-	I/O	M63320	1-51630219-0		I/I	76041	1-51630148-0	4 Bag AIR
FRR (4x2)									
FRR11, FRR12, FRR13	87-	I/O	M63320	1-51630033-1 1-51630121-1 1-51630217-0 1-51630218-0					
FRR12 (NZ)		I/O	M63211	1-51630219-1		I/I	M83318	1-51630094-0	
FRR500 (FRR33 / 34)									
FRR500 (FRR33) (SITEC 175)	96-00	I/O	M63211	1-51630219-1 1-51630381-0 1-51630712-0	short, medium, long, crew, auto & PTO				
FRR500, FRR500S (FRR33) (SITEC 175, 200)	00-	I/O	M63211	1-51630219-1 1-51630381-0	auto, short, PTO medium, long & crew				
FRR500 (FRR33/34) (SITEC 175, 200)	03-	I/O	M63211	1-51630219-1 1-51630381-0	auto, medium, long & crew				
FRR525 (FRR33 / 34)									
FRR525 (FRR33) (SITEC 200)	03-	I/O	M63211	1-51630219-1 1-51630381-0	medium & long				
FRR525 (FRR34)	05-	I/O	M63211	1-51630381-0					

MOUNTING DIAGRAMS					
O/O	Top Eye (with sleeve) / Bottom Eye (with sleeve)	I/I	Top Pin/Stud / Bottom Pin/Stud	O/O	Top Eye / Bottom Eye
O/O	Top Eye (with sleeve) / Bottom Eye	I/O	Top Pin/Stud / Bottom Eye	O/I	Top Eye / Bottom Pin/Stud
O/I	Top Eye (with sleeve) / Bottom Pin/Stud	I/O	Top Pin/Stud / Bottom Eye (with sleeve)	O/O	Top Eye / Bottom Eye (with sleeve)

1. Please see the Cross Reference section of this catalog for a complete list of OE references.
2. Part number marked in ***Bold Italic*** represent the Premium, adjustable, heavy duty gas shock absorbers.



		FRONT				REAR			
		Mount	MERITOR	OE	REMARKS	Mount	MERITOR	OE	REMARKS

ISUZU

FRR550 (FRR32 / 33 / 34)

FRR550, FRR550S FRR550T (FRR32, 33) (SITEC 175, 230)	96-98	I/O	M63211	1-51630219-1 1-51630381-0 1-51630712-0	auto, medium, long & crew				
FRR550 (FRR33)	99-	I/O	M63211	1-51630219-1 1-51630381-0 1-51630712-0	medium, long & crew				
FRR550 (FRR32, 33) (SITEC 200, 230)	00-	I/O	M63211	1-51630219-1	medium, long, turbo & crew				
FRR550 (FRR32, 33, 34) (SITEC 220, 255)	03-	I/O	M63211	1-51630381-0	long, medium & crew				
FRR550 (FRR34)	05-	I/O	M63211	1-51630381-0					

FSR (4x2)

FSR113 (NZ)		I/O	M63320						
-------------	--	-----	--------	--	--	--	--	--	--

FSR450 (FRS11) (4x4)

FSR450 (FRS11)	72-85	I/O	M63320	1-51630039-2 1-51630218-0		I/I	M83318	1-51630094-0 9-51630338-0	
		I/O	M63211	1-51630168-1 1-51630217-1			76041	1-51630148-0	

FSR500 (FRS12, 32) (4x2)

FSR500 (FRS12)	72-85	I/O	M63320	1-51630039-2 1-51630218-0		I/I	M83318	1-51630094-0 9-51630338-0	
		I/O	M63211	1-51630219-1			76041	1-51630148-0	
	86-91	I/O	M63320	1-51630039-2 1-51630218-0		I/I	76041	1-51630148-0	
			M63211	1-51630219-1					
FSR500 (FRS12, FSR32) inc. crew cab	92-	I/O	M63320	1-51630039-2 1-51630218-0 1-51630391-0	16mm lower mount pin				

FSR550 (FSR32) (4x2)

FSR550 (FSR32) inc. crew cab	92-	I/O	M63320	1-51630039-2 1-51630290-1 1-51630391-0	16mm lower mount pin				
---------------------------------	-----	-----	--------	--	-------------------------	--	--	--	--

FSR600 (FSR12) (4x2)

FSR600 (FSR12)	86-	I/O	M63320	1-51630217-0 1-51630218-0 1-51630219-0		I/I	76041	1-51630148-0	
----------------	-----	-----	--------	--	--	-----	-------	--------------	--

FSR650 (FSR12, 32) (4x2)

FSR650 (FSR12) inc. crew cab	88-91	I/O	M63320	1-51630290-1 1-51630391-0					
FSR650 (FSR12, FSR32) inc. crew cab	91-	I/O	M63320	1-51630290-1 1-51630391-0	16mm lower mount pin				

SYMBOLS



AIR	Air Suspension	TAP	Tapered Leaf Suspension	SS	Spring Suspension	TBS	Torsion Bar Suspension
PSS	Parabolic Spring Suspension	AEON	AEON Spring	TLS	Trapezium Leaf Suspension		
MLS	Multi Leaf Suspension	RBS	Rubber Block Suspension	IFS	Independant Front Suspension		

1. Please see the Cross Reference section of this catalog for a complete list of OE references.

2. Part number marked in **Bold Italic** represent the Premium, adjustable, heavy duty gas shock absorbers.



www.meritorpartsonline.com

		FRONT				REAR			
		Mount	MERITOR	OE	REMARKS	Mount	MERITOR	OE	REMARKS

ISUZU

FSR700 (FSR32, 33) (4x2)

FSR700 (FSR33) inc. crew cab	88-96	I/O	M63320	1-51630290-1 1-51630391-0					
FSR700, FSR700T (FSR32,33) (SITEC 175, 200, 230)	96-00	I/O	M63320	1-51630381-0	long, auto & crew				
FSR700 (FSR32, FSR33) (SITEC 200, 230)	00-	I/O	M63211	1-51630381-0	long & turbo				
FSR700 (FSR32, FSR33) (SITEC 220, 255)	03-	I/O	M63211	1-51630381-0	16mm lower mount pin				

FSR750 (FSR32) (4x2)

FSR750 (FSR32) inc. crew cab	92-95	I/O	M63320	1-51630290-1	16mm lower mount pin				
---------------------------------	-------	-----	--------	--------------	-------------------------	--	--	--	--

FSS (4x4)

FSS500 (FSS12, 33, 34) (4x4)

FSS500 (FSS12, FSS33)	92-03	I/O	M63320	1-51630039-2					
FSS500 (FSS34)	03-	I/O	M63320	1-51630039-2					

FSS (4x4)

FSS550 (FSS33, FSR34) (4x4)

FSS550 (FSS33) (SITEC 175, 200) inc. crew cab	96-03	I/O	M63320	1-51630039-2					
FSS550 (FSS33, FSS34) (SITEC 190, 220) inc. crew cab	03-	I/O	M63320	1-51630039-2					

FSS700 (4x4)

FSS700	93-	I/O				I/O	76103	1-51630171-1	
--------	-----	-----	--	--	--	-----	-------	--------------	--

FTR (4x2)

FTR800 (FTR11, FTR12, FTR32, FTR33) (4x2)

FTR800 (FTR11, FTR12, FTR32)	1/84- 1/86	I/O	76043	1-51630173-1					
FTR800 (FTR11, FTR12)	86-	I/O		1-51630160-0 1-51630180-3	inc. crew cab 22mm mount	I/I	76041	1-51630148-0	
		I/O	76103	1-51630225-1	Stabiliser Bar 25mm mount				

FTS



FTS12 (4x4)	84-88	I/O	M85311			I/I	M83318	1-51630094-0 9-51630338-0	
FTS500 (FTS12) (4x4)	88-	I/O	M85311						
FTS600 (FTS12) (4x4)		I/O	76103	1-51630171-1 1-51630225-1					
FTS700 (FTS12) (4x4)	92-95			1-51630180-3	inc. crew cab	I/O	76103	1-51630171-1	

MOUNTING DIAGRAMS

O/O	Top Eye (with sleeve) / Bottom Eye (with sleeve)	I/I	Top Pin/Stud / Bottom Pin/Stud	O/O	Top Eye / Bottom Eye
O/O	Top Eye (with sleeve) / Bottom Eye	I/O	Top Pin/Stud / Bottom Eye	O/I	Top Eye / Bottom Pin/Stud
O/I	Top Eye (with sleeve) / Bottom Pin/Stud	I/O	Top Pin/Stud / Bottom Eye (with sleeve)	O/O	Top Eye / Bottom Eye (with sleeve)

1. Please see the Cross Reference section of this catalog for a complete list of OE references.
2. Part number marked in ***Bold Italic*** represent the Premium, adjustable, heavy duty gas shock absorbers.



		FRONT				REAR			
		Mount	MERITOR	OE	REMARKS	Mount	MERITOR	OE	REMARKS

ISUZU

FTS

FTS750 (FTS33) (4x4)

FTS750 (FTS33) (SITEC 200) inc. crew cab	96-98	I/O	76103	1-51630171-1 1-51630225-1					
FTS750 (FTS33) (SITEC 200) inc. crew cab	00-	I/O	M63320	1-51630039-2					
FTS750 (FTS33)	03-	I/O	M63320	1-51630039-2					

FVD

FVD950, FVD950HD (FVD23, FVD32, FVD33) (4x2)

FVD950 (FVD23, FVD32, FVD33) (SITEC 200, 230, 270)	00-			1-51600415-0 1-51630579-0	auto, long, long custom, low profile & crew cab	○/○	M85013	47902-024 60670-005 1-51630746-0	Hendrickson HAS AIR
FVD950, FVD950HD (FVD23, 32) (SITEC 255, 275)	03-			1-51600415-0	Series II auto, long	○/○	M85013	47902-024 60670-005 1-51630746-0	Hendrickson HAS AIR

FVL

FVL1400 (FVL23) (SITEC 270)	00-	I/O	76103	1-51630579-0	long, long custom & low profile	○/○	M85013	47902-024 60670-005 1-51630746-0	Hendrickson HAS AIR
--------------------------------	-----	-----	-------	--------------	---------------------------------------	-----	--------	--	-------------------------------

FVM

FVM1400 (FVM13)	88-91	I/O	76103	1-51630171-1 1-51630225-2					
	92-95	I/O	76043	1-51630173-1 1-51630171-1 1-51630225-2					

FVR

FVR11, FVR12, FVR13	84-2/86	I/O	76103	1-51630111-3					
FVR13	3/86- 2/88	I/O		1-51630160-0 1-51630180-3					

FVR900 (FVR13, FVR23, FVR32, FVR33) (4x2)

FVR900 (FVR13)	88-91	I/O	76103	1-51630225-2					
	92-95	I/O	76103	1-51630304-0 1-51630433-1	25mm lower mount pin				
FVR900 (4x2) (FVR33)	99-	I/O	76103	1-51630579-0	long & PTO				

FVR950 (FVR23, FVR32, FVR33) (4x2)

FVR950 (FVR23, FVR32, FVR33) (SITEC 200, 230, 270)	96-98	I/O	76103	1-51630304-0 1-51630433-1	long, low profile & turbo 25mm lower mount pin				
	99-	I/O	76103	1-51630579-0	medium, long & low profile				
	00-	I/O	76103	1-51630579-0	medium, long & low profile MLS				

SYMBOLS



AIR	Air Suspension	TAP	Tapered Leaf Suspension	SS	Spring Suspension	TBS	Torsion Bar Suspension
PSS	Parabolic Spring Suspension	AEON	AEON Spring	TLS	Trapezium Leaf Suspension		
MLS	Multi Leaf Suspension	RBS	Rubber Block Suspension	IFS	Independant Front Suspension		

1. Please see the Cross Reference section of this catalog for a complete list of OE references.

2. Part number marked in **Bold Italic** represent the Premium, adjustable, heavy duty gas shock absorbers.





www.meritorpartsonline.com

		FRONT				REAR			
		Mount	MERITOR	OE	REMARKS	Mount	MERITOR	OE	REMARKS

ISUZU									
FVY									
FVY1400 (6x4)									
FVY1400 (FVY23) (SITEC 270)	99-			1-51600415-0	auto, long & long custom	O/O	M85013	47902-024	Hendrickson HAS AIR
FVY1400 (FVY23) (SITEC 275)	03-			1-51600415-0		O/O	M85013	47902-024	Hendrickson HAS AIR
FVZ									
FVZ1400 (FVZ13, 23) (6x4)									
FVZ1400	88-91	I/O	76103	1-51630225-2					
FVZ 1400 (FVZ13)	92-95	I/O	76103	1-51630304-0	25mm lower mount pin				
GSR									
		I/O	M63322						
GVD (4x2)									
GVD (SITEC 270) Primemover	5/00-			1-51600415-0		O/O	M85013	47902-024 57905-001 60670-005 1-51630746-0	Hendrickson HAS AIR
GVR (4x2)									
GVR (SITEC 275) Primemover	4/98-4/00	I/O	76103	1-51630641-0					
J									
JBR360, JBR420, JBR520, JCR360, JCR420, JCR520, JDR360, JDR420, JDR520	12/75-12/83	I/O	76043	1-51630020-0 1-51630173-1		I/I	2555		
JCS420 (NZ)	83-84	I/O	76043	1-51630020-0 1-51630173-1					
JCS (4x4)	86-	I/O	M85311						
JGS (4x4)	83-84	I/O	M85311						
JSR420 ~ JSR500	76-80	I/O	M63322						
K									
KB, KBD	1/77-10/80	I/O	69992	9-51630674-2		O/O	M63173	5-51630018-2 5-51630019-1 5-51630046-1 5-51630047-1	
	10/80-	I/O	69992	8-94223752-0				8-94223293-1 8-94426944-0	
KS11,20,21,32	70-80	I/O	M63448	9-51630647-1		O/O	M85012 M89413	5-51630062-0 9-51630666-0	
KT25, 26 (exc. A type)	80-84	I/O	M63448	9-51630647-1		O/O	M85012 M89413	5-51630062-0 9-51630666-0	
L									
L175 (NZ), L195 (NZ)	92-	I/O	M63211						

MOUNTING DIAGRAMS					
O/O	Top Eye (with sleeve) / Bottom Eye (with sleeve)	I/I	Top Pin/Stud / Bottom Pin/Stud	O/O	Top Eye / Bottom Eye
O/O	Top Eye (with sleeve) / Bottom Eye	I/O	Top Pin/Stud / Bottom Eye	O/I	Top Eye / Bottom Pin/Stud
O/I	Top Eye (with sleeve) / Bottom Pin/Stud	I/O	Top Pin/Stud / Bottom Eye (with sleeve)	O/O	Top Eye / Bottom Eye (with sleeve)

1. Please see the Cross Reference section of this catalog for a complete list of OE references.
2. Part number marked in **Bold Italic** represent the Premium, adjustable, heavy duty gas shock absorbers.

		FRONT				REAR			
		Mount	MERITOR	OE	REMARKS	Mount	MERITOR	OE	REMARKS

ISUZU

NHR

NHR54, NHR55, NHR57	84-86	I/O	M63211	8-94249333-1		O/O	M63299	5-51630048-1 8-94167460-1	
	86-89	I/O	M63211	8-94167458-0 8-94167458-1 9-51630665-2		O/O	M63173 M85012 M89413		16mm mount pins 19mm mount pins
NHR69 (ELF NZ)	95-	I/O		8-97031387-3 8-97031388-3 8-97048134-3 8-97076713-2 8-97106604-0 8-97106605-0 8-97106606-0 8-97106607-0 8-97106608-0 8-97160090-0 8-97160091-0	IFS	O/O	M63299		
NHR152 (ELF NZ)		I/O	M63211						

NHS (4x4)

NKC15C (ELF NZ)		I/O	69992		IFS				
-----------------	--	-----	-------	--	-----	--	--	--	--

NKR (4x2)

NKR55E (ELF NZ), NKR125 (ELF NZ)		I/O	M63320			O/O	M63178	9-51630661-0	16mm mount pins
						O/O	M85012 M89413	9-51630666-0	19mm mount pins

NKR150 (NKR57, NKR58, NKR59, NKR66, NKR69)

NKR150 (NKR57)	84-	I/O	M63211	9-51630665-2 9-51630665-3 8-97283613-0 8-97107985-0					
NKR150 (NKR57, NKR58, NKR59, NKR66)	85-92	I/O	M63211	9-51630665-2 9-51630665-3 8-97283613-0 8-97107985-0		O/O	M63299	5-51630048-1 8-94249402-1	
NKR150 (NKR58, NKR59, NKR66, NKR69)	93	I/O	M63320	8-97148908-0 8-97253614-0		O/O	M63178 M85012 M89413	9-51630661-0 8-97253651-0	16mm mount pins 19mm mount pins
	94-00	I/O	M63320 M63211	8-97148908-0 8-97253614-0 8-97253613-0 8-97107985-0					
NKR150 (NKR66) (SITEC 110)	00-	I/O	M63448	8-97083028-0 8-97201960-0					
	03-	I/O	M63448	8-97201960-0					



SYMBOLS

AIR	Air Suspension	TAP	Tapered Leaf Suspension	SS	Spring Suspension	TBS	Torsion Bar Suspension
PSS	Parabolic Spring Suspension	AEON	AEON Spring	TLS	Trapezium Leaf Suspension		
MLS	Multi Leaf Suspension	RBS	Rubber Block Suspension	IFS	Independant Front Suspension		

1. Please see the Cross Reference section of this catalog for a complete list of OE references.

2. Part number marked in **Bold Italic** represent the Premium, adjustable, heavy duty gas shock absorbers.



		FRONT				REAR			
		Mount	MERITOR	OE	REMARKS	Mount	MERITOR	OE	REMARKS

ISUZU

NKR200 (NKR57, NKR58, NKR59, NKR66, NKR69, NKR71)

NKR200 (NKR57)	84	I/O	M63211	9-51630665-2 9-51630665-3 8-97253613-0 8-97107985-0					
NKR200 (NKR57, NKR58, NKR59, NKR66)	85-92	I/O	M63211	9-51630665-2 9-51630665-3 8-97253613-0 8-97107985-0	medium, short & flat low	O/O	M63299	5-51630048-1 8-94249402-1	
	93	I/O	M63320	8-97148908-0 8-97253614-0	medium, short & flat low	O/O	M63178 M85012 M89413	9-51630661-0 8-97253651-0	16mm mount pins 19mm mount pins
NKR200 (NKR58, NKR59, NKR66, NKR69)	94-5/98	I/O	M63320	8-97148908-0 8-97253614-0	short & flat low				
NKR200 (NKR66, NKR69)	6/98-	I/O	M63320	8-97148908-0 8-97253614-0	medium, short & flat low	O/O	M63299	8-97253656-0	
NKR200 (NKR66) (SITEC 110)	7/00-	I/O	M63320	8-97148908-0 8-97253614-0	medium, short & flat low	O/O	M63299	8-97253656-0	
		I/O	M63448	8-97083028-0 8-97201960-0					
NKR200 (NKR71) (SITEC 125)	03-	I/O	M63320	8-97253605-0	flat, low & medium	O/O	M63299	8-97253656-0	
	05-	I/O		8-97253602-0 8-97253608-0	flat low, medium & short				

NKR250 (NKR58)

NKR250 (NKR58) inc. cre cab	85-92	I/O	M63211	9-51630665-2 9-51630665-3 8-97253613-0 8-97107985-0		O/O	M63299	5-51630048-1	
	93-	I/O	M63320	8-97148908-0 8-97253614-0					

NLR

NLR200 (4x2)

NLR200 (SITEC 150) Series II	08-				short & medium IFS	O/O	M85012 M89413	8-97253651-0	
------------------------------	-----	--	--	--	--------------------	-----	-------------------------	--------------	--

NNR (4x2)

NNR200

NNR200 (SITEC 150) Series II	08-				short, medium, crew	O/O	M85012 M89413	8-97253651-0	
------------------------------	-----	--	--	--	---------------------	-----	-------------------------	--------------	--



NPR (4x2)

NPR61L (NZ)		I/O	M63448	9-51630647-1		O/O	M85012 M89413	9-51630666-0	
NPR81 (NZ)	03					O/O	M85012 M89413	9-51630666-0	

MOUNTING DIAGRAMS

O/O	Top Eye (with sleeve) / Bottom Eye (with sleeve)	I/I	Top Pin/Stud / Bottom Pin/Stud	O/O	Top Eye / Bottom Eye
O/O	Top Eye (with sleeve) / Bottom Eye	I/O	Top Pin/Stud / Bottom Eye	O/I	Top Eye / Bottom Pin/Stud
O/I	Top Eye (with sleeve) / Bottom Pin/Stud	I/O	Top Pin/Stud / Bottom Eye (with sleeve)	O/O	Top Eye / Bottom Eye (with sleeve)

1. Please see the Cross Reference section of this catalog for a complete list of OE references.
2. Part number marked in **Bold Italic** represent the Premium, adjustable, heavy duty gas shock absorbers.

		FRONT				REAR			
		Mount	MERITOR	OE	REMARKS	Mount	MERITOR	OE	REMARKS

ISUZU

NPR200 (NPR57, NPR58, NPR59, NPR66, NPR70)

NPR200 (NPR57, NPR58, NPR59)	84-	I/O	M63448	8-97201960-0 9-51630647-1		O/O	M63178	9-51630661-0	16mm mount pins
							M85012 M89413	9-51630666-0	19mm mount pins
NPR200 (NPR58, NPR59, NPR66)	92-00	I/O	M63448	8-97201960-0	auto, medium & short	O/O	M85012 M89413	8-97160094-0 8-97253651-0	
NPR200 (NPR66) (SITEC 110)	00-	I/O	M63448	8-97201960-0	medium & short	O/O	M85012 M89413	8-97160094-0 8-97253651-0	
NPR200 (NPR70) (SITEC 125, 140)	03-	I/O	M63448	8-97201960-0	medium & short	O/O	M85012 M89413	8-97160094-0 8-97253651-0	
NPR200 (NPR70) (SITEC 150)	05-	I/O		8-97379628-0	medium & short	O/O	M85012 M89413	8-97160094-0 8-97253651-0	

NPR250 (NPR58, NPR59, NPR66, NPR70, NPR71)

NPR250 (NPR58, NPR59, NPR66)	93-95	I/O	M63448	8-97201960-0	auto, crew & medium	O/O	M85012 M89413	8-97160094-0 8-97253651-0	
NPR250 (NPR66, 71)	96-00	I/O	M63448	8-97201960-0	auto, crew & medium	O/O	M85012 M89413	8-97160094-0 8-97253651-0	
NPR250 (NPR71)	00-	I/O	M63448	8-97201960-0	auto, crew & medium	O/O	M85012 M89413	8-97160094-0 8-97253651-0	
				8-97287995-0					
NPR250 (NPR70) (SITEC 140, 170)	03-	I/O	M63448	8-97201960-0	auto, crew & medium	O/O	M85012 M89413	8-97160094-0 8-97253651-0	
NPR250 (NPR70) (SITEC 150)	05-	I/O		8-97379628-0	medium & crew	O/O	M85012 M89413	8-97253651-0	
NPR250 (4x2) (SITEC 155) Series II	08-	I/O		8-97379628-0	medium & crew	O/O	M85012 M89413	8-97253651-0	

NPR300 (NPR58, NPR59, NPR66, NPR70, NPR71)

NPR300 (NPR58, NPR59)	84-	I/O	M63448	8-97201960-0	STD & crew	O/O	M63178	9-51630661-0	16mm mount pins
							M85012 M89413	9-51630666-0	19mm mount pins
NPR300 (NPR58, NPR59, NPR66)	92-94	I/O	M63448	8-97201960-0	STD & crew	O/O	M85012 M89413	8-97160094-0	
	94-00	I/O	M63448	8-97201960-0	auto, crew & medium				
NPR300 (NPR71) (SITEC 110, 120)	00-	I/O	M63448	8-97201960-0	auto, crew & medium	O/O	M85012 M89413	8-97160094-0	
NPR300 (NPR70) (SITEC 140)	03-	I/O	M63448	8-97201960-0	auto, medium & long	O/O	M85012 M89413	8-97160094-0	
NPR300 (NPR70) (SITEC 150)	05-	I/O		8-97379628-0	medium & tipper	O/O	M85012 M89413	8-97160094-0	
NPR300 (4x2) (SITEC 155) Series II	08-	I/O		8-97379628-0	medium, crew, tipper, tipper crew	O/O	M85012 M89413	8-97160094-0	

SYMBOLS



AIR	Air Suspension	TAP	Tapered Leaf Suspension	SS	Spring Suspension	TBS	Torsion Bar Suspension
PSS	Parabolic Spring Suspension	AEON	AEON Spring	TLS	Trapezium Leaf Suspension		
MLS	Multi Leaf Suspension	RBS	Rubber Block Suspension	IFS	Independant Front Suspension		

1. Please see the Cross Reference section of this catalog for a complete list of OE references.

2. Part number marked in **Bold Italic** represent the Premium, adjustable, heavy duty gas shock absorbers.



www.meritorpartsonline.com

		FRONT				REAR			
		Mount	MERITOR	OE	REMARKS	Mount	MERITOR	OE	REMARKS

ISUZU

NPR350

NPR350 (NPR70) (SITEC 170)	03-	I/O	M63448	8-97201960-0					
-------------------------------	-----	-----	--------	--------------	--	--	--	--	--

NPR400 (NPR58, NPR59, NPR65, NPR66, NPR70, NPR71)

NPR400 (NPR58, NPR59)	84-	I/O	M63448	8-97201960-0	long, medium & turbo	O/O	M63178	9-51630661-0	16mm mount pins
							M85012 M89413	9-51630666-0	19mm mount pins
NPR400 (NPR58, NPR59, NPR66, NPR71)	92-00	I/O	M63448	8-97201960-0	long, medium & turbo	O/O	M85012 M89413	8-97160094-0 8-97253651-0	
NPR400 (NPR70) (SITEC 130)	00-	I/O	M63448	8-97201960-0	long, medium & turbo	O/O	M85012 M89413	8-97253651-0	
				8-97287995-0					
NPR400 (NPR70) (SITEC 140)	03-	I/O	M63448	8-97201960-0	long, medium & turbo	O/O	M85012 M89413	8-97253651-0	
				8-97287995-0					
NPR400 (NPR70) (SITEC 150)	05-	I/O		8-97376928-0	long, medium & turbo	O/O	M85012 M89413	8-97253651-0	

NPR450 (NPR66)

NPR450 (NPR66) NZ		I/O	M63448	8-97201960-0		O/O	M85012 M89413	8-97160094-0	
-------------------	--	-----	--------	--------------	--	-----	--------------------------------	--------------	--

NPS (4x4)

NPS250 (NPS70, NPS71)

NPS250 (NPS71) (SITEC 115)	00-	I/O	M63448	8-97201960-0					
NPS250 (NPS70) (SITEC 140)	03-	I/O	M63448	8-97201960-0					
NPS250 (NPS70) (SITEC 150)	05-	I/O		8-97367351-0		O/O	M85012 M89413	8-97253651-0	



NPS300 (NPS59, NPS 66, NPS 70, NPS 71)

NPS300 (NPS59, NPS66)	93-95	I/O	M63448	8-97201960-0					
NPS300 (NPS66, NPS71)	96-00	I/O	M63448	8-97033591-1		O/O	M85012 M89413	8-97160094-0	
				8-97201960-0				8-97253651-0	
NPS300 (NPS71) (SITEC 115)	00-	I/O	M63448	8-97201960-0		O/O	M85012 M89413	8-97160094-0 8-97253651-0	
NPS300 (NPS70) (SITEC 140)	03-	I/O	M63448	8-97201960-0		O/O	M85012 M89413	8-97160094-0 8-97253651-0	
NPS300 (NPS70) (SITEC 150)	05-	I/O		8-97367351-0		O/O	M85012 M89413	8-97253651-0	
NPS300 (4x4) (SITEC 155) Series II inc. crew cab	08-	I/O		8-97367351-0		O/O	M63450	8-97253643-0	

MOUNTING DIAGRAMS

O/O	Top Eye (with sleeve) / Bottom Eye (with sleeve)	I/I	Top Pin/Stud / Bottom Pin/Stud	O/O	Top Eye / Bottom Eye
O/O	Top Eye (with sleeve) / Bottom Eye	I/O	Top Pin/Stud / Bottom Eye	O/I	Top Eye / Bottom Pin/Stud
O/I	Top Eye (with sleeve) / Bottom Pin/Stud	I/O	Top Pin/Stud / Bottom Eye (with sleeve)	O/O	Top Eye / Bottom Eye (with sleeve)

1. Please see the Cross Reference section of this catalog for a complete list of OE references.
2. Part number marked in **Bold Italic** represent the Premium, adjustable, heavy duty gas shock absorbers.

		FRONT				REAR			
		Mount	MERITOR	OE	REMARKS	Mount	MERITOR	OE	REMARKS

ISUZU

NPS (4x4)

NPS400 (NPS70)

NPS400 (NZ)	02-	I/O	M63211	1-51630381-0 8-97253613-0 8-97107985-0	16mm lower mount	O/O	M85012 M89413	8-97160094-0 8-97253651-0	
			M63448	8-97033591-1	19mm lower mount				
NPS400 (NPS70) NZ (SITEC 150)	05-	I/O		8-97367351-0		O/O	M85012 M89413	8-97160094-0 8-97253651-0	

NQR (4x2)

NQR450 (NQR70)

NQR450 (NQR70) (SITEC 145)	98-	I/O	M63448	8-97033591-1 8-97083027-0 8-97201960-0	turbo & turbo custom	O/O	M85012 M89413	8-97160094-0 8-97253651-0	
NQR450 (NQR70) (SITEC 145)	00-	I/O	M63448	8-97201960-0	medium, long & long custom	O/O	M85012 M89413	8-97160094-0 8-97253651-0	
NQR450 (NQR70) (SITEC 170)	03-	I/O	M63448	8-97201960-0	medium & long	O/O	M85012 M89413	8-97160094-0 8-97253651-0	

NQR500

NQR500 (NZ)	00-	I/O	M63448			O/O	M85012 M89413	8-97160094-0 8-97253651-0	
-------------	-----	-----	--------	--	--	-----	-------------------------	------------------------------	--

NRR

NRR	88-90	I/O	M63211	1-51630217-0					
-----	-------	-----	--------	--------------	--	--	--	--	--

S

SBR372, SBR422, SBR450, SBR482	70-86	I/O	M63320	1-51630033-0 1-51630039-0 1-51630039-2		I/I	M83318	1-51630094-0 9-51630338-0	
SCR	76-80	I/O	M63320	1-51630033-0					
SCR420, SCR480, SCR700	80-88	I/O	M63320	1-51630033-0		I/I	M83318	1-51630094-0 9-51630338-0	
SFR	72-79	O/O	M85304	9-51630374-0					
SHG, SHH	80-83	I/O	76103	1-51630053-0 1-51630053-1 1-51630053-2					
SHG (6x2), SHH (8x4) Twin Steer	80-83	I/O	76103	1-51630053-0 1-51630053-1 1-51630053-2					
SHR, SHZ	80-83	I/O	76103	1-51630053-0 1-51630053-1 1-51630053-2					
SLR	79-	I/O	76103	1-51630053-0 1-51630053-1 1-51630053-2					
SPG540 (6x2) Twin Steer	75-78	O/O	M85308 M89422	1-51630011-0					

SYMBOLS



AIR	Air Suspension	TAP	Tapered Leaf Suspension	SS	Spring Suspension	TBS	Torsion Bar Suspension
PSS	Parabolic Spring Suspension	AEON	AEON Spring	TLS	Trapezium Leaf Suspension		
MLS	Multi Leaf Suspension	RBS	Rubber Block Suspension	IFS	Independant Front Suspension		

1. Please see the Cross Reference section of this catalog for a complete list of OE references.

2. Part number marked in **Bold Italic** represent the Premium, adjustable, heavy duty gas shock absorbers.



www.meritorpartsonline.com

		FRONT				REAR			
		Mount	MERITOR	OE	REMARKS	Mount	MERITOR	OE	REMARKS

ISUZU

S									
SPG541 Twin Steer	80-82	I/O	76103	1-51630053-0 1-51630053-1 1-51630053-2					
SPH710	79-	I/O	M85304	9-51630374-0					
SPH Twin Steer	79-	I/O	76103	1-51630053-0 1-51630053-1 1-51630053-2					
SPR	72-77	I/O	76103	1-51630053-0 1-51630053-1 1-51630053-2					

VPZ									
VPZ (NZ)	75-	O/O	M85001 M89410		MLS				

IVECO



Eurocargo									
ML75									
ML75E14		O/O	7207	98408702 98411158 99451728		O/O	2745	98408701 98411159 99451732	
ML100									
ML100E18		O/O	7207	98408700 98411160 99451729		O/O	2745 2492	98408701 90044012	Neway AIR
ML100E21P		O/O	7207	504052219 99451729	PSS sleeper cab AIR	O/O	2492	90044012	Neway AIR
ML120									
ML120E18		I/O	4405	4859825 98415096 98465078		I/O	4405	98408707 98411167 99465079	
ML120E24		I/O	4405	99465084		I/O	4405	98436446 99465087	
ML130									
ML130E18		I/O	4405	4859825 98415096 98465078		I/O	4405	98408707 98411167 99465079	
ML150									
ML150E18S		I/O	4405	98415096 98465078		I/O	4405	98447155 99465080	
ML150E23P, ML150E23FP		I/I	2555	98416656 99484511		I/O	4405	99465087 99487470	
ML150E23S		I/O	4405	98415096 98465078		I/O	4405	98447155 99465080	
ML150E24		I/I	2555	98416656 99484511		I/O	4405	99487470	AIR

MOUNTING DIAGRAMS

O/O	Top Eye (with sleeve) / Bottom Eye (with sleeve)	I/I	Top Pin/Stud / Bottom Pin/Stud	O/O	Top Eye / Bottom Eye
O/O	Top Eye (with sleeve) / Bottom Eye	I/O	Top Pin/Stud / Bottom Eye	O/I	Top Eye / Bottom Pin/Stud
O/I	Top Eye (with sleeve) / Bottom Pin/Stud	I/O	Top Pin/Stud / Bottom Eye (with sleeve)	O/O	Top Eye / Bottom Eye (with sleeve)

1. Please see the Cross Reference section of this catalog for a complete list of OE references.
2. Part number marked in **Bold Italic** represent the Premium, adjustable, heavy duty gas shock absorbers.



		FRONT				REAR			
		Mount	MERITOR	OE	REMARKS	Mount	MERITOR	OE	REMARKS



IVECO									
ML160									
ML160E28		I/O		504120116		I/O		908383341	AIR
ML170									
ML170E23		I/O	2571	98480455 99473748 99473750		I/O	4405	98436447 99473797	
ML170E27		I/O	2571	98493596 99473750		I/O	4405	98436447 99473797	
ML180									
ML180E28		I/O	2571	99473748		I/O	4405	99431723 99485542 99473797	AIR
ML230									
ML230E28		I/O	2571	99473750		I/O	4405	99473797	
Eurostar									
LD5500									
LD5500 (520HP)		I/O	2566	41218445	3 leaf PSS 16mm lower mount	O/O	M85013	47902-24 57905-001	Hendrickson HAS AIR
							M85909	90045132	Neway AD246 AIR
Eurotech									
MT3500									
MT3500 (340HP) (4x2, 6x4)		I/O	2566	41218445 99474655	16mm lower mount	O/O	M85013	47902-24 57905-001	Hendrickson HAS AIR
							M83207 M89407	47902-11	Hendrickson HN460 RBS
MP4100									
MP4100		I/O	2566	41214818	2 leaf PSS 16mm lower mount	O/O	M85013	47902-24 57905-001	Hendrickson HAS AIR
MP4300									
MP4300 (6x4)		I/O	2566	41214818	2 or 3 leaf PSS				
MP4300 (8x4)		I/O	40110	97134287		O/O	M85013	47902-24 57905-001	Hendrickson HAS AIR
							M85030 M89440	3501001 90045504	Neway AD246 AIR

SYMBOLS

AIR	Air Suspension	TAP	Tapered Leaf Suspension	SS	Spring Suspension	TBS	Torsion Bar Suspension
PSS	Parabolic Spring Suspension	AEON	AEON Spring	TLS	Trapezium Leaf Suspension		
MLS	Multi Leaf Suspension	RBS	Rubber Block Suspension	IFS	Independant Front Suspension		

1. Please see the Cross Reference section of this catalog for a complete list of OE references.

2. Part number marked in **Bold Italic** represent the Premium, adjustable, heavy duty gas shock absorbers.

		FRONT				REAR			
		Mount	MERITOR	OE	REMARKS	Mount	MERITOR	OE	REMARKS

IVECO

Eurotech

MP4500									
MP4500 (6x4)		I/O	2566	41218445		O/O	M85013	47902-24 57905-001	Hendrickson HAS AIR
							M85030 M89440	3501001 90045504	Neway AD246 AIR
MP4500 (8x4) Twin Steer		I/O	40110	97134287		O/O	M85013	47902-24 57905-001	Hendrickson HAS AIR
							M85030 M89440	3501001 90045504	Neway AD246 AIR

MP4700									
MP4700 (6x4) Series 1		O/O	40131	97136615	AIR	O/O	M85013	47902-24 57905-001	Hendrickson HAS AIR
							M83209 M89414	60675-003	
							M85909	90045132	Chassis ~ G Series Neway AD246 AIR
							M85030 M89440	3501001 90045504	Chassis G Series ~ Neway AD246 AIR
MP4700 (6x4) Series 2		O/O	40131	97136615	AIR	O/O	M85013	47902-24 57905-001 60675-005	Hendrickson HAS AIR
							M83209 M89414	60675-003	Hendrickson HAS AIR
							M85030 M89440	3501001 90045504	Neway AD246 AIR
MP4700 (8x4) Twin Steer		O/O	40131	97136615	AIR	O/O	M85013	47902-24 57905-001 60670-005	Hendrickson HAS AIR
							M85909	90045132	Neway AD246 AIR
							M85030 M89440	3501001 90045504	Neway AD246 AIR



Powerstar

6300									
		O/O		97134643	AEON	O/O	M85013	47902-24 57905-001 60670-005	Hendrickson HAS AIR
		O/O		3252043R2 97135133	MLS				
		I/O		97137446	3 leaf PSS				
		I/O			4 leaf PSS				

MOUNTING DIAGRAMS

O/O	Top Eye (with sleeve) / Bottom Eye (with sleeve)	I/I	Top Pin/Stud / Bottom Pin/Stud	O/O	Top Eye / Bottom Eye
O/O	Top Eye (with sleeve) / Bottom Eye	I/O	Top Pin/Stud / Bottom Eye	O/I	Top Eye / Bottom Pin/Stud
O/I	Top Eye (with sleeve) / Bottom Pin/Stud	I/O	Top Pin/Stud / Bottom Eye (with sleeve)	O/O	Top Eye / Bottom Eye (with sleeve)

1. Please see the Cross Reference section of this catalog for a complete list of OE references.
2. Part number marked in **Bold Italic** represent the Premium, adjustable, heavy duty gas shock absorbers.

		FRONT				REAR			
		Mount	MERITOR	OE	REMARKS	Mount	MERITOR	OE	REMARKS

IVECO

Powerstar

6500

Mount	MERITOR	OE	REMARKS	Mount	MERITOR	OE	REMARKS
O/O		97134643	AEON	O/O	M85013	47902-24 57905-001 60670-005	Hendrickson HAS AIR
					M85072	60657-3 60657-003	Hendrickson PAX Primax AIR
		3252043R2 97135133	MLS		M85909	90045132	Neway AD246 AIR
					M85030 M89440	3501001 90045504	Neway AD246 AIR

6700

Mount	MERITOR	OE	REMARKS	Mount	MERITOR	OE	REMARKS	
O/O		97134643	AEON	O/O	M85013	47902-24 57905-001 60670-005	Hendrickson HAS AIR	
					M85072	60657-3 60657-003	Hendrickson PAX Primax AIR	
					M85909	90045132	Neway AD246 AIR	
					M85030 M89440	3501001 90045504		
		3252043R2 97135133	MLS		O/O	M85013	47902-24 57905-001 60670-005	Hendrickson HAS AIR
						M85072	60657-3 60657-003	Hendrickson PAX Primax AIR
						M85909	90045132	Neway AD246 AIR
						M85030 M89440	3501001 90045504	
		97137446	3 leaf PSS		O/O	M85013	47902-24 57905-001 60670-005	Hendrickson HAS AIR
						M85072	60657-3 60657-003	Hendrickson PAX Primax AIR
						M85909	90045132	Neway AD246 AIR
						M85030 M89440	3501001 90045504	
97135133	4 leaf PSS	O/O	M85013	47902-24 57905-001 60670-005	Hendrickson HAS AIR			
			M85072	60657-3 60657-003	Hendrickson PAX Primax AIR			
			M85909	90045132	Neway AD246 AIR			
			M85030 M89440	3501001 90045504				

SYMBOLS



AIR	Air Suspension	TAP	Tapered Leaf Suspension	SS	Spring Suspension	TBS	Torsion Bar Suspension
PSS	Parabolic Spring Suspension	AEON	AEON Spring	TLS	Trapezium Leaf Suspension		
MLS	Multi Leaf Suspension	RBS	Rubber Block Suspension	IFS	Independant Front Suspension		

1. Please see the Cross Reference section of this catalog for a complete list of OE references.

2. Part number marked in **Bold Italic** represent the Premium, adjustable, heavy duty gas shock absorbers.



www.meritorpartsonline.com

		FRONT				REAR			
		Mount	MERITOR	OE	REMARKS	Mount	MERITOR	OE	REMARKS

IVECO



Powerstar

7500									
							M85013	47902-24 57905-001 60670-005	Hendrickson HAS AIR
		O/O		97134643	AEON	O/O	M85072	60657-3 60657-003	Hendrickson PAX Primax AIR
							M85909	90045132	Neway AD246 AIR
							M85030 M89440	3501001 90045504	
		O/O		3252043R2 97135133	MLS	O/O	M85013	47902-24 57905-001 60670-005	Hendrickson HAS AIR
							M85072	60657-3 60657-003	Hendrickson PAX Primax AIR
							M85909	90045132	Neway AD246 AIR
							M85030 M89440	3501001 90045504	
7700									
							M85013	47902-24 57905-001 60670-005	Hendrickson HAS AIR
		O/O		97134643	AEON	O/O	M85072	60657-3 60657-003	Hendrickson PAX Primax AIR
							M85909	90045132	Neway AD246 AIR
							M85030 M89440	3501001 90045504	
		O/O		3252043R2 97135133	MLS	O/O	M85013	47902-24 57905-001 60670-005	Hendrickson HAS AIR
							M85072	60657-3 60657-003	Hendrickson PAX Primax AIR
							M85909	90045132	Neway AD246 AIR
							M85030 M89440	3501001 90045504	
		O/O		97137446	3 leaf PSS	O/O	M85013	47902-24 57905-001 60670-005	Hendrickson HAS AIR
							M85072	60657-3 60657-003	Hendrickson PAX Primax AIR
							M85909	90045132	Neway AD246 AIR
							M85030 M89440	3501001 90045504	

MOUNTING DIAGRAMS

O/O	Top Eye (with sleeve) / Bottom Eye (with sleeve)	I/I	Top Pin/Stud / Bottom Pin/Stud	O/O	Top Eye / Bottom Eye
O/O	Top Eye (with sleeve) / Bottom Eye	I/O	Top Pin/Stud / Bottom Eye	O/I	Top Eye / Bottom Pin/Stud
O/I	Top Eye (with sleeve) / Bottom Pin/Stud	I/O	Top Pin/Stud / Bottom Eye (with sleeve)	O/O	Top Eye / Bottom Eye (with sleeve)

1. Please see the Cross Reference section of this catalog for a complete list of OE references.
2. Part number marked in **bold italic** represent the Premium, adjustable, heavy duty gas shock absorbers.

		FRONT				REAR			
		Mount	MERITOR	OE	REMARKS	Mount	MERITOR	OE	REMARKS

IVECO

Powerstar

ADN / ADT

	04-			97137446		O/O	M85013	47902-24 57905-001 60670-005L	Hendrickson HAS AIR
							M83144	60670-007L	
							M85072	60657-3 60657-003	Hendrickson PAX Primax AIR

Stralis

COE (6x4) (8x4)

AD, AS, AT (6x4)	04-		2566	41033038 41214460 41214818		O/O	M85013	47902-24 57905-001 60670-005L	Hendrickson HAS AIR
							M83144	60670-007L	
							M85072	60657-3 60657-003	Hendrickson PAX Primax AIR
AD, AT (8x4) T/S	04-		40110	97134287		O/O	M85013	47902-24 57905-001 60670-005L	Hendrickson HAS AIR
							M83144	60670-007L	
							M85072	60657-3 60657-003	Hendrickson PAX Primax AIR
ASL (6x4)	09-								

Turbostar

F3470	89-			42070690		O/O	M83101	3261400R91	International AIR
							M85013	47902-024	Hendrickson HAS AIR
							M85909	90045132	Neway AD246 AIR 10" ride height
F4470	89-	O/O		42070690		O/O	M83101	3261400R91	International AIR
							M85013	47902-024	Hendrickson HAS AIR
							M85909	90045132	Neway AD246 AIR 10" ride height
F5470		O/O		3287407R1		O/O	M83101	3261400R91	International AIR
							M85013	47902-024	Hendrickson HAS AIR
							M85909	90045132	Neway AD246 AIR 10" ride height

SYMBOLS



AIR	Air Suspension	TAP	Tapered Leaf Suspension	SS	Spring Suspension	TBS	Torsion Bar Suspension
PSS	Parabolic Spring Suspension	AEON	AEON Spring	TLS	Trapezium Leaf Suspension		
MLS	Multi Leaf Suspension	RBS	Rubber Block Suspension	IFS	Independant Front Suspension		

1. Please see the Cross Reference section of this catalog for a complete list of OE references.

2. Part number marked in **Bold Italic** represent the Premium, adjustable, heavy duty gas shock absorbers.



www.meritorpartsonline.com

		FRONT				REAR			
		Mount	MERITOR	OE	REMARKS	Mount	MERITOR	OE	REMARKS

KENWORTH

C500, C550R, C500T, C501T K100, K100C K100E, K100G (6x4, 8x4), K104, K104G, K108 (6x4, 8x4) L700, L710 T300 (4x2) T350 (6x4), T358 (6x4), T358A (6x4) (8x4) (10x4) T400 (6x4), T401 (6x4), T404 (6x4), T408 (6x4), T408 SAR (6x4) (8x4), T408 SAR (6x4) (8x4), T440 (6x4), T480 (6x4) T600 (6x4), T601 (6x4), T604 (6x4), T608 (6x4), T650 (6x4), T658 (6x4), T900 (6x4), T904 (6x4), T908 (6x4), T950 (6x4) S2, RAR W	O/O	M85007 M89412	665565		O/O	M85305 M89425	K374-4 K374-28	TBS		
		M85001 M89410	90-2209SP1	PSS	I/I	M85310 M89423	K374-7 K374-9 K374-29 K374-32	Airglide 100 AIR		
		M85001 M89410	90-2209SP2	MLS	I/I	M85900	665903 665944 70701 90-2477SP1 K374-41	Airglide 200, 400, 600 AIR 9" ride height		
		M85001 M89410	90-2209SP3	PSS	O/I		K374-43	Airglide 200, 400, 600 AIR 10.5" ride height		
					I/I	M85902	665906 665945			
				M83312 M89409	K374-3		I/I	M85902	K374-38	Hendrickson HAS200 AIR
							O/I		K374-44	
							O/O	M85013	47902-024 57905-001 60670-005	Hendrickson HAS400, HAS460 AIR
							O/O	M83144	60670-007L	
				M83312 M89409	K374-5		O/O	M85013	47902-24 57905-001 60670-005	Hendrickson PAX460 (dual axle), PAX690 (tri axle) AIR 8.5", 10" ride height
					K374-10		O/O	M83144	60670-007L	
				M85001 M89410	K374-11		O/O	M85072	60657-003 60657-003L 60657-005 98583-032	Hendrickson WD460 AIR (large body)
					K374-14				S-0886	
				M85031	K374-16		O/O	M85967	60665-011	Hendrickson WD460 AIR (slimline body)
				M85001 M89410	K374-26				S-0886	
				M85001 M89410	K374-27		O/O		S-0886	Hendrickson WD2 460 AIR
		M83312 M89409	K374-33		O/O	M83112	57241-3 57241-003	Hendrickson HN402 RBS		



OE numbers are not applicable to all Kenworth models - Check Front and Rear OE numbers separately

MOUNTING DIAGRAMS

O/O	Top Eye (with sleeve) / Bottom Eye (with sleeve)	I/I	Top Pin/Stud / Bottom Pin/Stud	O/O	Top Eye / Bottom Eye
O/O	Top Eye (with sleeve) / Bottom Eye	I/O	Top Pin/Stud / Bottom Eye	O/I	Top Eye / Bottom Pin/Stud
O/I	Top Eye (with sleeve) / Bottom Pin/Stud	I/O	Top Pin/Stud / Bottom Eye (with sleeve)	O/O	Top Eye / Bottom Eye (with sleeve)

1. Please see the Cross Reference section of this catalog for a complete list of OE references.
2. Part number marked in **Bold Italic** represent the Premium, adjustable, heavy duty gas shock absorbers.



		FRONT				REAR			
		Mount	MERITOR	OE	REMARKS	Mount	MERITOR	OE	REMARKS

KENWORTH									
C500, C550R, C500T, C501T K100, K100C K100E, K100G (6x4, 8x4), K104, K104G, K108 (6x4, 8x4) L700, L710 T300 (4x2) T350 (6x4), T358 (6x4), T358A (6x4) (8x4) (10x4) T400 (6x4), T401 (6x4), T404 (6x4), T408 (6x4), T408 SAR (6x4) (8x4), T408 SAR (6x4) (8x4), T440 (6x4), T480 (6x4) T600 (6x4), T601 (6x4), T604 (6x4), T608 (6x4), T650 (6x4), T658 (6x4) T900 (6x4), T904 (6x4), T908 (6x4), T950 (6x4) S2, RAR W	O/O	O/O	M85007 M89412	665565		O/O	M85909	90045132	Neway AD246-10" AIR (- 2000)
			M85001 M89410	90-2209SP1	PSS				
			M85001 M89410	90-2209SP2	MLS				
			M85001 M89410	90-2209SP3	PSS				
			M83312 M89409	K374-3					
			M83312 M89409	K374-5					
				K374-10					
			M85001 M89410	K374-11					
			M83312 M89409	K374-14					
			M85031	K374-16					
			M85001 M89410	K374-26					
			M85001 M89410	K374-27					
			M83312 M89409	K374-33					
M85030 M89440	3501001 90045504		O/O	M85030 M89440	3501001 90045504	Neway AD246-10" AIR (2000 -)			
M85030 M89440	3501001 90045504						Neway AD369-10" AIR		

OE numbers are not applicable to all Kenworth models - Check Front and Rear OE numbers separately

KIA

CERES TRUCK (NZ)	97-	O/O	M63299						
------------------	-----	-----	--------	--	--	--	--	--	--

LEYLAND

LYNX LX50/28 (NZ)	68-74	I/I	2555						
B1600 BOXER	71-78	O/O							
HARRIER (6x4), REIVER (8x4)	72-82	I/I	76034		O/O	M83104			
CHIEFTAN (NZ)	79	I/I	2555						

MACK

CH

	90-97	O/O	M83209 M89414	14QK29402M		O/O	M85906	14QK2107P1 14QK2107P2	SS34C, SS38C, SS441C, SS462C
			M85013	14QK29403M		O/O	M85013	47902-024 57905-001 60670-005L	Hendrickson HAS400, HAS460, HAS461 AIR
				14QK29404M		O/I	M83112	57241-003	Hendrickson HN402 RBS
				14QK29409M	PSS low ride height	O/O			Hendrickson HN402 (NZ only) RBS

SYMBOLS



AIR	Air Suspension	TAP	Tapered Leaf Suspension	SS	Spring Suspension	TBS	Torsion Bar Suspension
PSS	Parabolic Spring Suspension	AEON	AEON Spring	TLS	Trapezium Leaf Suspension		
MLS	Multi Leaf Suspension	RBS	Rubber Block Suspension	IFS	Independant Front Suspension		

1. Please see the Cross Reference section of this catalog for a complete list of OE references.

2. Part number marked in **Bold Italic** represent the Premium, adjustable, heavy duty gas shock absorbers.



www.meritorpartsonline.com

		FRONT				REAR			
		Mount	MERITOR	OE	REMARKS	Mount	MERITOR	OE	REMARKS

MACK

CH									
CH613 (NZ only)	O/O				O/O	M83123 M89405	47902-9 14QK393AM	Mack AL231 AIR	
					O/O	M85906	14QK414M (90045099)	Neway AD246-8.5" AIR	
					O/O	M85030 M89440	14QK39406M 21126793	Dana DR.462P, DR.463HD Neway AD246-10" AIR	
					O/O	M85909	14QK414M2 (90045132)	Mack NAS.36C, NAS.462C Neway AD246-10" AIR	
CH631 (NZ only)	O/O				O/O	M85909	14QK29406M	Meritor RT40-145GP, RT46-160GP Neway AD246-10" AIR	
					O/O	M85030 M89440	14QK39406M	Meritor RT-160GP Neway AD246-10" AIR	
					O/O	M85072	14QK429M2 21286399	Sisu Neway AD246-10" AIR	
					O/O		14QK39407M	Dana DR.462P, DR.463P Neway AD246-11" AIR	
CH689 (NZ only)	O/O		M85005 M89430		O/O	M85909	14QK29406M	Dana DS.521P Neway AD246-11" AIR	
					O/O	M85308	14QK39405M	Mack NAS.462 Neway AD246-11" AIR	
					O/O		14QK39407M		
					O/O	M85308	14QK39405M	Meritor RT46-160GP, RT50-160GP Neway AD246-11" AIR	
					O/O		14QK39407M	Mack NAS.462C Neway AD246-12" AIR	
					O/O		14QK29405M		
					O/O		14QK39404M		



Rear Suspension options are available in any combination for all models listed above

MOUNTING DIAGRAMS

O/O	Top Eye (with sleeve) / Bottom Eye (with sleeve)	I/I	Top Pin/Stud / Bottom Pin/Stud	O/O	Top Eye / Bottom Eye
O/O	Top Eye (with sleeve) / Bottom Eye	I/O	Top Pin/Stud / Bottom Eye	O/I	Top Eye / Bottom Pin/Stud
O/I	Top Eye (with sleeve) / Bottom Pin/Stud	I/O	Top Pin/Stud / Bottom Eye (with sleeve)	O/O	Top Eye / Bottom Eye (with sleeve)

1. Please see the Cross Reference section of this catalog for a complete list of OE references.
2. Part number marked in **Bold Italic** represent the Premium, adjustable, heavy duty gas shock absorbers.



		FRONT				REAR			
		Mount	MERITOR	OE	REMARKS	Mount	MERITOR	OE	REMARKS

MACK



CHR

Mount	MERITOR	OE	REMARKS	Mount	MERITOR	OE	REMARKS			
90-97	O/O	M83209 M89414	14QK29402M 14QK372M2			M85906	14QK2107P1 14QK2107P2	SS34C, SS38C, SS441C, SS462C		
					O/O	M85906	14QK414M (90045099)	Neway AD246-8.5" AIR		
					O/O	M85030 M89440	14QK39406M 21126793	Dana DR.462P, DR.463HD Neway AD246-10" AIR		
					O/O	M85909	14QK414M2 (90045132)	Mack NAS.36C, NAS.462C Neway AD246-10" AIR		
					O/O	M85909	14QK29406M	Meritor RT40-145GP, RT46-160GP Neway AD246-10" AIR		
					O/O	M85030 M89440	14QK39406M	Meritor RT-160GP Neway AD246-10" AIR		
				M85013	14QK29403M		O/O	M85072	14QK429M2 21286399	Sisu Neway AD246-10" AIR
							O/O		14QK39407M	Dana DR.462P, DR.463P Neway AD246-11" AIR
							O/O	M85909	14QK29406M	Dana DS.521P Neway AD246-11" AIR
							O/O	M85308	14QK39405M	Mack NAS.462 Neway AD246-11" AIR
							O/O		14QK39407M	
							O/O	M85308	14QK39405M	Meritor RT46-160GP, RT50-160GP Neway AD246-11" AIR
				M85005 M89430	14QK392BM		O/O		14QK29405M	Mack NAS.462C Neway AD246-12" AIR
							O/O		14QK39404M	
							O/O	M85013	47902-024 57905-001 60670-005L 14QK29408M	Hendrickson HAS400, HAS460, HAS461 AIR

Rear Suspension options are available in any combination for all models listed above - Check OE number for application

SYMBOLS							
AIR	Air Suspension	TAP	Tapered Leaf Suspension	SS	Spring Suspension	TBS	Torsion Bar Suspension
PSS	Parabolic Spring Suspension	AEON	AEON Spring	TLS	Trapezium Leaf Suspension		
MLS	Multi Leaf Suspension	RBS	Rubber Block Suspension	IFS	Independant Front Suspension		

1. Please see the Cross Reference section of this catalog for a complete list of OE references.
2. Part number marked in **Bold Italic** represent the Premium, adjustable, heavy duty gas shock absorbers.

		FRONT				REAR			
		Mount	MERITOR	OE	REMARKS	Mount	MERITOR	OE	REMARKS

MACK

CLR (R-700R)



Mount	MERITOR	OE	REMARKS	Mount	MERITOR	OE	REMARKS
					M85906	14QK2107P1 14QK2107P2	SS34C, SS38C, SS441C, SS462C
	M83209 M89414	14QK29402M		O/O	M85906	14QK414M (90045099)	Neway AD246-8.5" AIR
				O/O	M85030 M89440	14QK39406M 21126793	Dana DR.462P, DR.463HD Neway AD246-10" AIR
				O/O	M85909	14QK414M2 (90045132)	Mack NAS.36C, NAS.462C Neway AD246-10" AIR
	M85013	14QK29403M		O/O	M85909	14QK29406M	Meritor RT40-145GP, RT46-160GP Neway AD246-10" AIR
				O/O	M85030 M89440	14QK39406M	Meritor RT-160GP Neway AD246-10" AIR
		14QK29404M		O/O	M85072	14QK429M2 21286399	Sisu Neway AD246-10" AIR
90-97	O/O			O/O		14QK39407M	Dana DR.462P, DR.463P Neway AD246-11" AIR
	M85005 M89430	14QK392BM	PSS upgrade	O/O	M85909	14QK29406M	Dana DS.521P Neway AD246-11" AIR
				O/O	M85308	14QK39405M	Mack NAS.462 Neway AD246-11" AIR
				O/O		14QK39407M	
				O/O	M85308	14QK39405M	Meritor RT46-160GP, RT50-160GP Neway AD246-11" AIR
				O/O		14QK39407M	
				O/O		14QK29405M	Mack NAS.462C Neway AD246-12" AIR
		14QK29409M	PSS upgrade	O/O		14QK39404M	
				O/O	M85013	47902-024 57905-001 60670-005L 14QK29408M	Hendrickson HAS400, HAS460, HAS461 AIR

Rear Suspension options are available in any combination for all models listed above - Check OE number for application

MOUNTING DIAGRAMS

O/O	Top Eye (with sleeve) / Bottom Eye (with sleeve)	I/I	Top Pin/Stud / Bottom Pin/Stud	O/O	Top Eye / Bottom Eye
O/O	Top Eye (with sleeve) / Bottom Eye	I/O	Top Pin/Stud / Bottom Eye	O/I	Top Eye / Bottom Pin/Stud
O/I	Top Eye (with sleeve) / Bottom Pin/Stud	I/O	Top Pin/Stud / Bottom Eye (with sleeve)	O/O	Top Eye / Bottom Eye (with sleeve)

1. Please see the Cross Reference section of this catalog for a complete list of OE references.
2. Part number marked in **Bold Italic** represent the Premium, adjustable, heavy duty gas shock absorbers.

		FRONT				REAR			
		Mount	MERITOR	OE	REMARKS	Mount	MERITOR	OE	REMARKS

MACK



Cruiseline (S / R 700)

	76-85	O/O	M83209 M89414	14QK29402M		O/O	M89425	14QK142P1	SWD(L)-56C, SWD-57C
		O/O	M89425	14QK2115					

SYMBOLS

AIR	Air Suspension	TAP	Tapered Leaf Suspension	SS	Spring Suspension	TBS	Torsion Bar Suspension
PSS	Parabolic Spring Suspension	AEON	AEON Spring	TLS	Trapezium Leaf Suspension		
MLS	Multi Leaf Suspension	RBS	Rubber Block Suspension	IFS	Independant Front Suspension		

1. Please see the Cross Reference section of this catalog for a complete list of OE references.
2. Part number marked in **Bold Italic** represent the Premium, adjustable, heavy duty gas shock absorbers.

		FRONT				REAR			
		Mount	MERITOR	OE	REMARKS	Mount	MERITOR	OE	REMARKS

MACK

Granite (6x4) (8x4)



Mount	MERITOR	OE	REMARKS	Mount	MERITOR	OE	REMARKS	
08-	O/I	M85080	14QK3108M	PSS	O/O	M85013	60670-5 60670-005 60670-005L	Maxlite 40 AIR
					O/O	M85013	60670-5 60670-005 60670-005L	Mack AL460 AIR
					O/O	M85072	60657-3 60657-003 60657-7 60657-007	Mack AP460 AIR
					O/O	M85906	14QK414M (90045099)	Neway AD246-8.5" AIR
					O/O	M85030 M89440	14QK39406M 21126793	Dana DR.462P, DR.463HD Neway AD246-10" AIR
					O/O	M85909	14QK414M2 (90045132)	Mack NAS.36C, NAS.462C Neway AD246-10" AIR
					O/O	M85909	14QK29406M	Meritor RT40-145GP, RT46-160GP Neway AD246-10" AIR
					O/O	M85030 M89440	14QK39406M	Meritor RT-160GP Neway AD246-10" AIR
	O/O	2721	14QK3116M	MLS	O/O	M85072	14QK429M2 21286399	Sisu Neway AD246-10" AIR
					O/O		14QK39407M	Dana DR.462P, DR.463P Neway AD246-11" AIR
					O/O	M85909	14QK29406M	Dana DS.521P Neway AD246-11" AIR
					O/O	M85308	14QK39405M	Mack NAS.462 Neway AD246-11" AIR
					O/O		14QK39407M	
					O/O	M85308	14QK39405M	Meritor RT46-160GP, RT50-160GP Neway AD246-11" AIR
					O/O		14QK39407M	
					O/O		14QK29405M	Mack NAS.462C Neway AD246-12" AIR
O/O		14QK39404M						

Rear Suspension options are available in any combination for all models listed above - Check OE number for application

MOUNTING DIAGRAMS

O/O	Top Eye (with sleeve) / Bottom Eye (with sleeve)	I/I	Top Pin/Stud / Bottom Pin/Stud	O/O	Top Eye / Bottom Eye
O/O	Top Eye (with sleeve) / Bottom Eye	I/O	Top Pin/Stud / Bottom Eye	O/I	Top Eye / Bottom Pin/Stud
O/I	Top Eye (with sleeve) / Bottom Pin/Stud	I/O	Top Pin/Stud / Bottom Eye (with sleeve)	O/O	Top Eye / Bottom Eye (with sleeve)

1. Please see the Cross Reference section of this catalog for a complete list of OE references.
2. Part number marked in **Bold Italic** represent the Premium, adjustable, heavy duty gas shock absorbers.

		FRONT				REAR			
		Mount	MERITOR	OE	REMARKS	Mount	MERITOR	OE	REMARKS

MACK



FIR-700R (A8FR-700R)

	70-76	○/○	M83209 M89414	14QK372M2	inc. Twin Steer	○/○	M89425	14QK142P1	SWD(L)-56C, SWD-57C
--	-------	-----	-------------------------	-----------	-----------------	-----	---------------	-----------	------------------------

SYMBOLS

AIR	Air Suspension	TAP	Tapered Leaf Suspension	SS	Spring Suspension	TBS	Torsion Bar Suspension
PSS	Parabolic Spring Suspension	AEON	AEON Spring	TLS	Trapezium Leaf Suspension		
MLS	Multi Leaf Suspension	RBS	Rubber Block Suspension	IFS	Independant Front Suspension		

1. Please see the Cross Reference section of this catalog for a complete list of OE references.
2. Part number marked in **Bold Italic** represent the Premium, adjustable, heavy duty gas shock absorbers.

		FRONT				REAR			
		Mount	MERITOR	OE	REMARKS	Mount	MERITOR	OE	REMARKS

MACK

Fleetliner



Mount	MERITOR	OE	REMARKS	Mount	MERITOR	OE	REMARKS
O/O	M85001 M89410	14QK2107P1 14QK2107P2	SS34C, SS38C, SS441C, SS462C				
O/O	M85013	47902-024 57905-001 60670-005L 14QK29408M	Hendrickson HAS400, HAS461 AIR				
O/O	M85072	60657-003 14QK429M2 21341752	Hendrickson PAX460 (dual axle) AIR				
O/O	M85906	14QK414M (90045099)	Neway AD246-8.5" AIR				
O/O	M85030 M89440	14QK39406M 21126793	Dana DR.462P, DR.463HD Neway AD246-10" AIR				
O/O	M85909	14QK414M2 (90045132)	Mack NAS.36C, NAS.462C Neway AD246-10" AIR				
O/O	M85909	14QK29406M	Meritor RT40-145GP, RT46-160GP Neway AD246-10" AIR				
O/O	M85030 M89440	14QK39406M	Meritor RT-160GP Neway AD246-10" AIR				
O/O	M85072	14QK429M2 21286399	Sisu Neway AD246-10" AIR				
O/O		14QK39407M	Dana DR.462P, DR.463P Neway AD246-11" AIR				
O/O	M85909	14QK29406M	Dana DS.521P Neway AD246-11" AIR				
O/O	M85308	14QK39405M	Mack NAS.462 Neway AD246-11" AIR				
O/O		14QK39407M					
O/O	M85308	14QK39405M	Meritor RT46-160GP, RT50-160GP Neway AD246-11" AIR				
O/O		14QK39407M					
O/O		14QK29405M	Mack NAS.462C Neway AD246-12" AIR				
O/O		14QK39404M					

Rear Suspension options are available in any combination for all models listed above - Check OE number for application

MOUNTING DIAGRAMS

O/O	Top Eye (with sleeve) / Bottom Eye (with sleeve)	I/I	Top Pin/Stud / Bottom Pin/Stud	O/O	Top Eye / Bottom Eye
O/O	Top Eye (with sleeve) / Bottom Eye	I/O	Top Pin/Stud / Bottom Eye	O/I	Top Eye / Bottom Pin/Stud
O/I	Top Eye (with sleeve) / Bottom Pin/Stud	I/O	Top Pin/Stud / Bottom Eye (with sleeve)	O/O	Top Eye / Bottom Eye (with sleeve)

1. Please see the Cross Reference section of this catalog for a complete list of OE references.
2. Part number marked in **Bold Italic** represent the Premium, adjustable, heavy duty gas shock absorbers.

		FRONT				REAR			
		Mount	MERITOR	OE	REMARKS	Mount	MERITOR	OE	REMARKS

MACK

Magnum

	95-	I/I	7175	5010052920					
--	-----	-----	------	------------	--	--	--	--	--

Manager

		I/I	76034						
--	--	-----	-------	--	--	--	--	--	--

Maxter

		I/I	4344	5010095217					
--	--	-----	------	------------	--	--	--	--	--

MBR (R600)

8x4 Twin Steer		O/O	M89405	14QK366P1					
----------------	--	-----	---------------	-----------	--	--	--	--	--

MBR (R-700R)

	75-78	O/O	M83209 M89414	14QK372M2					
--	-------	-----	-------------------------	-----------	--	--	--	--	--

MCR MK1 (R-700R)

	81-84	O/O	M89425	14QK2115		O/O	M85001 M89410	14QK2107P1 14QK2107P2	SSB38C, SS441C
--	-------	-----	--------	----------	--	-----	-------------------------	--------------------------	-------------------

Metroliner (also refer CH)

MK1 & 2		O/O	M89425	14QK2115		O/O	M85013	47902-024 57905-001 60670-005L 14QK29408M	Hendrickson HAS400, HAS461 AIR
MK3 & 4	98-	O/O	M85005 M89430	14QK392BM	PSS	O/O	M83144	60670-7 60670-007	Hendrickson HAS400, HAS461 AIR
8x4 Twin Steer		O/O	M85919	60665-005	Hendrickson Parasteer AIR	O/O	M85013	60670-5 60670-005 60670-005L	Maxlite 40 AIR
8x4 Twin Steer (NZ only)		O/O	M85005 M89430	14QK392BM	1st & 2nd Axle	O/O	M85013	60670-5 60670-005 60670-005L	Mack AL460 AIR
	08-	O/I	M85080	14QK3108M 20863239	PSS	O/O	M83112	57241-003 60680-003 60680-003L	Hendrickson HN402 RBS
		O/O	2721	14QK3116M	MLS				

Rear Suspension options are available in any combination for all models listed above - Check OE number for application

MHR MK2

		O/O	M83209 M89414	14QK29402M 14QK372M2		O/O	M85001 M89410	14QK2107P1 14QK2107P2	SSB38C, SS441C
		O/O	M85001 M89410	14QK378M A1QK2113P5					
		O/O		14QK29404M					
Set Back Front Axle		O/O	M85013	14QK29403M					
8x4 Twin Steer		O/O	M89425	14QK2115					

SYMBOLS



AIR	Air Suspension	TAP	Tapered Leaf Suspension	SS	Spring Suspension	TBS	Torsion Bar Suspension
PSS	Parabolic Spring Suspension	AEON	AEON Spring	TLS	Trapezium Leaf Suspension		
MLS	Multi Leaf Suspension	RBS	Rubber Block Suspension	IFS	Independant Front Suspension		

1. Please see the Cross Reference section of this catalog for a complete list of OE references.

2. Part number marked in **Bold Italic** represent the Premium, adjustable, heavy duty gas shock absorbers.





www.meritorpartsonline.com

		FRONT				REAR			
		Mount	MERITOR	OE	REMARKS	Mount	MERITOR	OE	REMARKS

MACK									
MHR Ultraliner									
single & Twin Steer	86-	O/O	M89425	14QK2115		O/O	M85001 M89410	14QK2107P1 14QK2107P2	SS34C, SS38C, SSB38C
MHR613 (NZ)									
	96	O/O	M85010						
Midliner									
		I/I	76034	5000731488 5000790851		I/I		5000745029 5000790190	
Midlum									
MV12		I/O	2737	5010383497		O/I	4378	5010488160	PSS
MV14		I/O	2737	5010383497					
MV15 (4x4)		I/O		5010499313		I/O		501048156 7482052758	
MV16	03-	I/O	76108	5010600336	Single leaf PSS	O/I	4378	5010488160	3 leaf PSS
								5010630004	2 Bag Renault Airtronic AIR
				O/O	M85013	60670-005L	2 bag Hendrickson HAS AIR		
				O/I	4378	5010488160	2 leaf PSS	5010630004	2 Bag Renault Airtronic AIR
O/O	M85013	60670-005L	2 bag Hendrickson HAS AIR						
Midlum Extreme									
MV15 4x2	05-	I/O	76108	5010488147	2 leaf PSS	O/I	4378	5010488160	4 leaf PSS
MIR (R-700R)									
	75-80	O/O	M83209 M89414	14QK372M2		O/O	M85001 M89410	14QK2107P1 14QK2107P2	SS34C, SS38C
Premium									
4x2	98-	I/I	7175	5010383050		O/O	40138	5010383685	
							40140	5010294414	
6x2	98-	I/I	7175	5010383050		O/O	40138	5010294908 5010294909	
6x2/4	98-	I/I	7175	5010383050		O/O	40138	5010383685	Drive Axle
								5010383686	Lazy Axle

MOUNTING DIAGRAMS					
O/O	Top Eye (with sleeve) / Bottom Eye (with sleeve)	I/I	Top Pin/Stud / Bottom Pin/Stud	O/O	Top Eye / Bottom Eye
O/O	Top Eye (with sleeve) / Bottom Eye	I/O	Top Pin/Stud / Bottom Eye	O/I	Top Eye / Bottom Pin/Stud
O/I	Top Eye (with sleeve) / Bottom Pin/Stud	I/O	Top Pin/Stud / Bottom Eye (with sleeve)	O/O	Top Eye / Bottom Eye (with sleeve)

1. Please see the Cross Reference section of this catalog for a complete list of OE references.
2. Part number marked in **Bold Italic** represent the Premium, adjustable, heavy duty gas shock absorbers.

		FRONT				REAR			
		Mount	MERITOR	OE	REMARKS	Mount	MERITOR	OE	REMARKS

MACK

Quantum

6x4	97-8/98	I/I	7175	5010294413 5010383050 5010383694		○/○	M85013	57905-001 60670-005L 14QK29408M	Hendrickson HAS400, HAS460, HAS461 AIR STD ride height
						○/○	M83209 M89414	60675-003 60675-003L 14QK39408M	Hendrickson HAS400, HAS460, HAS461 AIR low ride height
6x4 (CH Chassis)	9/98-04	○/○	M85054	14QK29409M		○/I	M83112	57241-003	Hendrickson HN402, HN462 RBS
						○/○	M85072	60657-003 14QK429M2 21341752	Hendrickson PAX460 (dual axle) AIR
						○/○	M85906	14QK414M (90045099)	Neway AD246-8.5" AIR
8x4 Twin Steer		○/○	M85919	60665-005	Hendrickson Parasteer AIR	○/○	M85030 M89440	14QK39406M 21126793	Dana DR.462P, DR.463HD Neway AD246-10" AIR
						○/○	M85909	14QK414M2 (90045132)	Mack NAS.36C, NAS.462C Neway AD246-10" AIR
8x4 Twin Steer (NZ only)		○/○		14QK392BM	1st & 2nd Axle	○/○	M85909	14QK29406M	Meritor RT40-145GP, RT46-160GP Neway AD246-10" AIR
						○/○	M85030 M89440	14QK39406M	Meritor RT-160GP Neway AD246-10" AIR
						○/○	M85072	14QK429M2 21286399	Sisu Neway AD246-10" AIR



Rear Suspension options are available in any combination for all models listed above - Check OE number for application

SYMBOLS

AIR	Air Suspension	TAP	Tapered Leaf Suspension	SS	Spring Suspension	TBS	Torsion Bar Suspension
PSS	Parabolic Spring Suspension	AEON	AEON Spring	TLS	Trapezium Leaf Suspension		
MLS	Multi Leaf Suspension	RBS	Rubber Block Suspension	IFS	Independant Front Suspension		

1. Please see the Cross Reference section of this catalog for a complete list of OE references.

2. Part number marked in **Bold Italic** represent the Premium, adjustable, heavy duty gas shock absorbers.

		FRONT				REAR			
		Mount	MERITOR	OE	REMARKS	Mount	MERITOR	OE	REMARKS

MACK

Quantum									
6x4	97-8/98	I/I	7175	5010294413 5010383050 5010383694		O/O		14QK39407M	Dana DR.462P, DR.463P Neway AD246-11" AIR
6x4 (CH Chassis)	9/98-04	O/O	M85054	14QK29409M		O/O	M85909	14QK29406M	Dana DS.521P Neway AD246-11" AIR
						O/O	M85308	14QK39405M	Mack NAS.462 Neway AD246-11" AIR
8x4 Twin Steer		O/O	M85919	60665-005	Hendrickson Parasteer AIR	O/O		14QK39407M	Meritor RT46-160GP, RT50-160GP Neway AD246-11" AIR
						O/O	M85308	14QK39405M	
8x4 Twin Steer (NZ only)		O/O		14QK392BM	1st & 2nd Axle	O/O		14QK39407M	Mack NAS.462C Neway AD246-12" AIR
						O/O		14QK29405M	
						O/O		14QK39404M	

Rear Suspension options are available in any combination for all models listed above - Check OE number for application

R600 MK2

	80-85	O/O	M89425	14QK2115 14QK29402M		O/O	M85001 M89410	14QK2107P1 14QK2107P2	SS34C, SS363, SSB38C, SS441C/W
						O/O	M85007 M89412	14QK2113P4 14QK2113P6	ST38
						O/O	M85013	14QK29408M	Neway ARDST MK1
		O/O	M83209 M89414	14QK372M2	Set Back	O/O	M83209 M89414	14QK29401M	Neway ARDST MK2
						O/O	M85013	90044025	Neway ARDST-244 slimline body
						O/O	M83209 M89414	90044968	Neway ARDST-244 large body

Rear Suspension options are available in any combination for all models listed above - Check OE number for application

R600R (Flinstone)

	65-73	O/O	M83221	14QK2100 14QK2100P1 14QK2100P5		O/O	M89425	14QK142P1	SWD(L)-56, SWD-57C, SWD-58C, SWD-571
--	-------	-----	--------	--------------------------------------	--	-----	---------------	-----------	---

R600R (Unitised Front)

	69-73	O/O	M83221	14QK2100P1 14QK2100P5		O/O	M89425	14QK142P1	SWD(L)-56C SWD-57C/W
--	-------	-----	--------	--------------------------	--	-----	---------------	-----------	-------------------------

R700R



	69-73	O/O	M83221	14QK2100P1 14QK2100P5		O/O	M89425	14QK142P1	SWD(L)-56C, SWD- 57C SWD-58C
--	-------	-----	--------	--------------------------	--	-----	---------------	-----------	------------------------------------

MOUNTING DIAGRAMS

O/O	Top Eye (with sleeve) / Bottom Eye (with sleeve)	I/I	Top Pin/Stud / Bottom Pin/Stud	O/O	Top Eye / Bottom Eye
O/O	Top Eye (with sleeve) / Bottom Eye	I/O	Top Pin/Stud / Bottom Eye	O/I	Top Eye / Bottom Pin/Stud
O/I	Top Eye (with sleeve) / Bottom Pin/Stud	I/O	Top Pin/Stud / Bottom Eye (with sleeve)	O/O	Top Eye / Bottom Eye (with sleeve)

- Please see the Cross Reference section of this catalog for a complete list of OE references.
- Part number marked in **Bold Italic** represent the Premium, adjustable, heavy duty gas shock absorbers.



		FRONT				REAR			
		Mount	MERITOR	OE	REMARKS	Mount	MERITOR	OE	REMARKS

MACK

Superliner I / II / III

Mount	MERITOR	OE	REMARKS	Mount	MERITOR	OE	REMARKS	
08-	O/O	M89425	14QK2115	MLS	O/O	M85001 M89410	14QK2107P1 14QK2107P2	SS38C, SSB38C, SS58C, SS440C, SS441C, SS441 SW
					O/O	M85013	47902-024 57905-001 60670-005L 14QK29408M	Hendrickson HAS400, HAS461 AIR
					O/O	M83144	60670-7 60670-007	Hendrickson HAS400, HAS461 AIR
					O/O	M85013	60670-5 60670-005 60670-005L	Mack AL460 AIR
	O/O	M85005 M89430	14QK392B	LT Model PSS	O/O	M85072	60657-003	Hendrickson PAX460 (dual axle) AIR
					O/O	M85072	60657-3 60657-003 60657-7 60657-007	Mack AP460 AIR
					O/O	M85013	14QK29408M	Neway ARDST MK1
					O/O	M83209 M89414	14QK29401M	Neway ARDST MK2
	O/O	M85080	14QK3108M 20863239	PSS	O/O	M85013	90044025	Neway ARDST-244 slimline body
					O/O	M83209 M89414	90044968	Neway ARDST-244 large body
					O/O	M85906	14QK414M (90045099)	Neway AD246-8.5" AIR
					O/O	M85030 M89440	14QK39406M 21126793	Dana DR.462P, DR.463HD Neway AD246-10" AIR
	O/O	2721	14QK3116M	MLS	O/O	M85909	14QK414M2 (90045132)	Mack NAS.36C, NAS.462C Neway AD246-10" AIR
					O/O	M85909	14QK29406M	Meritor RT40-145GP, RT46-160GP Neway AD246-10" AIR
	O/O	M85030 M89440	14QK39406M	Meritor RT-160GP Neway AD246-10" AIR				

Rear Suspension options are available in any combination for all models listed above - Check OE number for application

SYMBOLS



AIR	Air Suspension	TAP	Tapered Leaf Suspension	SS	Spring Suspension	TBS	Torsion Bar Suspension
PSS	Parabolic Spring Suspension	AEON	AEON Spring	TLS	Trapezium Leaf Suspension		
MLS	Multi Leaf Suspension	RBS	Rubber Block Suspension	IFS	Independant Front Suspension		

1. Please see the Cross Reference section of this catalog for a complete list of OE references.

2. Part number marked in **Bold Italic** represent the Premium, adjustable, heavy duty gas shock absorbers.



www.meritorpartsonline.com

		FRONT				REAR			
		Mount	MERITOR	OE	REMARKS	Mount	MERITOR	OE	REMARKS

MACK

Superliner I / II / III

08-	O/O	M89425	14QK2115	MLS	O/O	M85072	14QK429M2 21286399	Sisu Neway AD246-10" AIR	
	O/O				O/O		14QK39407M	Dana DR.462P, DR.463P Neway AD246-11" AIR	
	O/O	M85005 M89430	14QK392B	LT Model PSS	O/O	M85909	14QK29406M	Dana DS.521P Neway AD246-11" AIR	
	O/O				O/O	M85308	14QK39405M	Mack NAS.462 Neway AD246-11" AIR	
	O/O				O/O		14QK39407M		
	O/O				O/O	M85308	14QK39405M	Meritor RT46-160GP, RT50-160GP Neway AD246-11" AIR	
	O/I	M85080	14QK3108M 20863239	PSS	O/O		14QK39407M		
	O/O				O/O		14QK29405M		Mack NAS.462C Neway AD246-12" AIR
	O/O				O/O		14QK39404M		
	O/O	2721		14QK3116M	MLS	O/O		14QK39403M	Dana DS.521P, Mack NAS.462C, Meritor RT52-185G, RT52-380G, RVI SA52/1845B AD252-11" AIR

Rear Suspension options are available in any combination for all models listed above - Check OE number for application

Titan



08-	O/O	M85013	14QK29403M		O/O	M85906	14QK414M (90045099)	Neway AD246-8.5" AIR
						M85030 M89440	14QK39406M 21126793	Dana DR.462P, DR.463HD Neway AD246-10" AIR
						M85909	14QK414M2 (90045132)	Mack NAS.36C, NAS.462C Neway AD246-10" AIR
	M85909	14QK29406M	Meritor RT40-145GP, RT46-160GP Neway AD246-10" AIR					
	M85030 M89440	14QK39406M	Meritor RT-160GP Neway AD246-10" AIR					
O/O	2721		14QK3116M	MLS				

Rear Suspension options are available in any combination for all models listed above - Check OE number for application

MOUNTING DIAGRAMS

O/O	Top Eye (with sleeve) / Bottom Eye (with sleeve)	I/I	Top Pin/Stud / Bottom Pin/Stud	O/O	Top Eye / Bottom Eye
O/O	Top Eye (with sleeve) / Bottom Eye	I/O	Top Pin/Stud / Bottom Eye	O/I	Top Eye / Bottom Pin/Stud
O/I	Top Eye (with sleeve) / Bottom Pin/Stud	I/O	Top Pin/Stud / Bottom Eye (with sleeve)	O/O	Top Eye / Bottom Eye (with sleeve)

1. Please see the Cross Reference section of this catalog for a complete list of OE references.
2. Part number marked in **Bold Italic** represent the Premium, adjustable, heavy duty gas shock absorbers.

		FRONT				REAR			
		Mount	MERITOR	OE	REMARKS	Mount	MERITOR	OE	REMARKS

MACK

Titan



Mount	MERITOR	OE	REMARKS	Mount	MERITOR	OE	REMARKS	
08-	O/O	M85013	14QK29403M		O/O	M85072	14QK429M2 21286399	Sisu Neway AD246-10" AIR
					O/O		14QK39407M	Dana DR.462P, DR.463P Neway AD246-11" AIR
					O/O	M85909	14QK29406M	Dana DS.521P Neway AD246-11" AIR
					O/O	M85308	14QK39405M	Mack NAS.462 Neway AD246-11" AIR
					O/O		14QK39407M	
					O/O	M85308	14QK39405M	Meritor RT46-160GP, RT50-160GP Neway AD246-11" AIR
					O/O		14QK39407M	
					O/O		14QK29405M	Mack NAS.462C Neway AD246-12" AIR
					O/O		14QK39404M	
	O/O		14QK39403M	Dana DS.521P, Mack NAS.462C, Meritor RT52-185G, RT52-380G, RVI SA52/1845B AD252-11" AIR				
	O/O		14QK39401M 14QK39403M	AD252 AIR				
	O/O	M85030 M89440	3501001	AD252-8.75", AD252-10" AIR (2001-)				
	O/O		14QK39403M	Dana DS.521P, Mack NAS.462C, Meritor RT52-185G, R.V.I SA52/1845B AD252-11" AIR				
	O/O	M85030 M89440	3501001	AD260-10" AIR				
	O/O	M85030 M89440	3501001 90045504	AD369-10" AIR				
	O/O		14QK29405M 14QK39404M	Mack NAS.692C AD369-12" AIR				
	O/O	M85030 M89440	3501001	AD390-8.75", AD390-10" AIR				
				MLS				

Rear Suspension options are available in any combination for all models listed above - Check OE number for application

SYMBOLS

AIR	Air Suspension	TAP	Tapered Leaf Suspension	SS	Spring Suspension	TBS	Torsion Bar Suspension
PSS	Parabolic Spring Suspension	AEON	AEON Spring	TLS	Trapezium Leaf Suspension		
MLS	Multi Leaf Suspension	RBS	Rubber Block Suspension	IFS	Independant Front Suspension		

1. Please see the Cross Reference section of this catalog for a complete list of OE references.
2. Part number marked in **Bold Italic** represent the Premium, adjustable, heavy duty gas shock absorbers.

		FRONT				REAR			
		Mount	MERITOR	OE	REMARKS	Mount	MERITOR	OE	REMARKS

MACK

Trident

Mount	MERITOR	OE	REMARKS	Mount	MERITOR	OE	REMARKS	
								Mount
08-	O/O	M85005 M89430	14QK392BM	PSS	O/O	M85013	47902-024 57905-001 60670-005L 14QK29408M	Hendrickson HAS400, HAS461 AIR
					O/O	M83144	60670-7 60670-007	Hendrickson HAS400, HAS461 AIR
			14QK29409M	Set Forward	O/O	M85013	60670-5 60670-005 60670-005L	Mack AL460 AIR
					O/O	M85072	60657-3 60657-003 60657-7 60657-007	Mack AP460 AIR
	O/I	M85080	14QK3108M 20863239	PSS	O/O	M85030 M89440	14QK39406M 21126793	Dana DR.462P, DR.463HD Neway AD246-10" AIR
					O/O	M85909	14QK414M2 (90045132)	Mack NAS.36C, NAS.462C Neway AD246-10" AIR
			21320856	Set Back PSS	O/O	M85909	14QK29406M	Meritor RT40-145GP, RT46-160GP Neway AD246-10" AIR
					O/O	M85030 M89440	14QK39406M	Meritor RT-160GP Neway AD246-10" AIR
	O/O	2721	14QK3116M	MLS	O/O	M85072	14QK429M2 21286399	Sisu Neway AD246-10" AIR

Rear Suspension options are available in any combination for all models listed above - Check OE number for application

Valueliner (R-600R)

Mount	MERITOR	OE	REMARKS	Mount	MERITOR	OE	REMARKS	
86-90	O/O	M89425	14QK2115		O/O	M85001 M89410	14QK2107P1 14QK2107P2	SS34C, SS38C, SSB38C, SS441C/W
	O/O	M85013	14QK29403M		Set Back	O/O	M85906	14QK414M (90045099)



Rear Suspension options are available in any combination for all models listed above - Check OE number for application

MOUNTING DIAGRAMS

O/O	Top Eye (with sleeve) / Bottom Eye (with sleeve)	I/I	Top Pin/Stud / Bottom Pin/Stud	O/O	Top Eye / Bottom Eye
O/O	Top Eye (with sleeve) / Bottom Eye	I/O	Top Pin/Stud / Bottom Eye	O/I	Top Eye / Bottom Pin/Stud
O/I	Top Eye (with sleeve) / Bottom Pin/Stud	I/O	Top Pin/Stud / Bottom Eye (with sleeve)	O/O	Top Eye / Bottom Eye (with sleeve)

1. Please see the Cross Reference section of this catalog for a complete list of OE references.
2. Part number marked in **Bold Italic** represent the Premium, adjustable, heavy duty gas shock absorbers.



		FRONT				REAR			
		Mount	MERITOR	OE	REMARKS	Mount	MERITOR	OE	REMARKS

MACK

Valueliner (R-700R)

	89-2/94	O/O	M83209 M89414	14QK29402M 14QK372M2	O/O	M85013	47902-024 57905-001 60670-005L 14QK29408M	Hendrickson HAS400, HAS461 AIR
			M85013	14QK29403M		M85906	14QK414M (90045099)	Neway AD246-8.5" AIR
			M85030 M89440	14QK39406M 21126793		M85030 M89440	14QK39406M 21126793	Dana DR.462P, DR.463HD Neway AD246-10" AIR
		M85005 M89430	14QK392BM	M85909		14QK414M2 (90045132)	Mack NAS.36C, NAS.462C Neway AD246-10" AIR	
			14QK29404M	M85909		14QK29406M	Meritor RT40-145GP, RT46-160GP Neway AD246-10" AIR	
			14QK29409M	M85030 M89440		14QK39406M	Meritor RT-160GP Neway AD246-10" AIR	
	98-	O/O	M85005 M89430	14QK392BM	M85072	14QK429M2 21286399	Sisu Neway AD246-10" AIR	
				14QK29404M				
				14QK29409M				

Rear Suspension options are available in any combination for all models listed above - Check OE number for application

Valueliner (R-700R)

	89-2/94	O/O	M83209 M89414	14QK29402M 14QK372M2	O/O		14QK39407M	Dana DR.462P, DR.463P Neway AD246-11" AIR	
			M85013	14QK29403M		M85909	14QK29406M	Dana DS.521P Neway AD246-11" AIR	
			M85005 M89430	14QK392BM		M85308	14QK39405M	Mack NAS.462 Neway AD246-11" AIR	
			14QK29404M	M85308		14QK39405M	Meritor RT46-160GP, RT50-160GP Neway AD246-11" AIR		
			14QK29409M			14QK39407M			
						14QK29405M	Mack NAS.462C Neway AD246-12" AIR		
	98-	O/O							

Rear Suspension options are available in any combination for all models listed above - Check OE number for application

SYMBOLS



AIR	Air Suspension	TAP	Tapered Leaf Suspension	SS	Spring Suspension	TBS	Torsion Bar Suspension
PSS	Parabolic Spring Suspension	AEON	AEON Spring	TLS	Trapezium Leaf Suspension		
MLS	Multi Leaf Suspension	RBS	Rubber Block Suspension	IFS	Independant Front Suspension		

1. Please see the Cross Reference section of this catalog for a complete list of OE references.

2. Part number marked in **Bold Italic** represent the Premium, adjustable, heavy duty gas shock absorbers.



www.meritorpartsonline.com

		FRONT				REAR			
		Mount	MERITOR	OE	REMARKS	Mount	MERITOR	OE	REMARKS

MACK

Vision									
		O/O	M85005 M89430	14QK392BM	3 leaf PSS	O/O	M85013	60670-005L	Hendrickson HAS200 (4x2), HAS381 (4x2), AIR
						O/O	M85013	60670-005L	Hendrickson HAS400 (6x4), HAS461 (6x4) AIR
						O/O	M83144	60670-7 60670-007	



MAN

6 & 7									
6.50 FC, 6.50 NC, 7.215, 7.8 FC, 7.8 NC		O/O	77003						
8									
8.135 F		I/I	7175	81.43701.6781 81.43701.6789		O/O	2723	81.43701.6782	
8.156 FC, 8.160 FC		O/O	77003	81.43701.6144		O/O	2722	81.43701.6610	AIR
8.160 F, FK, FS		I/I	7175	81.43701.6821					
9									
9.186 9.215 F, FK, FS		O/O	77003	81.43701.6144					
10									
10.136 (4x4)		I/I	7175	81.43701.6392 81.43701.6410		O/O	2723	81.43701.6338 81.43701.6452	
10.150 F (4x2) 10.153 FC (4x2), 10.160		I/I	7175	81.43701.6392 81.43701.6410		O/O	2723	81.43701.6338 81.43701.6452	SS
							2722	81.43701.6610	AIR
10.220 FOCL (4x2)		I/I	7175	81.43701.6781 81.43701.6789					
10.223 FC (4x2)	96-	I/I	7175	81.43701.6781		O/O	2721	81.43701.6784 81.43701.6798	AIR
10.223 L2000		I/I	7175	81.43701.6781		O/O	2721	81.43701.6798	AIR
10.223 (4x4)		I/O	7243	81.43701.6804				81.43701.6805	

MOUNTING DIAGRAMS

O/O	Top Eye (with sleeve) / Bottom Eye (with sleeve)	I/I	Top Pin/Stud / Bottom Pin/Stud	O/O	Top Eye / Bottom Eye
O/O	Top Eye (with sleeve) / Bottom Eye	I/O	Top Pin/Stud / Bottom Eye	O/I	Top Eye / Bottom Pin/Stud
O/I	Top Eye (with sleeve) / Bottom Pin/Stud	I/O	Top Pin/Stud / Bottom Eye (with sleeve)	O/O	Top Eye / Bottom Eye (with sleeve)

1. Please see the Cross Reference section of this catalog for a complete list of OE references.
2. Part number marked in **Bold Italic** represent the Premium, adjustable, heavy duty gas shock absorbers.

		FRONT				REAR			
		Mount	MERITOR	OE	REMARKS	Mount	MERITOR	OE	REMARKS

MAN

12									
12.135 FR, 12.215 DFR		O/O	M83101	81.43701.6503					
12.223 FC L2000	95-	I/O	7243	81.43701.6793 81.43701.6804		I/I	2723	81.43701.6782	SS
		I/I	7175	81.43701.6819		O/O	40131	81.43701.6866	AIR
12.223 L (4x2)	95-	I/O	7243	81.43701.6793 81.43701.6804		I/I	7175	81.43701.6808	
12.223 LL (4x2)	95-	I/I	7175	81.43701.6781 81.43701.6789 81.43701.6819		I/I	2723	81.43701.6782	SS
		I/O	7243	81.43701.6793 81.43701.6804		O/Ø	40164	81.43701.6790	AIR
12.224 L (4x2)	95-	I/O	7243	81.43701.6793 81.43701.6804		I/I	7175	81.43701.6808	
12.224 LL (4x2)	95-	I/I	7175	81.43701.6789		O/Ø	40164	81.43701.6790	AIR
		I/O	7243	81.43701.6793 81.43701.6804					
12.233		I/I	7175	81.43701.6789					
13									
13.168 F, H 13.192 F, FC		O/O	M83101	81.43701.6503		O/Ø	50128	81.43701.6142	SS
			77003	81.43701.6535					
14									
14.215 FC 14.230 FC, NC		O/O	77003	81.43701.6535					
14.304 DFR-SKD		O/O	M83101	81.43701.6503					
15									
15.168 F 15.168 FK, FS 15.168 H, HA HOCSKD		O/O	M83101	81.43701.6503					
			77003	81.43701.6144					
15.192 F, FK, FL, FS		O/O	77003	81.43701.6144					
			I/I	7175	81.43701.6630				
15.192 H, HA		O/O	M83101	81.43701.6503					
15.200 FOC		O/O	7188	81.43701.6426					
15.200 H		O/O	M83101	81.43701.6503					
15.223 (4x2) L, LL (L2000)	96-	I/O	7243	81.43701.6793		I/I	7175	81.43701.6808	SS (L Model)
						O/Ø	40164	81.43701.6790	AIR (L Model)
15.224 L, LL (4x2)	99-	I/O	7243	81.43701.6793		I/I	7175	81.43701.6808	SS (L Model)
						O/Ø	40164	81.43701.6790	AIR (LL Model)
15.240 F, H, HA		O/O	M83101	81.43701.6503					
15.263 (4x2) L, LL	96-	I/O	7243	81.43701.6793		I/I	7175	81.43701.6808	SS (L Model)
						O/Ø	40164	81.43701.6790	AIR (LL Model)
15.264 (NZ)		I/O	7243						
15.280 NC		I/O	7243	81.43701.6793					
15.284 FC (4x2)	99-	I/O	7243	81.43701.6793					

SYMBOLS



AIR	Air Suspension	TAP	Tapered Leaf Suspension	SS	Spring Suspension	TBS	Torsion Bar Suspension
PSS	Parabolic Spring Suspension	AEON	AEON Spring	TLS	Trapezium Leaf Suspension		
MLS	Multi Leaf Suspension	RBS	Rubber Block Suspension	IFS	Independant Front Suspension		

1. Please see the Cross Reference section of this catalog for a complete list of OE references.

2. Part number marked in **Bold Italic** represent the Premium, adjustable, heavy duty gas shock absorbers.



www.meritorpartsonline.com

		FRONT				REAR			
		Mount	MERITOR	OE	REMARKS	Mount	MERITOR	OE	REMARKS

MAN



16									
16.168 F, 16.168 FKO		O/O	77003	81.43701.6346 81.43701.6535					
16.168 H, 16.168 HA		O/O	M83101	81.43701.6503					
16.192 F		O/O	77003	81.43701.6535					
16.192 F-FKO, 16.192 FL-FKO	- 2/85	O/O	77003	81.43701.6346 81.43701.6348		O/E		81.43701.6177 81.43701.6419	
	3/85-	I/O	7243	81.43701.6491					
16.192 H		O/O	M83101	81.43701.6503					
16.200 F		O/O	77003	81.43701.6535					
16.200 H		O/O	M83101	81.43701.6503					
16.240 FA, 16.240 FOCR	- 2/85	O/O	77003	81.43701.6348					
	3/85-	I/O	7243	81.43701.6491					
16.240 H, 16.240 HR		O/O	M83101	81.43701.6503					
16.256 F, 16.256 FK, 16.256 FS		O/O	77003	81.43701.6346 81.43701.6535					
16.256 H		O/O	M83101	81.43701.6503					
16.256 UL		O/E	4343	81.43701.6178 81.43701.6418		4342	81.43701.6177	Drive Axle	SS
					4343	81.43701.6178	tag axle		
16.262 F, 16.262 FL		I/O	7243	81.43701.6491		I/I	4347	81.43701.6492	SS (F Model)
					O/O	40021	81.43701.6620	SS (FL Model)	
16.262 FLL		I/I	4347	81.43701.6612		O/O	40021	81.43701.6620	SS
16.292 F, 16.292 FL		I/O	7243	81.43701.6491		I/I	4347	81.43701.6492	SS (F Model)
					O/O	40021	81.43701.6620	SS (FL Model)	
16.292 FLL		I/I	4347	81.43701.6612		O/O	40021	81.43701.6620	SS (FLL Model)
16.320 F, 16.320 FA, 16.320 FL, 16.320 FLL, 16.320 FS		O/O	77003	81.43701.6346 81.43701.6535					
16.320 H		O/O	M83101	81.43701.6503					
16.332 (F03) F, 16.332 (F03) FL, 16.332 (F03) FLL		I/O	7243	81.43701.6491		I/I	4347	81.43701.6492	SS
					O/O	40021	81.43701.6620		
16.332 U (4x2)	-5/90	I/O	7243	81.43701.6491		I/I	4347	81.43701.6492 81.43701.6634	SS
16.332 ULL		I/I	4347	81.43701.6612 81.43701.6633		O/O	40021	81.43701.6620 81.43701.6634	
16.362 F, 16.362 FL, 16.362 U		I/O	7243	81.43701.6491		I/I	4347	81.43701.6492	SS
					O/O	40021	81.43701.6620		
16.362 FLL, 16.362 ULL		I/I	4347	81.43701.6612 81.43701.6633		O/O	40021	81.43701.6620	
16.462 F, 16.462 FL		I/O	7243	81.43701.6491		I/I	4347	81.43701.6492	SS (F Model)
					O/O	40021	81.43701.6620	SS (FL Model)	
16.462 FLL		I/I	4347	81.43701.6612		O/O	40021	81.43701.6620	SS

MOUNTING DIAGRAMS

O/O	Top Eye (with sleeve) / Bottom Eye (with sleeve)	I/I	Top Pin/Stud / Bottom Pin/Stud	O/O	Top Eye / Bottom Eye
O/O	Top Eye (with sleeve) / Bottom Eye	I/O	Top Pin/Stud / Bottom Eye	O/I	Top Eye / Bottom Pin/Stud
O/I	Top Eye (with sleeve) / Bottom Pin/Stud	I/O	Top Pin/Stud / Bottom Eye (with sleeve)	O/O	Top Eye / Bottom Eye (with sleeve)

1. Please see the Cross Reference section of this catalog for a complete list of OE references.
2. Part number marked in **Italic** represent the Premium, adjustable, heavy duty gas shock absorbers.



		FRONT				REAR			
		Mount	MERITOR	OE	REMARKS	Mount	MERITOR	OE	REMARKS

MAN

18

18.192 F, FL		I/I	7175	81.43701.6630 81.43701.6631		I/I	4347	81.43701.6622	SS (F Model)
18.192 FLL		I/I	4347	81.43701.6612		O/Θ	40136	81.43701.6658	AIR (FL Model)
18.192 (8x4)		I/I	4347	81.43701.6612					
18.220 FOC		I/O	7243	81.43701.6751					
18.223 (4x2) (4x4) L, 18.223 (4x2) (4x4) LA, 18.223 (4x2) (4x4) LL	95-	I/O	7243	81.43701.6793 81.43701.6804					
		I/I	4347	81.43701.6612					
18.223 (4x2) LLL	95-	I/I	4347	81.43701.6612		I/I	4347	81.43701.6622	SS
						O/O	40021	81.43701.6827	AIR
18.224 (4x2) (4x4) L, 18.224 (4x2) (4x4) LA, 18.224 (4x2) (4x4) LL		I/O	7243	81.43701.6793 81.43701.6804		I/I	4347	81.43701.6622	SS
18.224 (4x2) LLL		I/I	4347	81.43701.6612		O/O	40021	81.43701.6827	AIR
18.263 (4x2) (4x4) FC, 18.263 (4x2) (4x4) L, 18.263 (4x2) (4x4) LA, 18.263 (4x2) (4x4) LL		I/O	7243	81.43701.6793 81.43701.6804		I/I	4347	81.43701.6622	SS
18.263 (4x2) LLL		I/I	4347	81.43701.6612		O/O	40021	81.43701.6827	AIR
18.264 (4x2) (4x4) L, LA, LL		I/O	7243	81.43701.6793 81.43701.6804		I/I	4347	81.43701.6622	SS
18.264 (4x2) LLL		I/I	4347	81.43701.6612		O/O	40021	81.43701.6827	AIR
18.284 (4x4)		I/O	7243	81.43701.6804					

19

19.168 H/HA, 19.192 H/HA, 19.200 H/HA		O/O	M83101	81.43701.6503					
19.200 F, 19.240 F		O/O	77003	81.43701.6535					
19.240 FA		O/O	77003	81.43701.6348					
	3/85-	I/O	7243	81.43701.6491					
19.240 H/HR		O/O	M83101	81.43701.6503					
19.256 F		O/O	77003	81.43701.6346					
19.256 H		O/O	M83101	81.43701.6503					
19.262 F/FL		I/O	7243	81.43701.6491		O/O	40021	81.43701.6620 81.43701.6634 81.43701.6827	SS
19.262 FLL		I/I	4347	81.43701.6633		O/O	40021	81.43701.6620 81.43701.6634 81.43701.6827	SS
19.320 F/FA/FK/FR		O/O	77003	81.43701.6346 81.43701.6535					
			7188	81.43701.6426					
19.230 H		O/O	M83101	81.43701.6503					

SYMBOLS



AIR	Air Suspension	TAP	Tapered Leaf Suspension	SS	Spring Suspension	TBS	Torsion Bar Suspension
PSS	Parabolic Spring Suspension	AEON	AEON Spring	TLS	Trapezium Leaf Suspension		
MLS	Multi Leaf Suspension	RBS	Rubber Block Suspension	IFS	Independant Front Suspension		

1. Please see the Cross Reference section of this catalog for a complete list of OE references.

2. Part number marked in **Bold Italic** represent the Premium, adjustable, heavy duty gas shock absorbers.



www.meritorpartsonline.com

		FRONT				REAR			
		Mount	MERITOR	OE	REMARKS	Mount	MERITOR	OE	REMARKS

MAN

19

19.332 F, 19.332 FL, 19.332 U		I/O	7243	81.43701.6491		O/O	40021	81.43701.6620 81.43701.6634 81.43701.6827	SS
		I/I	4347	81.43701.6612 81.43701.6633		I/I	4347	81.43701.6492	AIR
19.332 FLL, 19.332 ULL		I/I	4347	81.43701.6612 81.43701.6633		O/O	40021	81.43701.6620 81.43701.6634 81.43701.6827	SS
						I/I	4347	81.43701.6492	AIR
19.362 F, 19.332 FL, 19.332 U, 19.332 FLL, 19.332 ULL		I/O	7243	81.43701.6491		O/O	40021	81.43701.6620 81.43701.6634 81.43701.6827	SS
		I/I	4347	81.43701.6612 81.43701.6633		I/I	4347	81.43701.6492	AIR
19.462 F, 19.462 FL		I/O	7243	81.43701.6491		O/O	40021	81.43701.6620	SS
						I/I	4347	81.43701.6492	SS
19.462 FLL		I/I	4347	81.43701.6612		O/O	40021	81.43701.6620	SS
						I/I	4347	81.43701.6492	SS
						O/O	40021	81.43701.6620	AIR

20

20.192 DH, 20.192 NC		O/O	M83101	81.43701.6503		O/Ø	50128	81.43701.6142 81.43701.6177	SS
20.280 (8x4) FC, 20.280 (8x4) FVLS		O/O	77003	81.43701.6346		O/Ø	4343	81.43701.6178 81.43701.6418	SS

22



22.192 DH		O/O	M83101	81.43701.6503					
22.192 FNL		O/O	77003	81.43701.6346					
22.223 (6x2) L2000		I/O	7243	81.43701.6491					
22.262 (6x4) DF, 22.262 (6x4) DFL		I/O	7243	81.43701.6491		O/O	40021	81.43701.6620	AIR
22.262 (6x2) FNL		I/O	7243	81.43701.6491		O/O	40021	81.43701.6620	Drive Axle AIR
22.262 (6x2) FNLL		I/I	4347	81.43701.6612		O/O	4020	81.43701.6605	tag axle
22.262 (6x2/4) FVL		I/O	7243	81.43701.6491 81.43701.6751		I/I	4347	81.43701.6612	Drive Axle AIR
						O/O	40021	81.43701.6620	tag axle
22.263 (6x2)	97-	I/O	7243	81.43701.6491 81.43701.6751		O/Ø	50128	81.43701.6142 81.43701.6177	Drive Axle AIR
22.264 (6x4)	99-	I/O	7243	81.43701.6793					

MOUNTING DIAGRAMS

O/O	Top Eye (with sleeve) / Bottom Eye (with sleeve)	I/I	Top Pin/Stud / Bottom Pin/Stud	O/O	Top Eye / Bottom Eye
O/O	Top Eye (with sleeve) / Bottom Eye	I/O	Top Pin/Stud / Bottom Eye	O/I	Top Eye / Bottom Pin/Stud
O/I	Top Eye (with sleeve) / Bottom Pin/Stud	I/O	Top Pin/Stud / Bottom Eye (with sleeve)	O/O	Top Eye / Bottom Eye (with sleeve)

- Please see the Cross Reference section of this catalog for a complete list of OE references.
- Part number marked in **Italic** represent the Premium, adjustable, heavy duty gas shock absorbers.



		FRONT				REAR			
		Mount	MERITOR	OE	REMARKS	Mount	MERITOR	OE	REMARKS

MAN

22									
22.280 FNL (6x2)		O/O	7188	81.43701.6426			4342	81.43701.6177	Drive Axle AIR
		O/E	4343	81.43701.6178 81.43701.6418		O/E	4343	81.43701.6178 81.43701.6418	tag axle
22.292 (6x4) DF, 22.292 (6x4) DFL		I/O	7243	81.43701.6491 81.43701.6751		O/O	40021	81.43701.6620 81.43701.6634	AIR
22.292 (6x2/4) FVL		I/O	7243	81.43701.6491 81.43701.6751		I/I	4347	81.43701.6612	Drive Axle AIR
						O/O	40021	81.43701.6620	tag axle
22.292 (6x2) FNL		I/O	7243	81.43701.6491 81.43701.6751		O/O	40021	81.43701.6620	Drive Axle AIR
							4020	81.43701.6605	tag axle
22.292 (6x2) FNLL		I/I	4347	81.43701.6612		O/O	40021	81.43701.6620	Drive Axle AIR
							4020	81.43701.6605	tag axle
22.320 (6x2) FNL		O/E	4343	81.43701.6178 81.43701.6418		O/E	4342	81.43701.6177	Drive Axle SS
		O/O	77003	81.43701.6535			4343	81.43701.6178 81.43701.6418	tag axle
22.332 (6x4) DF, 22.332 (6x4) DFL	- 4/91	I/O	7243	81.43701.6491 81.43701.6751		O/O	40021	81.43701.6620 81.43701.6634 81.43701.6721 81.43701.6722	AIR
22.332 (6x2) FNL, 22.332 (6x2) UNL		I/O	7243	81.43701.6491 81.43701.6751		O/O	40021	81.43701.6620 81.43701.6634	Drive Axle AIR
							4020	81.43701.6605	tag axle
22.332 (6x2/4) FVL		I/O	7243	81.43701.6491 81.43701.6751		I/I	4347	81.43701.6612	Drive Axle AIR
						O/O	40021	81.43701.6620	tag axle
22.332 (6x2) FNLL, 22.332 (6x2) UNLL		I/I	4347	81.43701.6612 81.43701.6633		O/O	40021	81.43701.6620 81.43701.6634	Drive Axle AIR
							4020	81.43701.6605	tag axle
22.362 (6x4) DF, 22.362 (6x4) DFL		I/O	7243	81.43701.6491 81.43701.6751 81.43701.6699		O/O	40021	81.43701.6620 81.43701.6634 81.43701.6721 81.43701.6722	AIR
22.362 (6x2) FNL, 22.362 (6x2) UNL		I/O	7243	81.43701.6491 81.43701.6751 81.43701.6699		O/O	40021	81.43701.6620 81.43701.6634	Drive Axle AIR
							4020	81.43701.6605	tag axle
22.362 (6x2) FNLL, 22.362 (6x2) UNLL		I/I	4347	81.43701.6612		O/O	40021	81.43701.6620 81.43701.6634	Drive Axle AIR
							4020	81.43701.6605	tag axle
22.362 (6x2/4) FVL		I/O	7243	81.43701.6491 81.43701.6751		I/I	4347	81.43701.6612	Drive Axle AIR
						O/O	40021	81.43701.6620	tag axle

SYMBOLS



AIR	Air Suspension	TAP	Tapered Leaf Suspension	SS	Spring Suspension	TBS	Torsion Bar Suspension
PSS	Parabolic Spring Suspension	AEON	AEON Spring	TLS	Trapezium Leaf Suspension		
MLS	Multi Leaf Suspension	RBS	Rubber Block Suspension	IFS	Independant Front Suspension		

1. Please see the Cross Reference section of this catalog for a complete list of OE references.

2. Part number marked in **Bold Italic** represent the Premium, adjustable, heavy duty gas shock absorbers.



www.meritorpartsonline.com

		FRONT				REAR			
		Mount	MERITOR	OE	REMARKS	Mount	MERITOR	OE	REMARKS



MAN

24									
24.192 FC (8x4)		O/O	77003						
24.262 (6x4) DF, 24.262 (6x4) DFL		I/O	7243	81.43701.6491 81.43701.6751		O/O	40021	81.43701.6620 81.43701.6634 81.43701.6721 81.43701.6722	AIR
24.262 (6x2) FNL		I/O	7243	81.43701.6491 81.43701.6751		O/O	40021	81.43701.6620 81.43701.6634	Drive Axle AIR
							4020	81.43701.6605	tag axle
24.262 (6x2) FNLL		I/I	4347	81.43701.6612 81.43701.6633		O/O	40021	81.43701.6620 81.43701.6634	Drive Axle AIR
							4020	81.43701.6605	tag axle
24.262 (6x2/4) FVL		I/O	7243	81.43701.6491 81.43701.6751		I/I	4347	81.43701.6612	Drive Axle AIR
						O/O	40021	81.43701.6620	tag axle
24.292 (6x4) DF, 24.292 (6x4) DFL		I/O	7243	81.43701.6491 81.43701.6751		O/O	40021	81.43701.6620 81.43701.6634 81.43701.6721 81.43701.6722	AIR
24.292 (6x2) FNL		I/O	7243	81.43701.6491 81.43701.6751		O/O	40021	81.43701.6620 81.43701.6634	Drive Axle AIR
							4020	81.43701.6605	tag axle
24.292 (6x2) FNLL		I/I	4347	81.43701.6612 81.43701.6633		O/O	40021	81.43701.6620 81.43701.6634	Drive Axle AIR
							4020	81.43701.6605	tag axle
24.292 (6x2/4) FVL		I/O	7243	81.43701.6491 81.43701.6751		I/I	4347	81.43701.6612	Drive Axle AIR
						O/O	40021	81.43701.6620	tag axle
						O/O	40021	81.43701.6620	AIR
24.302 (6x4) DFL		I/O	7243	81.43701.6491 81.43701.6751		O/O	40021	81.43701.6620 81.43701.6634 81.43701.6721 81.43701.6722	AIR
24.302 (6x2) FNL		I/O	7243	81.43701.6491 81.43701.6751		O/O	40021	81.43701.6620 81.43701.6634	Drive Axle AIR
							4020	81.43701.6605	tag axle
24.302 (6x2) FNLL		I/I	4347	81.43701.6612 81.43701.6633		O/O	40021	81.43701.6620 81.43701.6634	Drive Axle AIR
							4020	81.43701.6605	tag axle
24.302 (6x2/4) FVL		I/O	7243	81.43701.6491 81.43701.6751		I/I	4347	81.43701.6612	Drive Axle AIR
						O/O	40021	81.43701.6620	tag axle
24.332 (6x4) DF, 24.332 (6x4) DFL		I/O	7243	81.43701.6491 81.43701.6751		O/O	40021	81.43701.6620 81.43701.6634 81.43701.6721 81.43701.6722	AIR
24.332 (6x2) FNL, 24.332 (6x2) UNL		I/O	7243	81.43701.6491 81.43701.6751		O/O	40021	81.43701.6620 81.43701.6634	Drive Axle AIR
							4020	81.43701.6605	tag axle

MOUNTING DIAGRAMS

O/O	Top Eye (with sleeve) / Bottom Eye (with sleeve)	I/I	Top Pin/Stud / Bottom Pin/Stud	O/O	Top Eye / Bottom Eye
O/O	Top Eye (with sleeve) / Bottom Eye	I/O	Top Pin/Stud / Bottom Eye	O/I	Top Eye / Bottom Pin/Stud
O/I	Top Eye (with sleeve) / Bottom Pin/Stud	I/O	Top Pin/Stud / Bottom Eye (with sleeve)	O/O	Top Eye / Bottom Eye (with sleeve)

1. Please see the Cross Reference section of this catalog for a complete list of OE references.
2. Part number marked in ***Bold Italic*** represent the Premium, adjustable, heavy duty gas shock absorbers.

		FRONT				REAR			
		Mount	MERITOR	OE	REMARKS	Mount	MERITOR	OE	REMARKS

MAN

24									
24.332 (6x2) FNLL, 24.332 (6x2) UNLL		I/I	4347	81.43701.6612 81.43701.6633		O/O	40021	81.43701.6620 81.43701.6634	Drive Axle AIR
							4020	81.43701.6605	tag axle
24.332 (6x2/4) FVL		I/O	7243	81.43701.6491 81.43701.6751		I/I	4347	81.43701.6612	Drive Axle AIR
						O/O	40021	81.43701.6620	tag axle
24.362 (6x4) DF, 24.362 (6x4) DFL		I/O	7243	81.43701.6491 81.43701.6751		O/O	40021	81.43701.6620 81.43701.6634 81.43701.6721 81.43701.6722	AIR
24.362 (6x2) FNL, 24.362 (6x2) UNL		I/O	7243	81.43701.6491 81.43701.6751		O/O	40021	81.43701.6620 81.43701.6634	Drive Axle AIR
						O/O	4020	81.43701.6605	tag axle
						O/E		81.43701.6187	
24.362 (6x2) FNLL, 24.362 (6x2) UNLL		I/I	4347	81.43701.6612 81.43701.6633		O/O	40021	81.43701.6620 81.43701.6634	Drive Axle AIR
						O/O	4020	81.43701.6605	tag axle
						O/E		81.43701.6187	
24.362 (6x2/4) FVL		I/O	7243	81.43701.6491 81.43701.6751		I/I	4347	81.43701.6612	Drive Axle AIR
						O/O	40021	81.43701.6620	tag axle
24.462 (6x4) DF		I/O	7243	81.43701.6491 81.43701.6751		O/O	40133	81.43701.6594	
25									
25.192 NC		O/O	77003						
25.262 (6x4) DF, 25.262 (6x4) DFL		I/O	7243	81.43701.6491 81.43701.6751		O/O	40021	81.43701.6620 81.43701.6634 81.43701.6721 81.43701.6722	AIR
25.262 (6x2) FNL		I/O	7243	81.43701.6491 81.43701.6751		O/O	40021	81.43701.6620	Drive Axle AIR
						O/O	4020	81.43701.6605	tag axle
						O/E		81.43701.6187	
25.262 (6x2) FNLL		I/I	4347	81.43701.6612		O/O	40021	81.43701.6620	Drive Axle AIR
						O/O	4020	81.43701.6605	tag axle
						O/E		81.43701.6187	
25.262 (6x2/4) FVL		I/O	7243	81.43701.6491 81.43701.6751		I/I	4347	81.43701.6612	Drive Axle AIR
						O/O	40021	81.43701.6620	tag axle
25.280 FC, FCS		O/O	77003		Sleeper				

SYMBOLS



AIR	Air Suspension	TAP	Tapered Leaf Suspension	SS	Spring Suspension	TBS	Torsion Bar Suspension
PSS	Parabolic Spring Suspension	AEON	AEON Spring	TLS	Trapezium Leaf Suspension		
MLS	Multi Leaf Suspension	RBS	Rubber Block Suspension	IFS	Independant Front Suspension		

1. Please see the Cross Reference section of this catalog for a complete list of OE references.

2. Part number marked in **Bold Italic** represent the Premium, adjustable, heavy duty gas shock absorbers.



www.meritorpartsonline.com

		FRONT				REAR			
		Mount	MERITOR	OE	REMARKS	Mount	MERITOR	OE	REMARKS

MAN



25									
25.292 (6x4) DF, 25.292 (6x4) DFL		I/O	7243	81.43701.6491 81.43701.6751		O/O	40021	81.43701.6620 81.43701.6634 81.43701.6721 81.43701.6722	AIR
25.292 (6x2) FNL		I/O	7243	81.43701.6491		O/O	40021	81.43701.6620	Drive Axle AIR
						O/E	4020	81.43701.6605	tag axle
						O/O		81.43701.6187	
25.292 (6x2) FNLL		I/I	4347	81.43701.6612		O/O	40021	81.43701.6620	Drive Axle AIR
						O/E	4020	81.43701.6605	tag axle
						O/O		81.43701.6187	
25.320 FCS, 25.321 FC, 25.321 FCS		O/O	77003		Sleeper				
25.332 (6x4) DF, 25.332 (6x4) DFL		I/O	7243	81.43701.6491 81.43701.6751		O/O	40021	81.43701.6620 81.43701.6634	AIR
25.332 (6x2) FNL, 25.332 (6x2) UNL		I/O	7243	81.43701.6491		O/O	40021	81.43701.6620	Drive Axle AIR
						O/E		81.43701.6187	tag axle
						O/O	4020	81.43701.6605	
25.332 (6x2) FNLL, 25.332 (6x2) UNLL		I/I	4347	81.43701.6612		O/O	40021	81.43701.6620	Drive Axle AIR
						O/E		81.43701.6187	tag axle
						O/O	4020	81.43701.6605	
25.332 (6x2/4) FVL		I/O	7243	81.43701.6491 81.43701.6751		I/I	4347	81.43701.6612	Drive Axle AIR
						O/O	40021	81.43701.6620	tag axle
25.362 (6x4) DF, 25.362 (6x4) DFL		I/O	7243	81.43701.6491 81.43701.6751		O/O	40021	81.43701.6620 81.43701.6634	AIR
25.362 (6x2) FNL, 25.362 (6x2) UNL		I/O	7243	81.43701.6491		O/O	40021	81.43701.6620	Drive Axle AIR
						O/E		81.43701.6187	tag axle
						O/O	4020	81.43701.6605	
25.362 (6x2) FNLL, 25.362 (6x2) UNLL		I/I	4347	81.43701.6612		O/O	40021	81.43701.6620	Drive Axle AIR
						O/E		81.43701.6187	tag axle
						O/O	4020	81.43701.6605	
25.362 (6x2/4) FVL		I/O	7243	81.43701.6491 81.43701.6751		I/I	4347	81.43701.6612	Drive Axle AIR
						O/O	40021	81.43701.6620	tag axle

MOUNTING DIAGRAMS

O/O	Top Eye (with sleeve) / Bottom Eye (with sleeve)	I/I	Top Pin/Stud / Bottom Pin/Stud	O/O	Top Eye / Bottom Eye
O/O	Top Eye (with sleeve) / Bottom Eye	I/O	Top Pin/Stud / Bottom Eye	O/I	Top Eye / Bottom Pin/Stud
O/I	Top Eye (with sleeve) / Bottom Pin/Stud	I/O	Top Pin/Stud / Bottom Eye (with sleeve)	O/O	Top Eye / Bottom Eye (with sleeve)

1. Please see the Cross Reference section of this catalog for a complete list of OE references.
2. Part number marked in ***Bold Italic*** represent the Premium, adjustable, heavy duty gas shock absorbers.



		FRONT				REAR			
		Mount	MERITOR	OE	REMARKS	Mount	MERITOR	OE	REMARKS

MAN



26									
26.240 DF, 26.240 DFA		O/O	77003	81.43701.6535					
26.240 DH, 26.240 DHA		O/O	7188	81.43701.6426					
			M83101	81.43701.6503					
26.240 FNL	- 6/85	O/O	77003	81.43701.6348		O/E	4342	81.43701.6419	Drive Axle SS
	7/85 -	I/O	7243	81.43701.6491					tag axle
26.240 H		O/O	M83101	81.43701.6503					
26.256 DF		O/O	77003	81.43701.6535					
26.256 DH		O/O	M83101	81.43701.6503					
26.262 (6x4) DF, 26.262 (6x4) DFL		I/O	7243	81.43701.6491		O/O	40021	81.43701.6620 81.43701.6634	AIR
26.262 (4x2) (6x2) FNL, 26.262 (4x2) (6x2) UNL		I/O	7243	81.43701.6491		O/O	40021	81.43701.6620 81.43701.6634	Drive Axle AIR
						O/E		81.43701.6187	tag axle
						O/O	4020	81.43701.6605	
26.262 (4x2) (6x2) FNLL, 26.262 (4x2) (6x2) UNLL		I/I	4347	81.43701.6612 81.43701.6633		O/O	40021	81.43701.6620 81.43701.6634	Drive Axle AIR
						O/E		81.43701.6187	tag axle
						O/O	4020	81.43701.6605	
26.262 (6x2/4) FVL		I/O	7243	81.43701.6491		I/I	4347	81.43701.6612	Drive Axle AIR
						O/O	40021	81.43701.6620	tag axle
26.292 (6x4) DF, 26.292 (6x4) DFL		I/O	7243	81.43701.6491		O/O	40021	81.43701.6620	AIR
26.292 (4x2) (6x2) FNL		I/O	7243	81.43701.6491		O/O	40021	81.43701.6620 81.43701.6634	Drive Axle AIR
						O/E		81.43701.6187	tag axle
						O/O	4020	81.43701.6605	
26.292 (4x2) (6x2) FNLL		I/I	4347	81.43701.6612 81.43701.6633		O/O	40021	81.43701.6620 81.43701.6634	Drive Axle AIR
						O/E		81.43701.6187	tag axle
						O/O	4020	81.43701.6605	
26.292 (6x2/4) FVL		I/O	7243	81.43701.6491		I/I	4347	81.43701.6612	Drive Axle AIR
						O/O	40021	81.43701.6620	tag axle

SYMBOLS

AIR	Air Suspension	TAP	Tapered Leaf Suspension	SS	Spring Suspension	TBS	Torsion Bar Suspension
PSS	Parabolic Spring Suspension	AEON	AEON Spring	TLS	Trapezium Leaf Suspension		
MLS	Multi Leaf Suspension	RBS	Rubber Block Suspension	IFS	Independant Front Suspension		

1. Please see the Cross Reference section of this catalog for a complete list of OE references.
2. Part number marked in **Bold Italic** represent the Premium, adjustable, heavy duty gas shock absorbers.



		FRONT				REAR			
		Mount	MERITOR	OE	REMARKS	Mount	MERITOR	OE	REMARKS



MAN

26									
26.320 DF, 26.320 DFA, 26.320 DFU		O/O	77003	81.43701.6535					
26.332 (6x4) DF, 26.332 (6x4) DFL		I/O	7243	81.43701.6491		O/O	40021	81.43701.6620 81.43701.6634	AIR
26.332 (4x2) (6x2) FNL, 26.332 (4x2) (6x2) UNL		I/O	7243	81.43701.6491 81.43701.6699		O/O	40021	81.43701.6620 81.43701.6634	Drive Axle AIR
						O/E		81.43701.6187	tag axle
						O/O	4020	81.43701.6605	
26.332 (4x2) (6x2) FNLL, 26.332 (4x2) (6x2) UNLL		I/I	4347	81.43701.6612		O/O	40021	81.43701.6620 81.43701.6634	Drive Axle AIR
						O/E		81.43701.6187	tag axle
						O/O	4020	81.43701.6605	
26.332 (6x2/4) FVL		I/O	7243	81.43701.6491		I/I	4347	81.43701.6612	Drive Axle AIR
						O/O	40021	81.43701.6620	tag axle
26.362 (6x4) DF, DFL		I/O	7243	81.43701.6491		O/O	40021	81.43701.6620 81.43701.6634	AIR
26.362 (4x2) (6x2) FNL, 26.362 (4x2) (6x2) UNL		I/O	7243	81.43701.6491 81.43701.6699 81.43701.6794		O/O	40021	81.43701.6620 81.43701.6634	Drive Axle AIR
						O/E		81.43701.6187	tag axle
						O/O	4020	81.43701.6605	
26.362 (4x2) (6x2) FNLL, 26.362 (4x2) (6x2) UNLL		I/I	4347	81.43701.6612		O/O	40021	81.43701.6620 81.43701.6634	Drive Axle AIR
						O/E		81.43701.6187	tag axle
						O/O	4020	81.43701.6605	tag axle
26.362 (6x2/4) FVL		I/O	7243	81.43701.6491 81.43701.6794		I/I	4347	81.43701.6612	Drive Axle AIR
						O/O	40021	81.43701.6620	tag axle
26.400		I/O	7243	81.43701.6491 81.43701.6699		I/O	40133	81.43701.6594	
26.402 (6x4)	92-	I/O	7243	81.43701.6491		I/O	40133	81.43701.6594 81.43701.6595	SS
						O/O	40021	81.43701.6721	AIR
26.402 (6x6)		I/O	7243	81.43701.6491		O/O	40021	81.43701.6721	
26.402 (6x4) (6x6) FC, 26.402 (6x4) (6x6) FCS	97-	I/O	7243	81.43701.6793					
26.403 (6x2) (F2000) FNL		I/O	7243	81.43701.6793		O/O	40021	81.43701.6620 81.43701.6634 81.43701.6827	Drive Axle AIR
						O/E		81.43701.6187	tag axle
						O/O	4020	81.43701.6605	
26.403 (6x2) (F2000) FNLL		I/I	4347	81.43701.6612		O/O	40021	81.43701.6620 81.43701.6634 81.43701.6827	Drive Axle AIR
						O/E		81.43701.6187	tag axle
						O/O	4020	81.43701.6605	

MOUNTING DIAGRAMS

O/O	Top Eye (with sleeve) / Bottom Eye (with sleeve)	I/I	Top Pin/Stud / Bottom Pin/Stud	O/O	Top Eye / Bottom Eye
O/O	Top Eye (with sleeve) / Bottom Eye	I/O	Top Pin/Stud / Bottom Eye	O/I	Top Eye / Bottom Pin/Stud
O/I	Top Eye (with sleeve) / Bottom Pin/Stud	I/O	Top Pin/Stud / Bottom Eye (with sleeve)	O/O	Top Eye / Bottom Eye (with sleeve)

1. Please see the Cross Reference section of this catalog for a complete list of OE references.
2. Part number marked in ***Bold Italic*** represent the Premium, adjustable, heavy duty gas shock absorbers.

		FRONT				REAR			
		Mount	MERITOR	OE	REMARKS	Mount	MERITOR	OE	REMARKS

MAN



26									
26.403 (6x2/4) FVL (F2000)		I/O	7243	81.43701.6491 81.43701.6794		I/I	4347	81.43701.6612	Drive Axle AIR
						O/O	40021	81.43701.6620	tag axle
26.460 BLS		I/O		81.43701.6964					
26.463 (6x4) FCLS	97-	I/O	2566	82.43701.6017					
26.464 (6x4)						O/O	40021	81.43701.6827	AIR
26.464 (6x6) DFARC (F2000)		I/O	7243	81.43701.6699		I/O	40133	81.43701.6594	SS
26.482	95-	I/O	7243	81.43701.6794		I/O	40133	81.43701.6594	SS
28									
28.372 (8x4) T / VF	90-	I/O	7243	81.43701.6491 81.43701.6699		O/O	40021		
30									
30.240 DF		O/O	M83101 77003	81.43701.6503 81.43701.6635					
30.240 DH, 30.240 DHR		O/O	M83101	81.43701.6503					
30.256 DF		O/O	77003	81.43701.6635					
30.256 DH		O/O	M83101	81.43701.6503					
30.280 DH 30.320 DH	74-84	O/O	M83101	81.43701.6503					
30.362 (8x4) FCTS	-96	I/O	7243	81.43701.6695					
30.400 (8x4) FCTS	-96	I/O	7243	81.43701.6695					
30.402 (8x4) FCTS	-96	I/O	7243	81.43701.6695					
30.422 (8x4) NZ	94-97	I/O	7243						
32									
32.240 DF		O/O	77003	81.43701.6635					
32.240 DFH, 32.240 DH, 32.240 DHR		O/O	M83101	81.43701.6503					
32.240 DHA		O/O	7188	81.43701.6426					
32.403 (8x4) FCTS	97-	I/O	7243	81.43701.6699		I/O	40133	81.43701.6594	
32.462 (6X6) DF, 32.462 (6X6) DFA		I/O	7243	81.43701.6491		I/I	4347	81.43701.6492	SS
32.462 (6X6) F, 32.462 (6X6) FL		I/O	7243	81.43701.6491		O/O	40021	81.43701.6620	AIR
32.462 (6X6) FLL		I/I	4347	81.43701.6612					
32.463 (8x4)	97-	I/O	7243	81.43701.6793					

SYMBOLS

AIR	Air Suspension	TAP	Tapered Leaf Suspension	SS	Spring Suspension	TBS	Torsion Bar Suspension
PSS	Parabolic Spring Suspension	AEON	AEON Spring	TLS	Trapezium Leaf Suspension		
MLS	Multi Leaf Suspension	RBS	Rubber Block Suspension	IFS	Independant Front Suspension		

1. Please see the Cross Reference section of this catalog for a complete list of OE references.
2. Part number marked in **Bold Italic** represent the Premium, adjustable, heavy duty gas shock absorbers.





		FRONT				REAR			
		Mount	MERITOR	OE	REMARKS	Mount	MERITOR	OE	REMARKS

MAN									
33									
33.362 DF		I/O	7243	81.43701.6491 81.43701.6699					
33.362 T (8x4) VF		I/O	7243	81.43701.6491 81.43701.6699					
33.422		I/O	7243	81.43701.6491 81.43701.6699					
33.422 T (8x4) VF		I/O	7243	81.43701.6491 81.43701.6699					
33.462 (6x6) DF, 33.462 (6x6) DFA		I/O	7243	81.43701.6491		I/I	4347	81.43701.6492	SS
						O/O	40021	81.43701.6620	AIR
33.462 (6x6) F, 33.462 (6x6) FL		I/O	7243	81.43701.6491		I/I	4347	81.43701.6492	SS
						O/O	40021	81.43701.6620	AIR
33.462 (6x6) FLL		I/I	4347	81.43701.6612		I/I	4347	81.43701.6492	SS
						O/O	40021	81.43701.6620	AIR
35									
35.403 (8x8)	97-	I/O	7243	81.43701.6793		I/O	40133	81.43701.6594	SS
36									
36.402		I/O	7243	81.43701.6699 81.43701.6793					
38									
38.462 DF		I/O	7243	81.43701.6491		I/I	4347	81.43701.6492	SS
						O/O	40021	81.43701.6620	AIR
38.462 F, 38.462 FL		I/O	7243	81.43701.6491		I/I	4347	81.43701.6492	SS
						O/O	40021	81.43701.6620	AIR
38.462 FLL		I/I	4347	81.43701.6612		I/I	4347	81.43701.6492	SS
						O/O	40021	81.43701.6620	AIR
40									
40.222 (NZ)		I/O	7243	81.43701.6491		I/I	4347	81.43701.6492	SS
						O/O	40021	81.43701.6620	AIR
40.462 DF		I/O	7243	81.43701.6491		I/I	4347	81.43701.6492	SS
						O/O	40021	81.43701.6620	AIR
40.462 F, 40.462 FL		I/O	7243	81.43701.6491		I/I	4347	81.43701.6492	SS
						O/O	40021	81.43701.6620	AIR
40.462 FLL		I/I	4347	81.43701.6612		I/I	4347	81.43701.6492	SS
						O/O	40021	81.43701.6620	AIR

MOUNTING DIAGRAMS					
O/O	Top Eye (with sleeve) / Bottom Eye (with sleeve)	I/I	Top Pin/Stud / Bottom Pin/Stud	O/O	Top Eye / Bottom Eye
O/O	Top Eye (with sleeve) / Bottom Eye	I/O	Top Pin/Stud / Bottom Eye	O/I	Top Eye / Bottom Pin/Stud
O/I	Top Eye (with sleeve) / Bottom Pin/Stud	I/O	Top Pin/Stud / Bottom Eye (with sleeve)	O/O	Top Eye / Bottom Eye (with sleeve)

1. Please see the Cross Reference section of this catalog for a complete list of OE references.
2. Part number marked in ***Bold Italic*** represent the Premium, adjustable, heavy duty gas shock absorbers.

		FRONT				REAR			
		Mount	MERITOR	OE	REMARKS	Mount	MERITOR	OE	REMARKS

MAN

41									
41.462 DF		I/O	7243	81.43701.6491		I/I	4347	81.43701.6492	SS
						O/O	40021	81.43701.6620	AIR
41.462 F, 41.462 FL		I/O	7243	81.43701.6491		I/I	4347	81.43701.6492	SS
						O/O	40021	81.43701.6620	AIR
41.462 FLL		I/I	4347	81.43701.6612		I/I	4347	81.43701.6492	SS
						O/O	40021	81.43701.6620	AIR
41.463 (NZ)	98	I/O	7243	81.43701.6491					
41.502 F, 41.502 FL		I/O	7243	81.43701.6491		I/I	4347	81.43701.6492	SS
						O/O	40021	81.43701.6620	AIR
41.502 FLL		I/I	4347	81.43701.6612		I/I	4347	81.43701.6492	SS
						O/O	40021	81.43701.6620	AIR

48

48.462 DF		I/O	7243	81.43701.6491		I/I	4347	81.43701.6492	SS
						O/O	40021	81.43701.6620	AIR
48.462 F, 48.462 FL		I/O	7243	81.43701.6491		I/I	4347	81.43701.6492	SS
						O/O	40021	81.43701.6620	AIR
48.462 FLL		I/I	4347	81.43701.6612		I/I	4347	81.43701.6492	SS
						O/O	40021	81.43701.6620	AIR

MAN NZ

F54 (8x4), F55 (6x4)		I/O	7243						
----------------------	--	-----	------	--	--	--	--	--	--

MAZDA

T									
T2000, T2600, T3000, T3500, T4000, T4100, T4600		I/O	M63211	W023-34-710 W023-99-341		O/O	M63299	W023-28-700 W023-99-281 W723-28-700 W723-99-281	

MERCEDES

9									
911 L, 911 LK, 911 LP		O/O	76039	000 323 9700					
911B L, 911B LF, 911B LK, 911B LKO, 911B LS	61-	O/O	76019	004 323 7400		O/O	76022 76104	001 326 6500 345 326 7500	
911B LA, 911B LAK, 911B LAKO (355 102 CH)	61-	O/O	2444	004 323 6200		O/O	76104	001 326 3300 345 326 7500	

SYMBOLS



AIR	Air Suspension	TAP	Tapered Leaf Suspension	SS	Spring Suspension	TBS	Torsion Bar Suspension
PSS	Parabolic Spring Suspension	AEON	AEON Spring	TLS	Trapezium Leaf Suspension		
MLS	Multi Leaf Suspension	RBS	Rubber Block Suspension	IFS	Independant Front Suspension		

1. Please see the Cross Reference section of this catalog for a complete list of OE references.

2. Part number marked in **Bold Italic** represent the Premium, adjustable, heavy duty gas shock absorbers.





www.meritorpartsonline.com

		FRONT				REAR			
		Mount	MERITOR	OE	REMARKS	Mount	MERITOR	OE	REMARKS

MERCEDES									
12 (also refer Mercedes Atego)									
1217, 1217K (387 017 CH)		O/O	2444	004 323 6500		I/O	4065	385 326 0100	
1217 (381 051 CH)		O/O	2444	004 323 5500		I/O	40133	381 326 0200	Chassis 4306945 ~
1224F (650 086)		O/O	2444	003 323 8900					
14									
1413 (383 CH)		O/O	2444	004 323 6400		I/O	40133	381 326 0200	
1413 K, 1413 L, 1413 LK, 1413 LS		O/O	76038						
1417 (616 017)		O/O	2444	004 323 6400		I/O	4065	385 326 0100	
1417 (616 017 CH)		O/O	2444	003 323 8800 004 323 6400		I/O	40133	617 326 0000	
1417 K		O/O	76038						
1418LS		O/O	76039	000 323 9700					
1418LP (354 054)		O/O	7252	001 323 3900 004 323 3300 004 323 7100		O/O	76104	001 326 6600	AIR
						I/I	2508	003 326 7500	
1419 (383 CH) (383 027)		O/O	2444	004 323 6400					
1419 (385 054) (383 055)		O/O	2444	004 323 5500		I/O	4065	385 326 0100	Chassis ~ 4306944
						I/O	40133	381 326 0200	Chassis 4306945 ~
1419LP		I/O	2566	004 323 8800					
1419LP (352 CH)		O/O	2444	004 323 6400	Chassis ~ 600382	O/O	76022	001 326 6500	352 055
							I/O	2566	352 323 0000
1422 (616 064 CH)		O/O	2444	003 323 2000 003 323 8900 003 323 6400				003 326 9300 381 326 0300	
1422 (616 121, 616 131, 616 132)		O/O	2444	004 323 5500 003 323 6400		I/O	4065	385 326 0100	
						O/O	76104	004 326 0100	
1424 (383 056) (383 057)		O/O	2444	004 323 5500		I/O	4065	385 326 0200	Chassis ~ 4306944
							40133	381 326 0200	Chassis 4306945 ~
1425 (616 122, 616 131, 616 132)		O/O	2444	004 323 5500		O/O	76104	004 326 0100	
15 (also refer Mercedes Atego)									
1517L (B)		O/O		384 323 7000		O/O		384 326 7000	

MOUNTING DIAGRAMS					
O/O	Top Eye (with sleeve) / Bottom Eye (with sleeve)	I/I	Top Pin/Stud / Bottom Pin/Stud	O/O	Top Eye / Bottom Eye
O/O	Top Eye (with sleeve) / Bottom Eye	I/O	Top Pin/Stud / Bottom Eye	O/I	Top Eye / Bottom Pin/Stud
O/I	Top Eye (with sleeve) / Bottom Pin/Stud	I/O	Top Pin/Stud / Bottom Eye (with sleeve)	O/O	Top Eye / Bottom Eye (with sleeve)

1. Please see the Cross Reference section of this catalog for a complete list of OE references.
2. Part number marked in ***Bold Italic*** represent the Premium, adjustable, heavy duty gas shock absorbers.

		FRONT				REAR			
		Mount	MERITOR	OE	REMARKS	Mount	MERITOR	OE	REMARKS

MERCEDES

16 (also refer Mercedes Atego)

1617 (NZ)		○/○	2444						
1625		○/○	2444	004 323 6400		I/○	4065	385 326 0100	
1626 (387 012), 1626 (387 044)		○/○	2444	004 323 4500 006 323 0700		I/I	2215	391 326 0100	

17

1719 (387 002), 1719 (387 034)		○/○	2444	004 323 4500 004 323 6200 004 323 0700		I/I	2215	002 326 1100 002 326 2900	
1733 (NZ)	91	○/○	2444			I/○	4065		
1734		○/○	2444	003 323 6600		I/○	M85319 M89428	681 326 0400 16-13947-000	AIR

18 (also refer Mercedes Actross)

1831 (L)		○/○	2444	003 323 6600 004 323 6700		○/○	77003	004 326 7000	
1834		○/○	2444	003 323 6600		I/○	40133	617 326 0000	

19

1923		○/○	76019	001 323 7800					
1924 L, 1924 LA, 1924 LK		○/○	76019	004 323 6100					
			2444	004 323 4400 004 323 4500 004 323 4900					
1924 LS, 1924 LAS		○/○	2444	004 323 4900					
1924 LP		○/○	7252	001 323 3900					
1926 S (389)		○/○	2180	004 323 4500		I/I	2215	391 326 0100	
1928 LS		○/○	2444	006 323 0700 006 323 0800 006 323 0900		○/○	M83101	002 326 5500 005 326 2000	

22

2219 (385 CH), 2219 (619 CH), 2222 (619 CH)		○/○	2444	003 323 1900 004 323 6400 004 323 6600					○/○	4362	002 326 3400	Chassis ~ 4 450302 (393 311 CH) ~ 4 453073 (393 321 CH)
										M83101	002 326 5500	
									○/○	40073	003 326 8000	Chassis 4 450302 (393 311 CH) ~ 4 473074 (393 12 CH) ~
										M83101	005 326 2000	
									4362	002 326 9200	Chassis 4 496613 ~	



SYMBOLS

AIR	Air Suspension	TAP	Tapered Leaf Suspension	SS	Spring Suspension	TBS	Torsion Bar Suspension
PSS	Parabolic Spring Suspension	AEON	AEON Spring	TLS	Trapezium Leaf Suspension		
MLS	Multi Leaf Suspension	RBS	Rubber Block Suspension	IFS	Independant Front Suspension		

1. Please see the Cross Reference section of this catalog for a complete list of OE references.

2. Part number marked in **Bold Italic** represent the Premium, adjustable, heavy duty gas shock absorbers.



		FRONT				REAR			
		Mount	MERITOR	OE	REMARKS	Mount	MERITOR	OE	REMARKS

MERCEDES



22									
2224 (361 CH), 2224 (385 CH)	O/O	7252	002 323 1800 004 323 7100		O/O	4362	002 326 3400	Chassis ~ 4 450302 (393 311 CH) ~ 4 453073 (393 321 CH)	
						M83101	002 326 5500		
						40073	003 326 8000		
2225 (619 CH)	O/O	2444	004 323 6400		O/O	4362	002 326 3400	Chassis ~ 4 450302 (393 311 CH) ~ 4 453073 (393 321 CH)	
						M83101	002 326 5500		
						40073	003 326 8000		
2226, 2232	O/O	2444	004 323 4500 004 323 4600 005 323 4100 006 323 0900		O/O	4362	002 326 3400	Chassis ~ 4 450302 (393 311 CH) ~ 4 453073 (393 321 CH)	
						M83101	002 326 5500		
						40073	003 326 8000		
2233 (NZ) (8x4)	O/O	2444			O/O	4362		Chassis 4 450302 (393 311 CH) ~ 4 473074 (393 12 CH) ~	
						M83101	005 326 2000		
						4362	002 326 9200		
2235, 2236, 2238	O/O	2444	005 323 4100 006 323 0900		O/O	M83101	002 326 5500		
2244	O/O	2444	004 323 4600 006 323 0800		O/O	4362	002 326 9200		

MOUNTING DIAGRAMS

O/O	Top Eye (with sleeve) / Bottom Eye (with sleeve)	I/I	Top Pin/Stud / Bottom Pin/Stud	O/O	Top Eye / Bottom Eye
O/O	Top Eye (with sleeve) / Bottom Eye	I/O	Top Pin/Stud / Bottom Eye	O/I	Top Eye / Bottom Pin/Stud
O/I	Top Eye (with sleeve) / Bottom Pin/Stud	I/O	Top Pin/Stud / Bottom Eye (with sleeve)	O/O	Top Eye / Bottom Eye (with sleeve)

1. Please see the Cross Reference section of this catalog for a complete list of OE references.
2. Part number marked in ***Bold Italic*** represent the Premium, adjustable, heavy duty gas shock absorbers.



		FRONT				REAR			
		Mount	MERITOR	OE	REMARKS	Mount	MERITOR	OE	REMARKS

MERCEDES

24 (also refer Mercedes Atego)

2433 (652 CH)		○/○	2444	003 323 6600 004 323 6700		I/○	40133	617 326 0000	
2434	92	○/○	2444	004 323 6400		I/○	M85319 M89428	681 326 0400 16-13947-000	AIR
2435 L, 2435 LS	93	○/○	2444	005 323 4100 006 323 0900		○/○	M83101	002 326 5500	
2448	92	○/○	2444	004 323 4600		○/○	4362	002 326 9200	

25

2534	93-	○/○	2444	004 323 6400 004 323 6600 005 323 6800		I/○	M85319 M89428	681 326 0400 16-13947-000	AIR
2550	93-	○/○	2444	004 323 4600 005 323 4100		○/○	4362	002 326 9200	
2553 (NZ)		○/○	2444	006 323 0800		○/○	4362		

26 (also refer Mercedes Actross)

2624 LA		○/○	7188	001 323 7900 004 323 6000					
2628 (624 333)		○/○	2444	006 323 0700					
2632 (395 CH)		○/○	2444	004 323 4500 006 323 0700					
2648, 2650		○/○	2444	004 323 4500 004 323 5500 006 323 0700					

28

2822 Twin Steer	86-	○/○	2444	004 323 6400					
-----------------	-----	-----	------	--------------	--	--	--	--	--

30

3034 Twin Steer	95-					○/○	M85060	665174	Chalmers 854 RBS
-----------------	-----	--	--	--	--	-----	--------	--------	----------------------------

32 (also refer Mercedes Actross)

3228 Twin Steer		○/○	2444	006 323 0900	1st Axle				
				005 323 4100	2nd Axle				

38

3836		○/○	4362						
------	--	-----	------	--	--	--	--	--	--

SYMBOLS



AIR	Air Suspension	TAP	Tapered Leaf Suspension	SS	Spring Suspension	TBS	Torsion Bar Suspension
PSS	Parabolic Spring Suspension	AEON	AEON Spring	TLS	Trapezium Leaf Suspension		
MLS	Multi Leaf Suspension	RBS	Rubber Block Suspension	IFS	Independant Front Suspension		

1. Please see the Cross Reference section of this catalog for a complete list of OE references.

2. Part number marked in **Bold Italic** represent the Premium, adjustable, heavy duty gas shock absorbers.



www.meritorpartsonline.com

		FRONT				REAR			
		Mount	MERITOR	OE	REMARKS	Mount	MERITOR	OE	REMARKS

MERCEDES (ACTROSS)

18 (4x2)

1836, 1840, 1841, 1844	O/O	2444	005 323 9500 006 323 7800		O/O	006 326 1200	2 Bag AIR
		2004	005 323 9100 005 323 9700 006 323 1600 006 323 5100 006 323 7200 006 323 7900				
		2775	006 323 3300 006 323 3900				
		2597	005 323 9900 006 323 6300				



26 (6x4)

2632, 2636, K33, LS33, S33, L48	O/O	2004	005 323 9100 005 323 9700 006 323 1600 006 323 5100 006 323 7200 006 323 7900		O/O	40154	005 326 0900 005 326 5700	8 Bag AIR
		2775	006 323 3300 006 323 3900			4421	005 326 1200 005 326 6800	
2640, 2641, 2643, 2644, 2648, 2650, K33, LS33, S33, L48	O/O	2444	005 323 9600 006 323 5400 006 323 7800		O/O	40154	005 326 0900 005 326 5700	8 Bag AIR
		2004	005 323 9100 005 323 9700 006 323 1600 006 323 5100 006 323 7200 006 323 7900					
		2775	006 323 3300 006 323 3900			4421	005 326 1200 005 326 6800	
		2597	005 323 9900			AIR		
2653 LS	O/O	2444	004 323 4400 004 323 4500 004 323 9500		O/O	40154	005 326 0900 005 326 5700	8 Bag AIR
						4421	005 326 1200 005 326 6800	
2654 LS/33	O/O	2444	005 323 9600 006 323 5400		O/O	40154	005 326 0900 005 326 5700	8 Bag AIR
		2004	005 323 9100 005 323 9700 006 323 1600 006 323 5100 006 323 7200 006 323 7900					
		2775	006 323 3300 006 323 3900			4421	005 326 1200 005 326 6800	

MOUNTING DIAGRAMS

O/O	Top Eye (with sleeve) / Bottom Eye (with sleeve)	I/I	Top Pin/Stud / Bottom Pin/Stud	O/O	Top Eye / Bottom Eye
O/O	Top Eye (with sleeve) / Bottom Eye	I/O	Top Pin/Stud / Bottom Eye	O/I	Top Eye / Bottom Pin/Stud
O/I	Top Eye (with sleeve) / Bottom Pin/Stud	I/O	Top Pin/Stud / Bottom Eye (with sleeve)	O/O	Top Eye / Bottom Eye (with sleeve)

1. Please see the Cross Reference section of this catalog for a complete list of OE references.
2. Part number marked in ***Bold Italic*** represent the Premium, adjustable, heavy duty gas shock absorbers.

		FRONT				REAR			
		Mount	MERITOR	OE	REMARKS	Mount	MERITOR	OE	REMARKS

MERCEDES (ACTROSS)

32 (8x4)

3232, 3236		O/O	2444	005 323 4000 005 323 4100 005 323 9600					
3240, 3240L		O/O	2444	005 323 4000 005 323 4100 005 323 9600		O/O	40154	005 326 0900 005 326 5700	8 Bag AIR
3241, 3241L		O/O	2444	005 323 4100 005 323 9600					
3243, 3243L		O/O	2444	005 323 9600		O/O	40154	005 326 0900 005 326 5700	8 Bag AIR
3244, 3244L		O/O	2444	005 323 4100 005 323 9600					
3246		O/O	2444	005 323 4000					
3248, 3248L		O/O	2444	005 323 4100 005 323 9600					

33 (6x4)

3353 (6x4)		O/O	2444	005 323 9500					
			2015	005 323 9100					

39

3939		O/O		006 323 4500		O/O	40154	005 326 6000 005 326 6400	
------	--	-----	--	--------------	--	-----	-------	------------------------------	--

MERCEDES (ATEGO)

12 (4x2)

1223 L, 1224 L, 1228 L, 1229 L		O/O	7300	974 323 0000 974 323 0400 974 323 0600 974 323 1100		O/O	40127	974 326 0100	2 Bag AIR
-----------------------------------	--	-----	------	--	--	-----	-------	--------------	------------------

15 (4x2)

1528 LS36 (4x2)		O/O	7300	974 323 0600 974 323 1100		O/O	40127	974 326 0100	2 Bag AIR
-----------------	--	-----	------	------------------------------	--	-----	-------	--------------	------------------

16 (4x2)

1623 L, 1624 L, 1628 L, 1628 AF, 1629 L, 1629 LF, 1629 A		O/O	7300	974 323 0600 974 323 1100		O/O	40127	974 326 0100	2 Bag AIR
--	--	-----	------	------------------------------	--	-----	-------	--------------	------------------

MITSUBISHI

FB

FB080 (NZ)		I/O	M63320						
FB091A (NZ), FB092A (NZ), FB029B (NZ)		I/O	M63320			O/O		MC114590	
FB458 (NZ)		I/O	76103						
FB511		I/O		MC110492		O/O		MC114590	

SYMBOLS



AIR	Air Suspension	TAP	Tapered Leaf Suspension	SS	Spring Suspension	TBS	Torsion Bar Suspension
PSS	Parabolic Spring Suspension	AEON	AEON Spring	TLS	Trapezium Leaf Suspension		
MLS	Multi Leaf Suspension	RBS	Rubber Block Suspension	IFS	Independant Front Suspension		

1. Please see the Cross Reference section of this catalog for a complete list of OE references.

2. Part number marked in **Bold Italic** represent the Premium, adjustable, heavy duty gas shock absorbers.



www.meritorpartsonline.com

		FRONT				REAR			
		Mount	MERITOR	OE	REMARKS	Mount	MERITOR	OE	REMARKS

MITSUBISHI

FC

FC211, FC212	79-	I/O	M63320	MB025127 MB025382		O/O	M63178	MB161497	
FC339	90-	I/O	M63320			O/O	M63178	MB161497	
FC432	90-	I/O	M63320	MB025382		O/O	M63178	MB161497	

FE (inc. Canter)



FE83P	05-	I/O		MC110491 MC110495		O/O	M63299	MC096225	
FE84P (MWB)	05-	I/O		MC110495	PSS	O/O	M63299	MC096225	
FE84P (LWB & TIPPER)	05-	I/O		MC110495	MLS	O/O	M63299	MC096225	
FE85P	05-	I/O		MC110495		O/O	M63299	MC096225	
FE090 (NZ), FE091, FE110	94-	I/O	M63320			O/O	M63299		
FE111, FE114, FE134	10/82- 10/85	I/O	M63320	MB025383		O/O	M63299	MB161555	
FE155 (NZ)	02-	I/O		MC110491					
FE122F (NZ), FE126F (NZ)	2001	I/O	M63320			O/O	M63299		
FE211, FE214, FE234	11/78- 85	I/O	M63320	MB025127 MB025382 MB025384		O/O	M63299 M63178	MB161555 MB161497	
FE325 (NZ)		I/O	M63320	MB025381		O/O	M63178	MB161497	
FE334	90-95	I/O	M63320	MB025381		O/O	M63178	MB161497	
FE339, FE431, FE434, FE435, FE437, FE439	10/85-94	I/O	M63320	MB025381 MB025127 MB025382 MB025384		O/O	M63178	MB161497	
FE439	94-	I/O		MC110491					
FE444, FE445, FE447	10/85-	I/O	M63320	MB025382 MB025384		O/O	M63178	MB161497	
FE516 (NZ)	96	I/O	M63320						
FE517 (NZ)		I/O				O/O		MC114590	
FE534	02-	I/O		MC110491					
FE537, FE539	95-02	I/O		MC110491					
FE635 (NZ)		I/O		MC110491		O/O	M63178		
FE637, FE639	96-	I/O		MC110491		O/O	M63178	MC114595	
FE647, FE649, FE657, FE659	95-	I/O		MC110491		O/O	M63299	MC096225	
FES116 (NZ)		I/O	M63320			O/O	M63299		

MOUNTING DIAGRAMS

O/O	Top Eye (with sleeve) / Bottom Eye (with sleeve)	I/I	Top Pin/Stud / Bottom Pin/Stud	O/O	Top Eye / Bottom Eye
O/O	Top Eye (with sleeve) / Bottom Eye	I/O	Top Pin/Stud / Bottom Eye	O/I	Top Eye / Bottom Pin/Stud
O/I	Top Eye (with sleeve) / Bottom Pin/Stud	I/O	Top Pin/Stud / Bottom Eye (with sleeve)	O/O	Top Eye / Bottom Eye (with sleeve)

1. Please see the Cross Reference section of this catalog for a complete list of OE references.
2. Part number marked in **Italic** represent the Premium, adjustable, heavy duty gas shock absorbers.



		FRONT				REAR			
		Mount	MERITOR	OE	REMARKS	Mount	MERITOR	OE	REMARKS

mitsubishi

FG (4x4)

FG63E (4x4) (NZ)						O/O	M63178		
FG145 (4x4) (NZ)	07-					O/O	M63178		
FG325 (NZ), FG327 (NZ)		I/O		MB294428					
FG337		I/O	M63320			O/O	M63178	MB161741	
FG434, FG439	89-97	I/O	M63320	MB025382 MC826268		O/O	M63178	MB161741	
FG637, FG639	95-98	I/O		MB294428 MB294429	12mm lower mount pin	O/O	M63178	MB161741 MC114594 MC114595	
			M63320	MB025382 MC826268	16mm lower mount pin				
FG649	03-	I/O		MB294428 MB294429		O/O	M63178	MC114595	
FG84D	08-	I/O		MB294428 MB294429		O/O	M63178	MC114595	

FH

FH100	88-	I/O	M63320	MC570680		I/I	56105	MC809390	
FH215		I/O	M63320	MC092215					
FH218 (NZ)	96-	I/O	M63320	MC826268					

FK (inc. Fighter 5.0 / 6.0 / 7.0)

FK102, FK103, FK115, FK116	7/76- 84	I/O	M63320	MC816100 MC816202					
FK161 (NZ), FK163 (NZ)	95-	I/O	M63211						
FK190(NZ)		I/O	M63448	MC814614					
FK195H (NZ), FK196H (NZ)		I/O	M63320						
FK315, FK316, FK325	2/86- 10/86	I/I	56105	MC809389					
	11/86-	I/O	M63320	MC802624					
		I/I	56105	MC809389					
FK330, FK335, FK337	10/88-	I/O	M63320	MC802624		I/I	76034	MC805986	
FK335 (NZ)	93-	I/O	M63320						
FK412J (NZ)	88	I/O	M63320						
FK415	85-92	I/I	56105	MC809389 MC813511	Note: Before replacing, check OE number				
		I/I	M83318	MC813135 MC819779					
		I/O	M63320	MC826136					
		I/O	M63320	MC802624					
		I/O	M63448	MC091947					
		I/O	M63448	MC814614					

SYMBOLS



AIR	Air Suspension	TAP	Tapered Leaf Suspension	SS	Spring Suspension	TBS	Torsion Bar Suspension
PSS	Parabolic Spring Suspension	AEON	AEON Spring	TLS	Trapezium Leaf Suspension		
MLS	Multi Leaf Suspension	RBS	Rubber Block Suspension	IFS	Independant Front Suspension		

1. Please see the Cross Reference section of this catalog for a complete list of OE references.

2. Part number marked in **Bold Italic** represent the Premium, adjustable, heavy duty gas shock absorbers.



www.meritorpartsonline.com

		FRONT				REAR			
		Mount	MERITOR	OE	REMARKS	Mount	MERITOR	OE	REMARKS

MITSUBISHI

FK (inc. Fighter 5.0 / 6.0 / 7.0)

FK416	2/84-9/87	I/I	56105	MC809389					
FK416, K416M (NZ), K417, FK417K, FK417M (NZ)	10/87-	I/O	M63320	MC826136 MC802624		I/I	76034	MC805986	
FK455	91-	I/O	M63448	MC814614					
FK457	89-95	I/O	M63448	MC091947 MC814614					
FK515, FK516, FK517	10/87-	I/O	M63320	MC802624		I/I	76034	MC805986	
FK600	-95	I/O	M63320	MC826136					
FK616 (NZ)		I/O	M63320						
FK617	95-98	I/O	M63320	MC093586 MC826136					
FK617 (Fighter 5.0 & 6.0)	02-	I/O	M63320	MC093586					
FK618	95-98	I/O	M63320	MC826136					
FK618 (Fighter)	95-03	I/O	M63320	MC093586					
FK61F (Fighter 6.0 & 7.0)	03-	I/O	M63320	MC093586					

FM (inc. Fighter 8.0 / 10.0)



FM196J (NZ)	97	I/O	M63448	MC091947					
FM215	76-85	I/O	M63320	MC816100					
FM220 (NZ), FM225 (NZ)	93	I/O	M63320			O/O	M85308 M89422		
FM515	85-	I/I	M83318	MC819780					
FM517	91-95	I/O	M63448 M85311	MC814614 MC091948 MC628804	19mm lower mounting pin 22mm lower mounting pin				
FM555	10/85-5/88	I/I	M83318	MC813135 MC819780		O/O	M63178	MB161497	
	88-91	I/O	M63448	MC814614 MC091947		O/O	M63178	MB161497	
FM557	85-95	I/O	M63448 M85311	MC814614 MC091948 MC628804	19mm lower mounting pin 22mm lower mounting pin				
FM600, FM617		I/O	M63322						
FM618 (Fighter), FM657 (Fighter), FM658 (Fighter)	95-02	I/O	M63448 M85311	MC091947 MC091948	19mm lower mounting pin 22mm lower mounting pin				

MOUNTING DIAGRAMS

O/O	Top Eye (with sleeve) / Bottom Eye (with sleeve)	I/I	Top Pin/Stud / Bottom Pin/Stud	O/O	Top Eye / Bottom Eye
O/O	Top Eye (with sleeve) / Bottom Eye	I/O	Top Pin/Stud / Bottom Eye	O/I	Top Eye / Bottom Pin/Stud
O/I	Top Eye (with sleeve) / Bottom Pin/Stud	I/O	Top Pin/Stud / Bottom Eye (with sleeve)	O/O	Top Eye / Bottom Eye (with sleeve)

1. Please see the Cross Reference section of this catalog for a complete list of OE references.
2. Part number marked in **Bold Italic** represent the Premium, adjustable, heavy duty gas shock absorbers.



		FRONT				REAR			
		Mount	MERITOR	OE	REMARKS	Mount	MERITOR	OE	REMARKS

MITSUBISHI

FM (inc. Fighter 8.0 / 10.0)

FM677 (Fighter)	97-02	I/O	M85311	MC091948					
FM61F (Fighter 8.0)	02-08	I/O	M85311	MC091948					
FM65F (Fighter 10.0)	03-08	I/O	M85311	MC091948					
FM67 (Fighter 10.0)	03-08	I/O	M85311	MC091948		O/O	M85013	57905-001 60670-005	Hendrickson HAS AIR

FN (Fighter 14.0)

FN61F, FN62F (6x2) (6x4)	02-08	I/O	M85311	MC091948					6 Rod Suspension
FN61F, FN62F (6x2) (6x4)	08-								6 Rod Suspension
FN63F (6x2) (6x4), FN64F (6x2) (6x4)	02-08	I/O	M85311	MC091948					
FN63F (6x2) (6x4), FN64F (6x2) (6x4)	08-					I/O	M85311	MK432143	

FP

FP415	8/88-	I/O	76103	MC035110		I/O	M85311 M89424	MC035111	
FP417	96-			MC091727		I/O	M85311 M89424	MC035111	
FP418	3/80- 8/88			MC804052				MC804625	
FP418, FP419, FP449	8/88-	I/O	76103	MC035110		I/O	M85311 M89424	MC035111	
FP547	98-			MK305349		O/O		MK316129	
FP54J (4x2)	02-08			MK305349		O/O		MK316129	
FP54J (4x2)	08-					O/O		MK316129	

FS

FS300 (NZ), FS310 (NZ)									
FS395 (NZ) Shogun		I/O	76103						
FS400 (NZ), FS402 (NZ)		I/O	76103						
FS410 (NZ) (8x4)		I/O	76103						1st & 2nd Axle
FS415 (NZ), FS416 (NZ), FS418 (NZ)	86-96	I/O		MC804052					
			M63320	MC091749					
FS433 (NZ) (8x4)	97-	I/O	76103						1st & 2nd Axle
FS435 (NZ) (8x4)	00-	I/O	M85311	MC091726					1st & 2nd Axle
FS510 (NZ)		I/O	76103	MC091047					
FS527	98-	I/O	M63320	MC570680					
FS527 (8x4)	98-	I/O	M63320	MC570680					1st Axle
		I/O	M85311	MC091726					2nd Axle

SYMBOLS



AIR	Air Suspension	TAP	Tapered Leaf Suspension	SS	Spring Suspension	TBS	Torsion Bar Suspension
PSS	Parabolic Spring Suspension	AEON	AEON Spring	TLS	Trapezium Leaf Suspension		
MLS	Multi Leaf Suspension	RBS	Rubber Block Suspension	IFS	Independant Front Suspension		

1. Please see the Cross Reference section of this catalog for a complete list of OE references.

2. Part number marked in **Bold Italic** represent the Premium, adjustable, heavy duty gas shock absorbers.



www.meritorpartsonline.com

		FRONT				REAR			
		Mount	MERITOR	OE	REMARKS	Mount	MERITOR	OE	REMARKS

MITSUBISHI



FS										
FS52J (8x4) S4RFAA (auto)	03-	I/O	M63320	MC570680	1st Axle					
		I/O	M85311	MC091726	2nd Axle					
		I/O	M63320	MC570680	Between Axles					
FS52J (8x4) S4RFAA (Manual)	03-	I/O	M85311	MK336182	1st Axle - RH					
			76103	MC091047	1st Axle - LH					
			M85311	MC091726	2nd Axle - RH & LH					
			M63320	MC570680	Between Axles					
FU										
FU225 (NZ)	01-	I/O	76103							
FU250 (NZ)	01-	I/O	M85311 M89424	MC091947						
FV										
FV113HR (NZ)										
FV330 (NZ), FV333 (NZ)		I/O	M85311 M89424							
FV393K (NZ), FV395H (NZ) FV395K (NZ)	97-	I/O	76103	MC091047				MK336497		
FV400 (NZ), FV401J (NZ) FV402J (NZ)	96-	I/O	76103							
FV403 (NZ)	95-					⊙/⊙	M85024 M89416			Reyco AIR
FV417 (NZ)	96	I/O	76103	MC035110						
FV418, FV418K, FV418KA FV418KS, FV419	83-96			MC804052 NC819334						
FV510 (NZ)	98-	I/O	76103	MC091047						
FV515 (NZ)	87	I/O	76103							
FV517	98-	I/O	76103	MC091047					MK316886	
				MK305349						
FV525 (NZ)								MK316129		AIR
FV547	98-	I/O	76103	MC091047					MK316886	
				MK305349						
FV54J (6x4) (NZ)				MK432057		I/O	M85311	MK432143		
FW										
FW280 (NZ)		I/O	M85311	MK432143						
MM										
MM FUSO (NZ)		O/O	M85304		short	O/O	M85305 M89425			
			M85308		long					

MOUNTING DIAGRAMS

⊙/⊙	Top Eye (with sleeve) / Bottom Eye (with sleeve)	I/I	Top Pin/Stud / Bottom Pin/Stud	⊙/⊙	Top Eye / Bottom Eye
⊙/⊙	Top Eye (with sleeve) / Bottom Eye	I/O	Top Pin/Stud / Bottom Eye	⊙/⊙	Top Eye / Bottom Pin/Stud
⊙/⊙	Top Eye (with sleeve) / Bottom Pin/Stud	I/O	Top Pin/Stud / Bottom Eye (with sleeve)	⊙/⊙	Top Eye / Bottom Eye (with sleeve)

1. Please see the Cross Reference section of this catalog for a complete list of OE references.
2. Part number marked in **Bold Italic** represent the Premium, adjustable, heavy duty gas shock absorbers.



		FRONT				REAR			
		Mount	MERITOR	OE	REMARKS	Mount	MERITOR	OE	REMARKS

NISSAN

Atlas

AKR66E (NZ)				8-97048434-3		I/O	M63320		
						O/O	M63299		
AKR66L (NZ)	95-					O/O	M85012 M89413		
EH40LR ATLAS (NZ)	83	I/O	M63320						
F22 ATLAS (NZ), F23 ATLAS (NZ) 2WD		I/O	69992			I/O	69992		
						O/O	M63299		
F22 ATLAS (NZ), F23 ATLAS (NZ) 4WD	90					O/O	M63173 M63178		
H40 ATLAS (NZ)	83	I/O	M63320						
H41 ATLAS (NZ)	92			56110-0T002		O/O	M85012 M89413		

Cabstar

	84-90	I/O				O/O	M63178		
	96-	I/O							

Cab All

	64-78	I/O	M63320	56110-82625		O/O	M63178		
	78-84	I/O	M63320	56110-82625		O/I	56157		
	96-	I/O							

OKA (4X4)

	92-	O/O	M85010		HD	O/O	M85010		
--	-----	-----	--------	--	-----------	-----	--------	--	--

PETERBUILT

		O/O	M85062 M89408	02 01787 02 02737 02 02742	Set Forward	I/O	M85311 M89424 M85033 M89427	03 04629 03 07421 03 05384	Air leaf, Air Trac AIR AIR
	98	O/O	M83309 M89446		Twin Steer				

SCAMMEL NZ

S26 (6x4) (8x4)		I/I	76041			I/O	2571		
-----------------	--	-----	-------	--	--	-----	------	--	--

SCANIA

80

L, LB		I/O	2479	216977					
-------	--	-----	------	--------	--	--	--	--	--

81

		I/O	2479	216977	MLS	I/I	2555	258420	
		I/O	2558	279011 307111 1110588	PSS	I/I	2555	258420	



SYMBOLS

AIR	Air Suspension	TAP	Tapered Leaf Suspension	SS	Spring Suspension	TBS	Torsion Bar Suspension
PSS	Parabolic Spring Suspension	AEON	AEON Spring	TLS	Trapezium Leaf Suspension		
MLS	Multi Leaf Suspension	RBS	Rubber Block Suspension	IFS	Independant Front Suspension		

1. Please see the Cross Reference section of this catalog for a complete list of OE references.

2. Part number marked in **Bold Italic** represent the Premium, adjustable, heavy duty gas shock absorbers.



		FRONT				REAR			
		Mount	MERITOR	OE	REMARKS	Mount	MERITOR	OE	REMARKS

SCANIA



82									
					MLS & PSS	I/I	2555	258420	4x2 MLS
						I/I	40121	216975	
						I/I	2215	328111	6x2 MLS
		I/O	2558	279011 307111 1110588		I/I	40121	279927	6x4 MLS
						I/I	2555	258420 1110589	4x2, 6x2/4 (Front or Rear Steer tag axle) PSS
							2571	272400 1110531 1307332 1309129	4x2, 6x2/4 (Front or Rear Steer tag axle) AIR
92									
					MLS & PSS	I/I	2555	395064	4x2 PSS
		I/O	2558	307111		I/I	4344	279927	6x2 PSS
						I/O	2571	1353105	6x4 AIR
93									
					4x2, 6x2, 6x2/4, 6x4 MLS & PSS	I/I	2555	1340253	4x2 PSS
						I/O	2562	1327813	
						I/I	40121	279927	6x2 PSS
						I/I	2555	1340253	6x2/4 (Front or Rear Steer tag axle) PSS
		I/O	2558	1110588 1111056 1315959 1340252 279111		I/O	2562	1327813	
						I/O	2571	1353105	6x4, 8x4 PSS
				1340252	8x4 Twin Steer MLS & PSS	I/O	2571	1303235 1323476 1340254 1353105 1377056	PSS
					AIR	I/I	2555	1340253	4x2 PSS
						I/O	2562	1327813	
						I/I	40121	279927	6x2 PSS
						I/I	2555	1340253	6x2/4 (Front or Rear Steer tag axle) PSS
		I/O	2562	1331756		I/O	2562	1327813	
						I/O	2571	1353105	6x4, 8x4 PSS
						I/O	2571	1303235 1323476 1340254 1353105 1377056	PSS

MOUNTING DIAGRAMS

O/O	Top Eye (with sleeve) / Bottom Eye (with sleeve)	I/I	Top Pin/Stud / Bottom Pin/Stud	O/O	Top Eye / Bottom Eye
O/O	Top Eye (with sleeve) / Bottom Eye	I/O	Top Pin/Stud / Bottom Eye	O/I	Top Eye / Bottom Pin/Stud
O/I	Top Eye (with sleeve) / Bottom Pin/Stud	I/O	Top Pin/Stud / Bottom Eye (with sleeve)	O/O	Top Eye / Bottom Eye (with sleeve)

1. Please see the Cross Reference section of this catalog for a complete list of OE references.
2. Part number marked in ***Bold Italic*** represent the Premium, adjustable, heavy duty gas shock absorbers.



		FRONT				REAR			
		Mount	MERITOR	OE	REMARKS	Mount	MERITOR	OE	REMARKS

SCANIA

94									
		I/O	2558	1370267 1381807 1388417 1420474 1421062	PSS	I/I	2555	1397525	PSS
						I/I	40121	1375832	
						I/O	2562	1327813	PSS
						O/O	40151	1380425 1397523	AIR
						O/O	40151	1380424	
110									
		I/O	2479	216977	MLS	I/I	2555	258420	4x2 MLS
							40121	216975	4x2 PSS
		I/O	2558	216976	PSS	I/I	2555	258420	4x2, 6x2 MLS
							40121	216975	4x2, 6x2 PSS
111									
		I/O	2479	216977	MLS	I/I	2555	258420	4x2 MLS
							40121	216975	4x2, 6x2 PSS
							2215	328111	6x4 PSS
		I/O	2558	216976	PSS	I/I	2555	258420	4x2 MLS
							40121	216975	4x2, 6x2 PSS
							2215	328111	6x4 PSS
112									
		I/O	2558	307111 395063 1110588 279011	MLS & PSS	I/I	2555	258420	4x2 MLS
							40121	216975	
						I/I	2215	328111	6x2 MLS
							2215	328111	6x4 MLS
						I/I	40121	279927	6x4 MLS
							4344	1110589 258420	4x2, 6x2/4 PSS
						I/O	2571	272400 1110531 1303235 1307332 1353105	4x2, 6x2, 6x4, 6x2/4, (Front or Rear Steer tag axle) AIR

SYMBOLS



AIR	Air Suspension	TAP	Tapered Leaf Suspension	SS	Spring Suspension	TBS	Torsion Bar Suspension
PSS	Parabolic Spring Suspension	AEON	AEON Spring	TLS	Trapezium Leaf Suspension		
MLS	Multi Leaf Suspension	RBS	Rubber Block Suspension	IFS	Independant Front Suspension		

1. Please see the Cross Reference section of this catalog for a complete list of OE references.

2. Part number marked in **Bold Italic** represent the Premium, adjustable, heavy duty gas shock absorbers.



www.meritorpartsonline.com

		FRONT				REAR			
		Mount	MERITOR	OE	REMARKS	Mount	MERITOR	OE	REMARKS



SCANIA

113									
	I/O	2558	1110588 1111056 1315959 1327211 1340252 1354966 1381807 279011 307111	MLS & PSS	I/I	2555	1110589 1340253	4x2, 6x2/4 MLS	
					I/I	4350	1340256 279927	6x4 MLS	
					I/I	2555	1110589 1397525 258420	4x2, 6x2 PSS	
					I/I	2555	1340253	6x2/4 (Front or Rear Steer tag axle) PSS	
					I/I	2215	328111		
					I/O	2562	1327813	6x4 PSS	
					I/O	2558	1342787	1st Drive Axle 8x4 PSS	
					I/O	2558	1342787	2nd Drive Axle 8x4 PSS	
					I/O	2571	1309129 1323476 1353105 1340254 1377056 272400	4x2, 6x2, 6x2/4, 6x4 AIR	
						I/O	2558	1111056	AIR
I/I	4350	1340256 279927	6x4 MLS						
I/I	2555	1110589 1397525 258420	4x2, 6x2 PSS						
I/I	2555	1340253	6x2/4 (Front or Rear Steer tag axle) PSS						
I/I	2215	328111							
I/O	2562	1327813	6x4 PSS						
I/O	2558	1342787	1st Drive Axle 8x4 PSS						
I/O	2558	1342787	2nd Drive Axle 8x4 PSS						
I/O	2571	1309129 1323476 1353105 1340254 1377056 272400	4x2, 6x2, 6x2/4, 6x4 AIR						

MOUNTING DIAGRAMS

O/O	Top Eye (with sleeve) / Bottom Eye (with sleeve)	I/I	Top Pin/Stud / Bottom Pin/Stud	O/O	Top Eye / Bottom Eye
O/O	Top Eye (with sleeve) / Bottom Eye	I/O	Top Pin/Stud / Bottom Eye	O/I	Top Eye / Bottom Pin/Stud
O/I	Top Eye (with sleeve) / Bottom Pin/Stud	I/O	Top Pin/Stud / Bottom Eye (with sleeve)	O/O	Top Eye / Bottom Eye (with sleeve)

1. Please see the Cross Reference section of this catalog for a complete list of OE references.
2. Part number marked in ***Bold Italic*** represent the Premium, adjustable, heavy duty gas shock absorbers.

		FRONT				REAR			
		Mount	MERITOR	OE	REMARKS	Mount	MERITOR	OE	REMARKS

SCANIA

114

		I/O	2558	1370267	MLS NZ					
				1370267 1381807 1388417	PSS	O/O	40151	1380425 1397523	4x2, 6x2, 6x4 Drive & tag axle AIR	

124

		I/O	2558	1370267 1381807 1388417 1420474 1421062	MLS & PSS	I/I	2555	1381808 1397525	4x2, 6x2 PSS
						I/I	40121	1375832	
						I/O	2571	1377058	
						I/O	2562	1327813	
		I/O	2558			I/O	2558	1342787	6x4 PSS
						I/O	2571	1353105	
		I/I				I/I	40121	1375832	8x4 PSS
		O/O				O/O	40151	1380425 1397523	4x2, 6x2 Drive Axle AIR
		I/O				I/O	2571	1353105	6x2 tag axle AIR
		O/O				O/O	40151	1380425	
		I/O	2566	1390898		O/O	50011	1380424	6x4, 8x4 Drive Axle AIR
						O/O	40151	1380425 1397523	
		I/O				I/O	2571	1353105	
		I/O	2566	1390898	AIR	I/I	2555	1381808 1397525	4x2, 6x2 PSS
						I/I	40121	1375832	
						I/O	2571	1377058	
		I/O				I/O	2562	1327813	6x4 PSS
				1478541	8x4 4 Bag 1st Axle AIR	I/O	2558	1342787	
						I/O	2571	1353105	
		I/I				I/I	40121	1375832	8x4 PSS
		O/O				O/O	40151	1380425 1397523	4x2, 6x2 Drive Axle AIR
	04-	I/O				I/O	2571	1353105	6x2 tag axle AIR
		O/O				O/O	40151	1380425	
		I/O	2084	1478501	8x4 4 Bag 2nd Axle AIR	O/O	50011	1380424	6x4, 8x4 Drive Axle AIR
						O/O	40151	1380425 1397523	
		I/O				I/O	2571	1353105	

SYMBOLS



AIR	Air Suspension	TAP	Tapered Leaf Suspension	SS	Spring Suspension	TBS	Torsion Bar Suspension
PSS	Parabolic Spring Suspension	AEON	AEON Spring	TLS	Trapezium Leaf Suspension		
MLS	Multi Leaf Suspension	RBS	Rubber Block Suspension	IFS	Independant Front Suspension		

1. Please see the Cross Reference section of this catalog for a complete list of OE references.

2. Part number marked in **Bold Italic** represent the Premium, adjustable, heavy duty gas shock absorbers.



www.meritorpartsonline.com

		FRONT				REAR			
		Mount	MERITOR	OE	REMARKS	Mount	MERITOR	OE	REMARKS

SCANIA

140 / 141

		I/O	2479	216977	MLS	I/I	2555	258420	4x2, 6x4 MLS	
								2555	258420	4x2 PSS
								40121	216975 279927	6x4 Front Drive Axle PSS
								2215	328111	6x4 Drive Axle PSS
		I/O	2558	216976	PSS	I/I	2555	258420	4x2, 6x4 MLS	
								2555	258420	4x2 PSS
								40121	216975 279927	6x4 Front Drive Axle PSS
								2215	328111	6x4 Drive Axle PSS



142

		I/O	2558	279011	MLS & PSS	I/I	2555	1110589 1381808 258420 395064	4x2 6x2 6x2/4 (Front or Rear Steer tag axle) PSS
							40121	216975 1340256	
						I/I	2555	258420	6x4 PSS
							40121	216975	
						I/O	2571	1110531 1303235 1309129 1353105 1377056 272400	4x2, 6x2, 6x2/4 AIR
		I/O	2571	1353105 1377056	6x4 AIR				

MOUNTING DIAGRAMS

O/O	Top Eye (with sleeve) / Bottom Eye (with sleeve)	I/I	Top Pin/Stud / Bottom Pin/Stud	O/O	Top Eye / Bottom Eye
O/O	Top Eye (with sleeve) / Bottom Eye	I/O	Top Pin/Stud / Bottom Eye	O/I	Top Eye / Bottom Pin/Stud
O/I	Top Eye (with sleeve) / Bottom Pin/Stud	I/O	Top Pin/Stud / Bottom Eye (with sleeve)	O/O	Top Eye / Bottom Eye (with sleeve)

1. Please see the Cross Reference section of this catalog for a complete list of OE references.
2. Part number marked in ***Bold Italic*** represent the Premium, adjustable, heavy duty gas shock absorbers.

		FRONT				REAR			
		Mount	MERITOR	OE	REMARKS	Mount	MERITOR	OE	REMARKS

SCANIA



143

Mount	MERITOR	OE	REMARKS	Mount	MERITOR	OE	REMARKS				
I/O	2558	1012044 1012045 1315959 1340252 216976 307055 307111 395063	MLS & PSS	I/I	2555	258420 1110589 1381808 1340253	4x2, 6x2 PSS				
					4350	216975 1340256					
				I/O	2558	1111056 1327211	AIR	I/I	2555	1340253 395064	6x2, 6x4 (Front or Rear tag axle) PSS
								I/O	2562	1327813	6x4 PSS
				I/I				2555	1381808		
								4350	1340256 1375832 216975		
	I/I	2215	1340255 328111								
	I/I	2555	395064	8x4 PSS							
	I/O	2562	1327145 1331756	AIR	I/O	2571	272400 1323476 1340254 1377056 1377058 1381809	4x2, 6x2, 6x2/4 (Front or Rear Steer tag axle) AIR			
					I/O	2571	1307332 1323476 1353105 1377056 1381809	6x4, 8x4 AIR			

SYMBOLS

AIR	Air Suspension	TAP	Tapered Leaf Suspension	SS	Spring Suspension	TBS	Torsion Bar Suspension
PSS	Parabolic Spring Suspension	AEON	AEON Spring	TLS	Trapezium Leaf Suspension		
MLS	Multi Leaf Suspension	RBS	Rubber Block Suspension	IFS	Independant Front Suspension		

1. Please see the Cross Reference section of this catalog for a complete list of OE references.
2. Part number marked in **Bold Italic** represent the Premium, adjustable, heavy duty gas shock absorbers.

		FRONT				REAR			
		Mount	MERITOR	OE	REMARKS	Mount	MERITOR	OE	REMARKS

SCANIA



144										
		I/O	2558	1356723 1370267 1381807 1388417 1421062	MLS or PSS	I/I	2555	1397525	MLS	
						I/I	2555	1381808	4x2, 6x2 PSS	
						I/I	40121	1375832		
						I/O	2562	1327813		
						I/O	2571	1353105 1377057 1377058		
						I/I	40121	1375832	6x4 PSS	
						I/O	2562	1327813		
						I/O	2558	1342787 1371417		
			I/O	2571	1353105 1377057	4x2, 6x2 AIR				
			O/O	40151	1380425 1397523					
			I/O	2571	1307332 1353105	6x2 tag axle AIR				
			O/O	40151	1380425 1397523					
			O/O	40151	1380424 1478506	6x4, 8x4 Drive Axle AIR				
			I/O	2571	1307332 1353105					
			O/O	40151	1380425 1397523					

MOUNTING DIAGRAMS

O/O	Top Eye (with sleeve) / Bottom Eye (with sleeve)	I/I	Top Pin/Stud / Bottom Pin/Stud	O/O	Top Eye / Bottom Eye
O/O	Top Eye (with sleeve) / Bottom Eye	I/O	Top Pin/Stud / Bottom Eye	O/I	Top Eye / Bottom Pin/Stud
O/I	Top Eye (with sleeve) / Bottom Pin/Stud	I/O	Top Pin/Stud / Bottom Eye (with sleeve)	O/O	Top Eye / Bottom Eye (with sleeve)

1. Please see the Cross Reference section of this catalog for a complete list of OE references.
2. Part number marked in ***Bold Italic*** represent the Premium, adjustable, heavy duty gas shock absorbers.



		FRONT				REAR			
		Mount	MERITOR	OE	REMARKS	Mount	MERITOR	OE	REMARKS

SCANIA

164

		I/O	2558	1381807	MLS	I/I	2215	1381810	MLS
						I/I	2555	1397525	
						I/O	2571	1377057 1478503	
			2558	1356723 1370267 1388417 1421062	PSS	I/I	2555	1381808 1397525	4x2, 6x2, 6x4 PSS
						I/I	40121	1375832	
						I/O	2562	1327813	
		I/O				2558	1342787 1371417		
		I/O				2571	1353105 1377057 1377058		
		O/O				40151	1380425 1397523	4x2, 6x2 AIR	
		2566	1390898	AIR	I/O	2571	1353105	6x2 tag axle AIR	
					O/O	40151	1380425 1397523		
					O/O	40151	1380424 1478506	6x4, 8x4 Drive Axle AIR	
I/O	2571				1353105				
O/O	40151				1380425 1397523				
O/O	40151				1380425 1397523				

P (270, 280, 310, 340, 360, 380, 400, 420)

4x2		I/O	2558	1370267	PSS	O/O	40151	1519630	4x2 2 Bag AIR
								1397523	6x4 4 Bag AIR
6x2, 6x4		I/O	2558	1420474	PSS	O/O	40151	1519630	4x2 2 Bag AIR
								1397523	6x4 4 Bag AIR
8x4		I/O	2084	1478541	1st Axle AIR	O/O	40151	1519630	4x2 2 Bag AIR
				1478501	2nd Axle AIR			1397523	6x4 4 Bag AIR

SYMBOLS



AIR	Air Suspension	TAP	Tapered Leaf Suspension	SS	Spring Suspension	TBS	Torsion Bar Suspension
PSS	Parabolic Spring Suspension	AEON	AEON Spring	TLS	Trapezium Leaf Suspension		
MLS	Multi Leaf Suspension	RBS	Rubber Block Suspension	IFS	Independant Front Suspension		

1. Please see the Cross Reference section of this catalog for a complete list of OE references.

2. Part number marked in **Bold Italic** represent the Premium, adjustable, heavy duty gas shock absorbers.



www.meritorpartsonline.com

		FRONT				REAR			
		Mount	MERITOR	OE	REMARKS	Mount	MERITOR	OE	REMARKS

SCANIA

R (380, 420, 470, 480, 500, 560, 580, 620)

		I/O	2558	1370267	6x4 PSS	O/O	40151	1397523	6x4 4 Bag AIR 8x2/4 Drive Axle 4 Bag AIR 8x2/4 Lift Axle 4 Bag AIR 8x4 4 Bag AIR
				1478541	1st Axle AIR	O/O	40151	1397523	6x4 4 Bag AIR 8x2/4 Drive Axle 4 Bag AIR 8x2/4 Lift Axle 4 Bag AIR 8x4 4 Bag AIR
		I/O	2084	1478501	2nd Axle AIR				

SEDDON NZ (ALSO REFER ATKINSON)

T38		I/I	M83318						
STRATU		I/O	M85311						

STERLING (ALSO REFER FORD)



LT7500 HN

							M85724 M89443	16-15817-000 16-13957-000 16-13957-003	Airliner 23K, 40K, 46K AIR
		O/O	M85054 M89438	F6HT-18045-CC F6HZ-18124-C	MLS or PSS	O/O	M85013	47902-024 57905-001 60670-005	Hendrickson HAS400, HAS460 AIR
							M83144	60670-007 60670-007L 60675-006 60675-006L	
							M85072	60657-3 60657-003	Hendrickson PAX Primax AIR
							M85956	16-15770-000	AirlinerTuftrac 40K, 46K AIR

MOUNTING DIAGRAMS

O/O	Top Eye (with sleeve) / Bottom Eye (with sleeve)	I/I	Top Pin/Stud / Bottom Pin/Stud	O/O	Top Eye / Bottom Eye
O/O	Top Eye (with sleeve) / Bottom Eye	I/O	Top Pin/Stud / Bottom Eye	O/I	Top Eye / Bottom Pin/Stud
O/I	Top Eye (with sleeve) / Bottom Pin/Stud	I/O	Top Pin/Stud / Bottom Eye (with sleeve)	O/O	Top Eye / Bottom Eye (with sleeve)

1. Please see the Cross Reference section of this catalog for a complete list of OE references.
2. Part number marked in **Bold Italic** represent the Premium, adjustable, heavy duty gas shock absorbers.

		FRONT				REAR			
		Mount	MERITOR	OE	REMARKS	Mount	MERITOR	OE	REMARKS

STERLING (ALSO REFER FORD)

LT7500 HX

		O/O	M85054 M89438	F6HT-18045-CC F6HZ-18124-C	MLS or PSS	O/O	M85724 M89443	16-15817-000 16-13957-000 16-13957-003	Airliner 23K, 40K, 46K AIR				
							M85013	47902-024 57905-001 60670-005	Hendrickson HAS400, HAS460 AIR				
							M83144	60670-007 60670-007L 60675-006 60675-006L					
							2007-	O/O	M85918 M89449	10-13684-000	M85072	60657-3 60657-003	Hendrickson PAX Primax AIR
							M85956	16-15770-000	AirlinerTuftrac 40K, 46K AIR				

AT9500 HN

		O/O	M85054 M89438	F6HT-18045-CC F6HZ-18124-C	MLS or PSS	O/O	M85724 M89443	16-15817-000 16-13957-000 16-13957-003	Airliner 23K, 40K, 46K AIR
							M85013	47902-024 57905-001 60670-005	Hendrickson HAS400, HAS460 AIR
							M83144	60670-007 60670-007L 60675-006 60675-006L	
							M85072	60657-3 60657-003	Hendrickson PAX Primax AIR
							M85909	90045132	Neway AD246 AIR 10" ride height (~ 2000)
							M85030 M89440	3501001 90045504	Neway AD246 AIR 10" ride height (2000 ~)
							M85956	16-15770-000	AirlinerTuftrac 40K, 46K AIR

SYMBOLS



AIR	Air Suspension	TAP	Tapered Leaf Suspension	SS	Spring Suspension	TBS	Torsion Bar Suspension
PSS	Parabolic Spring Suspension	AEON	AEON Spring	TLS	Trapezium Leaf Suspension		
MLS	Multi Leaf Suspension	RBS	Rubber Block Suspension	IFS	Independant Front Suspension		

1. Please see the Cross Reference section of this catalog for a complete list of OE references.

2. Part number marked in **Bold Italic** represent the Premium, adjustable, heavy duty gas shock absorbers.



www.meritorpartsonline.com

		FRONT				REAR			
		Mount	MERITOR	OE	REMARKS	Mount	MERITOR	OE	REMARKS



STERLING (ALSO REFER FORD)

LT9500 HN									
							M85724 M89443	16-15817-000 16-13957-000 16-13957-003	Airliner 23K, 40K, 46K AIR
							M85013	47902-024 57905-001 60670-005	Hendrickson HAS400, HAS460 AIR
							M83144	60670-007 60670-007L 60675-006 60675-006L	
		O/O	M85054 M89438	F6HT-18045-CC	MLS	O/O	M85072	60657-3 60657-003	Hendrickson PAX Primax AIR
							M85909	90045132	Neway AD246 AIR 10" ride height (~ 2000)
							M85030 M89440	3501001 90045504	Neway AD246 AIR 10" ride height (2000 ~)
							M85956	16-15770-000	AirlinerTuftrac 40K, 46K AIR

LT9500 HX (inc. Premium)									
							M85724 M89443	16-15817-000 16-13957-000 16-13957-003	Airliner 23K, 40K, 46K AIR
		O/O	M85054 M89438	F6HT-18045-CC F6HZ-18124-C	PSS	O/O	M85072	60657-3 60657-003	Hendrickson PAX Primax AIR
							M85956	16-15770-000	AirlinerTuftrac 40K, 46K AIR
	2007-	O/O	M85918 M89449	10-13684-000	PSS	O/O	M85724 M89443	16-15817-000 16-13957-000 16-13957-003	Airliner 23K, 40K, 46K AIR
							M85072	60657-3 60657-003	Hendrickson PAX Primax AIR
							M85956	16-15770-000	AirlinerTuftrac 40K, 46K AIR

MOUNTING DIAGRAMS					
O/O	Top Eye (with sleeve) / Bottom Eye (with sleeve)	I/I	Top Pin/Stud / Bottom Pin/Stud	O/O	Top Eye / Bottom Eye
O/O	Top Eye (with sleeve) / Bottom Eye	I/O	Top Pin/Stud / Bottom Eye	O/I	Top Eye / Bottom Pin/Stud
O/I	Top Eye (with sleeve) / Bottom Pin/Stud	I/O	Top Pin/Stud / Bottom Eye (with sleeve)	O/O	Top Eye / Bottom Eye (with sleeve)

1. Please see the Cross Reference section of this catalog for a complete list of OE references.
2. Part number marked in **Bold Italic** represent the Premium, adjustable, heavy duty gas shock absorbers.

		FRONT				REAR			
		Mount	MERITOR	OE	REMARKS	Mount	MERITOR	OE	REMARKS

TOYOTA

Dyna

DA, FA, FC	65-75	I/O	M63322			O/O	M63178		
------------	-------	-----	--------	--	--	-----	--------	--	--

BU

BU10,12	5/70-8/77	O/O	M63299	48511-39065		O/O	M63178	48531-69015	single wheel
							M63173	48531-39115	dual wheel
BU15	2/72-8/77	O/O	M63299	48511-39065		O/O	M63178	48531-69015	
BU20, BU30	8/77-10/79	I/O	M63211	48511-39225 48511-39226					
BU20, BU30, BU40, BU50	10/79-8/84	I/O	M63211	48511-39225 48511-39226 48511-39355		O/O	M63299	48531-29276 48511-39515	
BU60, BU61	9/84-8/87	I/O	M63211	48511-36150 48511-39505		O/O	M63299	48531-39715	single & dual wheel
	8/87-94	I/O	M63211	48511-36150					
BU62	9/84-8/87	I/O	M63211	48511-36150 48511-39505		O/O	M63299	48531-39715	single & dual wheel
	8/87-8/88	I/O	M63211						
BU63, BU65	9/84-8/87	I/O	M63211	48511-36150 48511-39505		O/O	M63299	48531-39715	single & dual wheel
BU65	8/87-	I/O	M63211	48511-36150 48511-39505					
BU66	8/88-94	I/O	M63211			O/O	M63173	48511-36070	dual wheel
BU67	9/84-8/87	I/O	M63211	48511-36150 48511-39505		O/O	M63299	48531-39715	single & dual wheel
BU70	9/84-94	I/O	M63211						single wheel
BHU72 (NZ)	89-91	I/O	M63320			O/O	M63299		
BU73 4x4 (NZ)	92-	I/O	M63211						
BU75, BU76, BU80, BU81	9/84-8/87	I/O	M63211	48511-36150 48511-39505		O/O	M63299	48531-39715	dual wheel
BU84	8/88-94	I/O	M63211						dual wheel
BU85	9/84-8/87	I/O	M63211	48511-39495 48511-39505 48511-39535		O/O	M63178		
BU86	9/84-8/87	I/O	M63211			O/O	M63299	48531-39715	dual wheel
BU87, BU88	8/84-94	I/O	M63211			O/O	M63178		
BU90	9/84-	I/O	M63211	48511-39495 48511-39505 48511-39535					
BU91	8/87-8/88	I/O	M63211			O/O	M63178		
	8/88-94	I/O	M63211						

SYMBOLS



AIR	Air Suspension	TAP	Tapered Leaf Suspension	SS	Spring Suspension	TBS	Torsion Bar Suspension
PSS	Parabolic Spring Suspension	AEON	AEON Spring	TLS	Trapezium Leaf Suspension		
MLS	Multi Leaf Suspension	RBS	Rubber Block Suspension	IFS	Independant Front Suspension		

1. Please see the Cross Reference section of this catalog for a complete list of OE references.

2. Part number marked in **Bold Italic** represent the Premium, adjustable, heavy duty gas shock absorbers.



www.meritorpartsonline.com

		FRONT				REAR			
		Mount	MERITOR	OE	REMARKS	Mount	MERITOR	OE	REMARKS

TOYOTA



BU									
BU93	8/87-8/88	I/O	M63211			O/O	M63178		
BU95	9/84-	I/O	M63211	48511-39495 48511-39505 48511-39535					
BU96	8/88-94	I/O	M63211						dual wheel
BU100						O/O	M63173 M63178	48511-80442 48531-36120 48531-80445	
BU102	90-	I/O	M63299			O/O	M63173		
BU105 (NZ), BU106(NZ), BU107 (NZ)						O/O	M63173		
BU142R	99-	I/O	M63211	48511-36150	long wheel base	O/O	M63178	48531-36120	
BU145 (NZ), BU147 (NZ)						O/O	M63178		
BU202	97-			48511-36220					
BU212	99-	I/O	M63211	48511-36140 48511-80035	16mm lower mount	O/O	M63178	48531-36120 48531-80445	
					19mm lower mount	O/O	M63178	48531-36120 48531-80445	
BU222R	99-			48511-80018 48511-80019		O/O	M63178	48531-36120 48531-80445	
BU306 (NZ)	00					O/O	M63178		
HU									
HU30	8/77-10/79	I/O	M63211	48511-39225 48511-39226 48511-39305 48511-39306					
HU30	10/79-84	I/O	M63211	48511-39225 48511-39226 48511-39305 48511-39306		O/O	M63299	48531-39276	dual wheel
HU40, HU50	4/82-8/84	I/O	M63211	48511-39226 48511-39355		O/O	M63299	48531-39515	
JU									
JU10, JU12, JU15	5/70-	O/O	M63299	48511-39065		O/O	M63178	48531-69015	single wheel
							M63173	49531-39115	dual wheel
JU20	8/77-10/79	I/O	M63211	48511-39225 48511-39226				48531-39285	single wheel
	10/79-8/84	I/O	M63211	48511-39225 48511-39226		O/O	M63299	48531-39455	single wheel

MOUNTING DIAGRAMS

O/O	Top Eye (with sleeve) / Bottom Eye (with sleeve)	I/I	Top Pin/Stud / Bottom Pin/Stud	O/O	Top Eye / Bottom Eye
O/O	Top Eye (with sleeve) / Bottom Eye	I/O	Top Pin/Stud / Bottom Eye	O/I	Top Eye / Bottom Pin/Stud
O/I	Top Eye (with sleeve) / Bottom Pin/Stud	I/O	Top Pin/Stud / Bottom Eye (with sleeve)	O/O	Top Eye / Bottom Eye (with sleeve)

1. Please see the Cross Reference section of this catalog for a complete list of OE references.
2. Part number marked in ***Bold Italic*** represent the Premium, adjustable, heavy duty gas shock absorbers.



		FRONT				REAR			
		Mount	MERITOR	OE	REMARKS	Mount	MERITOR	OE	REMARKS

TOYOTA

LY

LY50, LY60 (NZ), TOYO ACE	85-	I/O	M63211			O/O	M63299		
LY61, LY81	85-	I/O	M63211			O/O	M63178		
LY101N (NZ)		I/O	69992	48511-26090					
LY112 (NZ), LY161 (NZ)		I/O	69992	48511-26190		O/O		48531-26150	
LY211R, DYNA	95-	I/O	69992	48511-26090		O/O		48531-26150	

RU

RU10, RU12, RU15	5/70-	O/O	M63299	48511-39065		O/O	M63178	48531-69015	single wheel
							M63173	49531-39115	dual wheel
RU15	2/72-8/77	O/O	M63299	48511-39065		O/O	M63178	48531-69015	
RU20	8/77-10/79	I/O	M63211	48511-39225 48511-39226					
	10/79-8/84	I/O	M63211	48511-39225 48511-39226		O/O	M63299	48531-29276	dual wheel
RU30		I/O	M63211	48511-39225 48511-39226		O/O	M63299	48531-30080	

WU

WU40, WU50	4/82-8/84	I/O	M63211	48511-39226 48511-39355		O/O	M63299	48531-39515	
WU90	9/84-	I/O	M63211	48511-39495 48511-39525 48511-39535				48531-39725	
WU90	8/87-94	I/O	M63211						

YU

YU60, YU62	9/84-8/88	I/O	M63211	48511-36150 48511-39505		O/O	M63299	48531-39715	single & dual wheels
YU62	8/88-94	I/O	M63211						single wheel
YU70, YU71		I/O	M63211	48511-36150 48511-39505		O/O	M63299	48531-39715	
YU71	8/88-94	I/O	M63211						single wheel
YU80, YU81	8/84-8/87	I/O	M63211	48511-36150 48511-39505					
YU81, YU90	8/87-8/88	I/O	M63211						dual wheel

YY

YY50, TOYO ACE	90-	I/O	M63320						
----------------	-----	-----	--------	--	--	--	--	--	--

SYMBOLS



AIR	Air Suspension	TAP	Tapered Leaf Suspension	SS	Spring Suspension	TBS	Torsion Bar Suspension
PSS	Parabolic Spring Suspension	AEON	AEON Spring	TLS	Trapezium Leaf Suspension		
MLS	Multi Leaf Suspension	RBS	Rubber Block Suspension	IFS	Independant Front Suspension		

1. Please see the Cross Reference section of this catalog for a complete list of OE references.

2. Part number marked in **Bold Italic** represent the Premium, adjustable, heavy duty gas shock absorbers.



www.meritorpartsonline.com

		FRONT				REAR			
		Mount	MERITOR	OE	REMARKS	Mount	MERITOR	OE	REMARKS

UD

CG

CG380 (NZ), CG400 (NZ), CG450 Twin Steer		I/O	76103						
--	--	-----	-------	--	--	--	--	--	--

CGA

CGA45, CGA46	7/84-6/91	I/O	76103	56101-Z2005 56101-Z2006 56101-Z2009					
--------------	-----------	-----	-------	---	--	--	--	--	--

CGB

CG450, CGB450	11/91-	I/O	76103	56101-Z2004					
---------------	--------	-----	-------	-------------	--	--	--	--	--

CK

CK10, CK20, CK30	12/72-10/79	I/O	M85311	56101-Z2000 56101-Z2001 56101-Z2002					
CK31	10/79-	I/O	76103	56101-Z2004	Chassis ~ 010324				
				56101-Z2006	Chassis 010324 ~				
CK40	72-4/77	I/O	M85311	56101-Z1030 56101-Z2000		I/O	M85311 M89424	56110-90112	
CK40, CK41	5/77-	I/O	M85311	56101-Z1030 56101-Z2000		I/O	M85311	56101-Z2000	
CK45	12/79-	I/O	76103	56101-Z2004					
CK50	72-4/77	I/O	M85311	56101-Z1030 56101-Z2000		I/O	M85311 M89424	56110-90112	
	5/77-	I/O	M85311	56101-Z1030 56101-Z2000		I/O	M85311	56101-Z2000	
	12/79-	I/O	76103	56101-Z2004					
CK60	72-4/77	I/O	M85311	56101-Z1030 56101-Z2000		I/O	M85311 M89424	56110-90112	
	5/77-2/79	I/O	M85311						
	12/79-	I/O	76103	56101-Z2004					
CK60BT (NZ) IMPORT	84-	I/O	M63320						
CK109 (NZ)		I/O	M63322			I/O	M85311		
CK235	98-	I/O	M63322						
CK320, CK330, CK350	97-	I/O	76103	56101-00Z00	25mm lower mount	O/O	M83121	56210-00Z07 58715-1 60665-008	Hendrickson HAS AIR
				56210-00Z01	30mm lower mount				
CK450		I/O	76103	56101-00Z00					



CKA

CKA31 (NZ)		I/O	76103						
CKA45	-87	I/O	76103	56101-Z2004 56101-Z2005 56101-Z2006					
CKA46	88-91	I/O	76103	56101-Z2009		I/O		56210-Z0000	

MOUNTING DIAGRAMS

O/O	Top Eye (with sleeve) / Bottom Eye (with sleeve)	I/I	Top Pin/Stud / Bottom Pin/Stud	O/O	Top Eye / Bottom Eye
O/O	Top Eye (with sleeve) / Bottom Eye	I/O	Top Pin/Stud / Bottom Eye	O/I	Top Eye / Bottom Pin/Stud
O/I	Top Eye (with sleeve) / Bottom Pin/Stud	I/O	Top Pin/Stud / Bottom Eye (with sleeve)	O/O	Top Eye / Bottom Eye (with sleeve)

- Please see the Cross Reference section of this catalog for a complete list of OE references.
- Part number marked in **bold italic** represent the Premium, adjustable, heavy duty gas shock absorbers.

		FRONT				REAR			
		Mount	MERITOR	OE	REMARKS	Mount	MERITOR	OE	REMARKS



UD									
CKB									
CKB450, CKB452, CKB455	11/91-	I/O	76103	56101-00Z00 56101-00Z02		I/O		56210-Z0005	
						O/O	M85013	56210-00Z11 98583-006	Hendrickson 19mm mounts
						O/O	M83121	56210-00Z07 58715-1 60665-008	Hendrickson 20mm mounts
CLG									
CLG87, CLG88	6/89-	I/O	M63320	56110-Z5016		I/I	M83318	56210-Z5002	
CM									
CM80, CM85, CM86, CM87, CM88 (NZ), CM90	12/79- 8/83	I/O	M63320	56101-Z5000 56101-Z5008 56101-Z5009		I/I	M83318	56101-Z5001 56110-Z5001	
CM180 (NZ)		I/O	M63320						
CMA									
CMA81, CMA86, CMA87	10/83-	I/O	M83114	56101-Z5008 56101-Z5009		I/I	M83318	56101-Z5001 56110-Z5001	
CMB									
CMB87	1/88- 7/89	I/O	M83114	56101-Z5008 56101-Z5009		I/I	M83318	56101-Z5001 56110-Z5001	
CMF									
CMF87, CMF88	89-	I/O	M83114	56101-Z5008		I/I	M83318	56101-Z5001 56110-Z5001	
CP									
CP88L (NZ)	89	I/O	M63322						
CP180 (NZ), CP200 (NZ), CP210 (NZ)	94-	I/O							
CPA									
CPA87	89-	I/O	M63320	56101-Z5016 56110-Z5016	16mm lower mount				
		I/O	M63322	56101-Z5017	22mm lower mount				
CPB									
CPB12	7/85-	I/O	M85311	56101-Z1030 56101-Z2000 56101-Z2001 56101-Z2002					
CPB12, CPB14, CPB87, CPB88	7/87-	I/O	M63322	56101-Z5014 56101-Z5017		I/I	M83318	56101-Z5001 56110-Z5001	

SYMBOLS

AIR	Air Suspension	TAP	Tapered Leaf Suspension	SS	Spring Suspension	TBS	Torsion Bar Suspension
PSS	Parabolic Spring Suspension	AEON	AEON Spring	TLS	Trapezium Leaf Suspension		
MLS	Multi Leaf Suspension	RBS	Rubber Block Suspension	IFS	Independant Front Suspension		

1. Please see the Cross Reference section of this catalog for a complete list of OE references.
2. Part number marked in **Bold Italic** represent the Premium, adjustable, heavy duty gas shock absorbers.



		FRONT				REAR			
		Mount	MERITOR	OE	REMARKS	Mount	MERITOR	OE	REMARKS

UD

CPC

CPC12	1/88-	I/O	M85311	56101-Z1030 56101-Z2000 56101-Z2001 56101-Z2002					
CPC12	89-	I/O	M63448		19mm lower mount				
CPC14, CPC15	5/89-	I/O	M63322	56101-Z5014 56101-Z5017	22mm lower mount				

CV

CV31	72-5/76	I/O	M85311	56101-Z2000 56101-Z2001 56101-Z2002					
CV32	5/76- 10/79	I/O	M85311	56101-Z1030					
CV40	72-5/76	I/O	M85311	56101-Z2000 56101-Z2001 56101-Z2002					
	10/79- 4/83	I/O	76103	56101-Z2004					
CV41	4/76- 9/86	I/O	M85311	56101-Z1030					
CV46	5/83-	I/O	76103	56101-Z2004					
CV50, CV51	10/79-	I/O	76103	56101-Z2004					
CV55	4/78-	I/O	M85311	56101-Z2000					
CV56	10/79-	I/O	76103	56101-Z2004					

CW



CW15, CW40, CW41	72-12/89	I/O	M85311	56101-Z1030 56101-Z2000 56101-Z2001 56101-Z2002					
CW45	10/79- 4/83	I/O	76103	56101-Z2004	Chassis ~ 14999				
				56101-Z2005	Chassis 15000 ~				
CW46	5/83-	I/O	76103	56101-Z2005 56101-Z2006					
CW50, CW51	72-3/80	I/O	M85311	56101-Z1030 56101-Z2000 56101-Z2001 56101-Z2002					
CW51, CW52, CW53, CW54	10/79-	I/O	76103	56101-Z2004 56101-Z2005 56101-Z2006					
CW60	1/79- 1/80	I/O	M85311	56101-Z2000					
CW60, CW61, CW66	1/80-	I/O	76103	56101-Z2004 56101-Z2005 56101-Z2006					

MOUNTING DIAGRAMS

O/O	Top Eye (with sleeve) / Bottom Eye (with sleeve)	I/I	Top Pin/Stud / Bottom Pin/Stud	O/O	Top Eye / Bottom Eye
O/O	Top Eye (with sleeve) / Bottom Eye	I/O	Top Pin/Stud / Bottom Eye	O/I	Top Eye / Bottom Pin/Stud
O/I	Top Eye (with sleeve) / Bottom Pin/Stud	I/O	Top Pin/Stud / Bottom Eye (with sleeve)	O/O	Top Eye / Bottom Eye (with sleeve)

1. Please see the Cross Reference section of this catalog for a complete list of OE references.
2. Part number marked in **Italic** represent the Premium, adjustable, heavy duty gas shock absorbers.



		FRONT				REAR			
		Mount	MERITOR	OE	REMARKS	Mount	MERITOR	OE	REMARKS

UD

CW

CW240, CW250	95-	I/O	M63322	56101-Z5014 56110-Z5014 56101-Z5017 56110-Z5017					
CW290	6/96-	I/O	76103	56101-00Z00 56110-00Z00					
CW320, CW330 (NZ), CW350	96-	I/O	76103	56101-00Z00 56110-00Z00	MLS	O/O	M85013	56210-00Z11 58715-002 60665-001 98583-005 98583-006	Hendrickson HAS AIR 19mm mounts
							M83121	56210-00Z07 58715-001 60665-008	Hendrickson HAS AIR 20mm mounts
					TLS	O/O	M85013	56210-00Z11 58715-002 60665-001 98583-005 98583-006	Hendrickson HAS AIR 19mm mounts
							M83121	56210-00Z07 58715-001 60665-008	Hendrickson HAS AIR 20mm mounts
CW380	00-	I/O	76103	56101-00Z00 56110-00Z00		O/O	M85013	56210-00Z11 58715-002 60665-001 98583-005 98583-006	Hendrickson HAS AIR 19mm mounts
							M83121	56210-00Z07 58715-001 60665-008	Hendrickson HAS AIR 20mm mounts
CW385 (6x4)		I/O	76103	56101-00Z00 56110-00Z00		O/O	M85013	56210-00Z11 58715-002 60665-001 98583-005 98583-006	Hendrickson HAS AIR 19mm mounts
							M83121	56210-00Z07 58715-001 60665-008	Hendrickson HAS AIR 20mm mounts
CW400E (NZ)				56101-Z2011 56110-Z2011					
CW420	97-	I/O	76103	56101-00Z00 56110-00Z00	MLS				
				56101-Z2011 56110-Z2011	TLS				

SYMBOLS



AIR	Air Suspension	TAP	Tapered Leaf Suspension	SS	Spring Suspension	TBS	Torsion Bar Suspension
PSS	Parabolic Spring Suspension	AEON	AEON Spring	TLS	Trapezium Leaf Suspension		
MLS	Multi Leaf Suspension	RBS	Rubber Block Suspension	IFS	Independant Front Suspension		

1. Please see the Cross Reference section of this catalog for a complete list of OE references.

2. Part number marked in **Bold Italic** represent the Premium, adjustable, heavy duty gas shock absorbers.



www.meritorpartsonline.com

		FRONT				REAR			
		Mount	MERITOR	OE	REMARKS	Mount	MERITOR	OE	REMARKS

UD

CW									
CW440E	02-	I/O	76103	56101-00Z00 56110-00Z00	MLS	O/O	M85013	56210-00Z11 58715-002 60665-001 98583-005 98583-006	Hendrickson HAS AIR 19mm mounts
				56101-Z2011 56110-Z2011	TLS		M83121	56210-00Z07 58715-001 60665-008	Hendrickson HAS AIR 20mm mounts
CW445 (6x4) inc. Fleet	03-					O/O	M85013	56210-00Z11 58715-002 60665-001 98583-005 98583-006	Hendrickson HAS AIR 19mm mounts
							M83121	56210-00Z07 58715-001 60665-008	Hendrickson HAS AIR 20mm mounts
CW450	91-	I/O	76103	56101-00Z00 56110-00Z00	MLS	O/O	M85013	56210-00Z11 58715-002 60665-001 98583-005 98583-006	Hendrickson HAS AIR
				56101-Z2011 56110-Z2011	TLS				
CW620 (NZ)	95-	I/O	76103						



CWA

CWA12, CWA14	7/90-	I/O	M85311	56101-Z1030 56101-Z2000 56101-Z2001 56101-Z2002					
CWA15	92-	I/O	M63322	56101-Z5014 56110-Z5014 56101-Z5017 56110-Z5017					
CWA20 (NZ), CWA31 (NZ), CWA41 (NZ)		I/O	76103						
CWA45, CWA46	1/80- 6/91	I/O	76103	56101-Z2004 56101-Z2005 56101-Z2006					
CWA52 (NZ)	84-91	I/O	76103						
CWA53		I/O	76103	56101-Z2005 56101-Z2006					
CWA70, CWA71	84-91	I/O	76103	56101-Z2004 56101-Z2005 56101-Z2006					
CWA310	96-	I/O	M63322	56101-Z5014 56110-Z5014					
CWA340 (NZ)		I/O	M85311						
CWA445 (6x4) inc. Fleet						O/O	M85013	98583-016	Hendrickson HAS AIR

MOUNTING DIAGRAMS

O/O	Top Eye (with sleeve) / Bottom Eye (with sleeve)	I/I	Top Pin/Stud / Bottom Pin/Stud	O/O	Top Eye / Bottom Eye
O/O	Top Eye (with sleeve) / Bottom Eye	I/O	Top Pin/Stud / Bottom Eye	O/I	Top Eye / Bottom Pin/Stud
O/I	Top Eye (with sleeve) / Bottom Pin/Stud	I/O	Top Pin/Stud / Bottom Eye (with sleeve)	O/O	Top Eye / Bottom Eye (with sleeve)

1. Please see the Cross Reference section of this catalog for a complete list of OE references.
2. Part number marked in ***Italic*** represent the Premium, adjustable, heavy duty gas shock absorbers.

		FRONT				REAR			
		Mount	MERITOR	OE	REMARKS	Mount	MERITOR	OE	REMARKS

UD



CWB

CWB290, CWB320, CWB350	95-	I/O	76103	56101-00Z00 56110-00Z00	MLS	O/O	M85013	56210-00Z11 58715-002 60665-001 98583-005 98583-006	Hendrickson HAS AIR 19mm mounts
				56101-Z2008 56101-Z2011 56110-Z2011	TLS		M83121	56210-00Z07 58715-001 60665-008	Hendrickson HAS AIR 20mm mounts
CWB440, CWB450, CWB452		I/O	76103	56101-00Z00 56110-00Z00 56101-00Z02	MLS	O/O	M85013	56210-00Z11 58715-002 60665-001 98583-005 98583-006	Hendrickson HAS AIR 19mm mounts
							M83121	56210-00Z07 58715-001 60665-008	Hendrickson HAS AIR 20mm mounts
		I/O		56101-Z2008 56110-Z2008 56101-Z2011 56110-Z2011	TLS	O/O	M85013	56210-00Z11 58715-002 60665-001 98583-005 98583-006	Hendrickson HAS AIR 19mm mounts
							M83121	56210-00Z07 58715-001 60665-008	Hendrickson HAS AIR 20mm mounts
CWB481, CWB483				56110-00Z11		O/O	M85013	56210-00Z11 58715-002 60665-001 98583-005 98583-006	Hendrickson HAS AIR 19mm mounts
							M83121	56210-00Z07 58715-001 60665-008	Hendrickson HAS AIR 20mm mounts
CWB536		I/O	76103	56101-30Z02 56110-30Z02					
CWB545	98-	I/O	76103	56101-00Z00 56110-00Z00	MLS	O/O	M85013	56210-00Z11 58715-002 60665-001 98583-005 98583-006	Hendrickson HAS AIR 19mm mounts
							M83121	56210-00Z07	Hendrickson HAS AIR 20mm mounts
		I/O		56101-Z2011 56110-Z2011	TLS	O/O	M85013	56210-00Z11 58715-002 60665-001 98583-005 98583-006	Hendrickson HAS AIR 19mm mounts
							M83121	56210-00Z07	Hendrickson HAS AIR 20mm mounts

SYMBOLS

AIR	Air Suspension	TAP	Tapered Leaf Suspension	SS	Spring Suspension	TBS	Torsion Bar Suspension
PSS	Parabolic Spring Suspension	AEON	AEON Spring	TLS	Trapezium Leaf Suspension		
MLS	Multi Leaf Suspension	RBS	Rubber Block Suspension	IFS	Independant Front Suspension		



1. Please see the Cross Reference section of this catalog for a complete list of OE references.
2. Part number marked in **Bold Italic** represent the Premium, adjustable, heavy duty gas shock absorbers.

		FRONT				REAR			
		Mount	MERITOR	OE	REMARKS	Mount	MERITOR	OE	REMARKS

UD									
H									
H40 (NZ) Condor 2 & 3 tonne	81-91	I/O	M63320			O/I	56157		
H41 (NZ) Condor 2, 2.75 & 3 tonne	91					O/O	M85012 M89413		
LG									
LG46 (NZ) Twin Steer		I/O	76043						
LK									
LK160 (NZ)	99	I/O	M63320						
LK185	96-	I/O	M63211	56101-30Z02 56110-30Z02		I/I	M83318	56210-Z5002	
LK235 (4x2)	98-	I/O	M63211	56101-30Z02 56110-30Z02					
LK245 (4x2)	05-	I/O	M63211	56101-30Z02 56110-30Z02					
LK251 (NZ)	99	I/O	M63320						
LK260BN (NZ)		I/O	M63320	56110-30Z05					
LKA									
LKA200	98-	I/O	M63211	56101-30Z02					
LKA265 (4x2)	05-	I/O	M63211	56101-30Z02 56110-30Z02		O/O	M85013	98583-006 98583-016	Hendrickson HAS AIR
LKC									
LKC183, LKC210		I/O	M63211	56101-30Z02 56110-30Z02		I/I	M83318	56210-Z5002	
MD									
MD125 (NZ), MD235 (NZ)						O/O	M85030 M89440		Reyco AIR
MK									
MK150	99-	I/O	M83114	56101-Z5008 56101-30Z01 56110-30Z01					
MK175, MK175T	05-	I/O	M63320	56101-Z5016 56110-Z5016					
MK180	98-	I/O	M63320	56101-30Z01 56110-30Z01		I/I	M83318	56101-Z5001 56110-Z5001	
MK185		I/O	M63320	56101-30Z01 56110-30Z01		I/I	M83318	56101-Z5001 56110-Z5001	
MK190	02-	I/O	M83114	56101-Z5008 56101-30Z01 56110-30Z01 56101-30Z05		I/I	M83318	56101-Z5001 56110-Z5001	
MK195 (NZ), MK205 (NZ), MK210 (NZ), MK211 (NZ)		I/O	M83114	56101-Z5008 56101-30Z01 56110-30Z01					

MOUNTING DIAGRAMS					
O/O	Top Eye (with sleeve) / Bottom Eye (with sleeve)	I/I	Top Pin/Stud / Bottom Pin/Stud	O/O	Top Eye / Bottom Eye
O/O	Top Eye (with sleeve) / Bottom Eye	I/O	Top Pin/Stud / Bottom Eye	O/I	Top Eye / Bottom Pin/Stud
O/I	Top Eye (with sleeve) / Bottom Pin/Stud	I/O	Top Pin/Stud / Bottom Eye (with sleeve)	O/O	Top Eye / Bottom Eye (with sleeve)

1. Please see the Cross Reference section of this catalog for a complete list of OE references.
2. Part number marked in **Bold Italic** represent the Premium, adjustable, heavy duty gas shock absorbers.

		FRONT				REAR			
		Mount	MERITOR	OE	REMARKS	Mount	MERITOR	OE	REMARKS

UD									
MK									
MK225		I/O	M83114	56101-Z5008 56101-30Z01 56110-30Z01		I/I	M83318	56101-Z5001 56110-Z5001	
MK235	94-00	I/O	M63320	56101-30Z01 56110-30Z01 56101-30Z05		I/I	M83318	56101-Z5001 56110-Z5001	
MK240 (4x2)		I/O	M63320	56101-30Z01 56110-30Z01					
MK245 (4x2)	05-	I/O	M63320	56101-30Z01 56110-30Z01 56101-30Z05		I/I	M83318	56101-Z5001 56110-Z5001	
MK250 (NZ)		I/O	M83114	56101-Z5008 56101-30Z01 56110-30Z01 56101-30Z05					
MK265 (4x2)	05-	I/O	M63320	56110-Z5008		I/I	M83318	56101-Z5001 56110-Z5001	
MK5		I/O	M63320	56110-30Z05					
MK6		I/O	M63320	56110-30Z05					
MKA									
MKA245 (4x2), MKA265 (4x2)	05-	I/O	M63320	56101-30Z05		O/O	M85013	98583-016	Hendrickson HAS AIR
MKB									
MKB123, MKB185, MKB210		I/O	M83114	56101-Z5008 56101-30Z01 56110-30Z01 56101-30Z05		I/I	M83318	56101-Z5001 56110-Z5001	
NK									
NK252 (NZ)	00-	I/O	M63320						
PE									
PE6H	85	O/O	M85308 M89422						

SYMBOLS



AIR	Air Suspension	TAP	Tapered Leaf Suspension	SS	Spring Suspension	TBS	Torsion Bar Suspension
PSS	Parabolic Spring Suspension	AEON	AEON Spring	TLS	Trapezium Leaf Suspension		
MLS	Multi Leaf Suspension	RBS	Rubber Block Suspension	IFS	Independant Front Suspension		

1. Please see the Cross Reference section of this catalog for a complete list of OE references.

2. Part number marked in **Bold Italic** represent the Premium, adjustable, heavy duty gas shock absorbers.



www.meritorpartsonline.com

		FRONT				REAR			
		Mount	MERITOR	OE	REMARKS	Mount	MERITOR	OE	REMARKS

UD

PK

PK205 (NZ)		I/O	M85311					
PK220, PK235, PK240		I/O	M63322	56101-Z5014 56110-Z5014 56101-Z5017 56110-Z5017				
PK245	05-	I/O	M63322	56101-30Z10 56110-30Z10				
PK250	98-	I/O	M63322	56101-Z5014 56110-Z5014 56101-Z5017 56110-Z5017				
PK255		I/O	M63322	56101-30Z10 56110-30Z10				
PK265	05-	I/O	M63322	56101-30Z10 56110-30Z10				
PK9, PK10	08-	I/O	M63322	56110-Z5014				

PKA

PKA220	-98	I/O	M63322	56101-Z5014 56110-Z5014 56101-Z5017 56110-Z5017				
PKA220	98-	I/O	M63322	56101-Z5014 56110-Z5014 56101-Z5017 56110-Z5017	O/O	M85013	56210-00Z11 58715-002 60665-001 98583-005 98583-006	Hendrickson HAS AIR 19mm mounts
PKA220	98-	I/O	M63322	56101-Z5014 56110-Z5014 56101-Z5017 56110-Z5017	O/O	M83121	56210-00Z07 58715-001 60665-008	Hendrickson HAS AIR 20mm mounts
PKA245, PKA265	05-	I/O	M63322	56101-30Z10 56110-30Z10	O/O	M85013	98583-016	Hendrickson HAS AIR

PKC

PKC210		I/O	76103					
PKC215, PKC310		I/O	M63322	56101-30Z10 56110-30Z10				

PM

PM87BD (NZ) Condor		I/O	M63320	56101-Z5000	I/I	M83318	56101-Z5001 56110-Z5001	
--------------------	--	-----	--------	-------------	-----	--------	----------------------------	--

S

S41 (NZ) Condor 2, 2.75 & 3 tonne		I/O			O/O	M85012 M89413		
--------------------------------------	--	-----	--	--	-----	-------------------------	--	--

T



TFA21, TZA52	8/82- 3/90	I/O	M63448 M85311	56110-Z2000				
TW50 (NZ), TW53 (NZ), TWA51 (NZ)	72-79	I/O	M85311	56110-Z2000 56101-Z2001 56110-Z2002				

MOUNTING DIAGRAMS

O/O	Top Eye (with sleeve) / Bottom Eye (with sleeve)	I/I	Top Pin/Stud / Bottom Pin/Stud	O/O	Top Eye / Bottom Eye
O/O	Top Eye (with sleeve) / Bottom Eye	I/O	Top Pin/Stud / Bottom Eye	O/I	Top Eye / Bottom Pin/Stud
O/I	Top Eye (with sleeve) / Bottom Pin/Stud	I/O	Top Pin/Stud / Bottom Eye (with sleeve)	O/O	Top Eye / Bottom Eye (with sleeve)

1. Please see the Cross Reference section of this catalog for a complete list of OE references.
2. Part number marked in **Bold Italic** represent the Premium, adjustable, heavy duty gas shock absorbers.



		FRONT				REAR			
		Mount	MERITOR	OE	REMARKS	Mount	MERITOR	OE	REMARKS

VOLVO

F7

4x2, 6x2, 6x4	78-86	O/O	4199	1505184 1590431 1590439		I/I		1591501 1598814 8153538	4x2 SS
						I/O	2527	1612217 1629993	T-RIDE SS
						O/O	40275	1610920	S-RIDE, 6x4 SS
						I/I	4319	8153538	4x2, 6x2 AIR
8x2, 8x4	78-86	I/I	76041	8152712		I/I		1591501 1598814 8153538	4x2 SS
						I/O	2527	1612217 1629993	T-RIDE SS
						O/O	40275	1610920	S-RIDE, 6x4 SS
						I/I	4319	8153538	4x2, 6x2 AIR

F10



		O/O	4047	362960	MLS	I/I		1591501 8153538	4x2 MLS
						I/I		1591501 1598814 8153538	4x2 PSS
		O/O	2526	1591735 1591737		O/O	40275	1599623 1610920	S-RIDE 6x2 SS
						O/I	2527	1612217 1629993	T&B RIDE 6x4, 8x4 SS
						I/I	4319	8153538	4x2 AIR
						O/I	40013	1598105	
		O/O	40275	1609603		I/I	4319	8153538	6x2 AIR
						O/I	40019	1605163	
			O/I	2527	1612217	T&B RIDE 6x4, 8x4 AIR			
				4417	1629993				

SYMBOLS

AIR	Air Suspension	TAP	Tapered Leaf Suspension	SS	Spring Suspension	TBS	Torsion Bar Suspension
PSS	Parabolic Spring Suspension	AEON	AEON Spring	TLS	Trapezium Leaf Suspension		
MLS	Multi Leaf Suspension	RBS	Rubber Block Suspension	IFS	Independant Front Suspension		

1. Please see the Cross Reference section of this catalog for a complete list of OE references.

2. Part number marked in **Bold Italic** represent the Premium, adjustable, heavy duty gas shock absorbers.

		FRONT				REAR			
		Mount	MERITOR	OE	REMARKS	Mount	MERITOR	OE	REMARKS



VOLVO

F10									
		O/O	4199	1505184 1505185 1591736 1608888	PSS	I/I		1591501 8153538	4x2 MLS
						I/I		1591501 1598814 8153538	4x2 PSS
						O/O	40275	1599623 1610920	S-RIDE 6x2 SS
						O/I	2527	1612217	T&B RIDE 6x4, 8x4 SS
						I/I	4319	8153538	4x2 AIR
		O/I	40013	1598105					
		O/O	40275	1609553		I/I	4319	8153538	6x2 AIR
						O/I	40019	1605163	
						O/I	2527	1612217	T&B RIDE 6x4, 8x4 AIR
							4417	1629993	
8x4 Twin Steer					I/I	76041	8152712	PSS	I/I
		I/I		1591501 1598814 8153538					4x2 PSS
		O/O	40275	1599623					S-RIDE 6x2 SS
		O/I	2527	1612217					T&B RIDE 6x4, 8x4 SS
		I/I	4319	8153538					4x2 AIR
		O/I	40013	1598105					
		I/I	4319	8153538					6x2 AIR
		O/I	2527	1612217					T&B RIDE 6x4, 8x4 AIR
		O/O	40018	1609001	AIR	I/I		1591501	4x2 SS
						O/O	40275	1599623	S-RIDE 6x2 SS
						O/I	2527	1612217	T&B RIDE 6x4, 8x4 SS
						I/I	4319	8153538	4x2 AIR
			O/I	40013		1598105			
			I/I	4319		8153538	6x2 AIR		
								O/I	40019
			O/I	2527		1612217	T&B RIDE 6x4, 8x4 AIR		
4417	1629993								

MOUNTING DIAGRAMS

O/O	Top Eye (with sleeve) / Bottom Eye (with sleeve)	I/I	Top Pin/Stud / Bottom Pin/Stud	O/O	Top Eye / Bottom Eye
O/O	Top Eye (with sleeve) / Bottom Eye	I/O	Top Pin/Stud / Bottom Eye	O/I	Top Eye / Bottom Pin/Stud
O/I	Top Eye (with sleeve) / Bottom Pin/Stud	I/O	Top Pin/Stud / Bottom Eye (with sleeve)	O/O	Top Eye / Bottom Eye (with sleeve)

1. Please see the Cross Reference section of this catalog for a complete list of OE references.
2. Part number marked in ***Bold Italic*** represent the Premium, adjustable, heavy duty gas shock absorbers.

		FRONT				REAR			
		Mount	MERITOR	OE	REMARKS	Mount	MERITOR	OE	REMARKS

VOLVO



F12

		FRONT			REAR				
Mount	MERITOR	OE	REMARKS	Mount	MERITOR	OE	REMARKS		
		O/O	4047	362960	MLS	I/I		1591501	4x2 SS
						O/O	40275	1610920	S-RIDE 6x2 SS
						O/O	40275	1609553	W-RIDE 6x4 SS
						O/I	2527	1612217	T&B RIDE 6x4, 8x4 SS
						I/I	4319	8153538	4x2 AIR
						O/I	40013	1598105	
		O/O	2526	1591735		I/I	4319	8153538	6x2 AIR
						O/I	40019	1605163	
		O/O	2524	1591737		O/O	2525	1696100	6x2 tag axle AIR
						O/O	40275	1610920	S-RIDE AIR
						O/I	2527	1612217	B-RIDE 6x4, 8x4 AIR
						O/I	40019	1605163	6x4, 8x4 AIR
O/O	40275				1609603	M85024 M89416	8071524	6x4 USA AIR	
O/O						M85046 M89434	8026658		
		O/O	4199	1608888	PSS	I/I		1591501	4x2 SS
						O/O	40275	1610920	S-RIDE 6x2 SS
						O/O	40275	1609553	W-RIDE 6x4 SS
						O/I	2527	1612217	T&B RIDE 6x4, 8x4 SS
						I/I	4319	8153538	4x2 AIR
						O/I	40013	1598105	
		O/O	40275	1609553		I/I	4319	8153538	6x2 AIR
						O/I	40019	1605163	
		O/O	40275	1609553		O/O	2525	1696100	6x2 tag axle AIR
						O/O	40275	1610920	S-RIDE AIR
						O/I	2527	1612217	B-RIDE 6x4, 8x4 AIR
						O/I	40019	1605163	6x4, 8x4 AIR
O/O	40275				1609553	M85024 M89416	8071524	6x4 USA AIR	
O/O						M85046 M89434	8026658		

SYMBOLS

AIR	Air Suspension	TAP	Tapered Leaf Suspension	SS	Spring Suspension	TBS	Torsion Bar Suspension
PSS	Parabolic Spring Suspension	AEON	AEON Spring	TLS	Trapezium Leaf Suspension		
MLS	Multi Leaf Suspension	RBS	Rubber Block Suspension	IFS	Independant Front Suspension		

1. Please see the Cross Reference section of this catalog for a complete list of OE references.
2. Part number marked in **Bold Italic** represent the Premium, adjustable, heavy duty gas shock absorbers.

		FRONT				REAR			
		Mount	MERITOR	OE	REMARKS	Mount	MERITOR	OE	REMARKS



VOLVO

F12									
4x4, 6x6		O/O	4199	1568340	PSS	I/I		1591501	4x2 SS
						O/O	40275	1610920	S-RIDE 6x2 SS
						O/O	40275	1609553	W-RIDE 6x4 SS
						O/I	2527	1612217	T&B RIDE 6x4, 8x4 SS
						I/I	4319	8153538	4x2 AIR
						O/I	40013	1598105	
						I/I	4319	8153538	6x2 AIR
						O/I	40019	1605163	
						O/O	2525	1696100	6x2 tag axle AIR
						O/O	40275	1610920	S-RIDE AIR
						O/I	2527	1612217	B-RIDE 6x4, 8x4 AIR
						O/I	40019	1605163	6x4, 8x4 AIR
						O/O	M85024 M89416	8071524	6x4 USA AIR
						O/O	M85046 M89434	8026658	
8x4 Twin Steer		I/I	76041	8030367	PSS	I/I		1591501	4x2 SS
						O/O	40275	1610920	S-RIDE 6x2 SS
						O/O	40275	1609553	W-RIDE 6x4 SS
						O/I	2527	1612217	T&B RIDE 6x4, 8x4 SS
						I/I	4319	8153538	4x2 AIR
						O/I	40013	1598105	
						I/I	4319	8153538	6x2 AIR
		O/I	40019	1605163					
		O/O	40275	1609553		O/O	2525	1696100	6x2 tag axle AIR
						O/O	40275	1610920	S-RIDE AIR
						O/I	2527	1612217	B-RIDE 6x4, 8x4 AIR
						O/I	40019	1605163	6x4, 8x4 AIR
						O/O	M85024 M89416	8071524	6x4 USA AIR
						O/O	M85046 M89434	8026658	

MOUNTING DIAGRAMS

O/O	Top Eye (with sleeve) / Bottom Eye (with sleeve)	I/I	Top Pin/Stud / Bottom Pin/Stud	O/O	Top Eye / Bottom Eye
O/O	Top Eye (with sleeve) / Bottom Eye	I/O	Top Pin/Stud / Bottom Eye	O/I	Top Eye / Bottom Pin/Stud
O/I	Top Eye (with sleeve) / Bottom Pin/Stud	I/O	Top Pin/Stud / Bottom Eye (with sleeve)	O/O	Top Eye / Bottom Eye (with sleeve)

1. Please see the Cross Reference section of this catalog for a complete list of OE references.
2. Part number marked in **Bold Italic** represent the Premium, adjustable, heavy duty gas shock absorbers.

		FRONT				REAR			
		Mount	MERITOR	OE	REMARKS	Mount	MERITOR	OE	REMARKS

VOLVO

F12

Mount	MERITOR	OE	REMARKS	Mount	MERITOR	OE	REMARKS	
O/O	40018	1609001	AIR	I/I		1591501	4x2 SS	
				O/O	40275	1610920	S-RIDE 6x2 SS	
				O/O	40275	1609553	W-RIDE 6x4 SS	
				O/I	2527	1612217	T&B RIDE 6x4, 8x4 SS	
				I/I	4319	8153538	4x2 AIR	
				O/I	40013	1598105		
				I/I	4319	8153538	6x2 AIR	
	O/I	40019	1605163					
	O/O	40016	1609002	AIR	O/O	2525	1696100	6x2 tag axle AIR
	O/O				40275	1610920	S-RIDE AIR	
	O/I				2527	1612217	B-RIDE 6x4, 8x4 AIR	
	O/I				40019	1605163	6x4, 8x4 AIR	
	O/O				M85024 M89416	8071524	6x4 USA AIR	
	O/O				M85046 M89434	8026658		

F16

O/O	40275	1609553 8159833	SS	I/I		1591501 1598814 8153538	4x2 PSS
				O/O	40275	1610920	S-RIDE 6x2 SS
				O/O	40275	1609553	W-RIDE 6x4 SS
				O/I	2527	1612217 1629993	T&B RIDE 6x4, 8x4 SS
				O/I	40013	1598105	4x2 AIR
				O/I	40019	1605163	6x2 AIR
				O/I	40019	1605163	6x4 AIR
O/O	40018	1609001	AIR	I/I		1591501 1598814 8153538	4x2 PSS
				O/O	40275	1610920	S-RIDE 6x2 SS
				O/O	40275	1609553	W-RIDE 6x4 SS
	40016	1609002	AIR	O/I	2527	1612217 1629993	T&B RIDE 6x4, 8x4 SS
				O/I	40013	1598105	4x2 AIR
				O/I	40019	1605163	6x2 AIR
				O/I	40019	1605163	6x4 AIR

SYMBOLS



AIR	Air Suspension	TAP	Tapered Leaf Suspension	SS	Spring Suspension	TBS	Torsion Bar Suspension
PSS	Parabolic Spring Suspension	AEON	AEON Spring	TLS	Trapezium Leaf Suspension		
MLS	Multi Leaf Suspension	RBS	Rubber Block Suspension	IFS	Independant Front Suspension		

1. Please see the Cross Reference section of this catalog for a complete list of OE references.

2. Part number marked in **Bold Italic** represent the Premium, adjustable, heavy duty gas shock absorbers.





www.meritorpartsonline.com

		FRONT				REAR			
		Mount	MERITOR	OE	REMARKS	Mount	MERITOR	OE	REMARKS

VOLVO									
F86									
	66-71	O/O	4047	362960					
F88, F89 (Also refer G88, G89, N88)									
	66-	O/O	4047	362960					
	74-	O/O	4199	1591736					
F727 Twin Steer									
	80-	I/I	76041	8030367					
FE (4x2) (6x2) (6x4)									
(4x2, 6x2, 6x4)				20806285 20806286 20906906 20906911	PSS	O/O		20726482	RAD-A4 (6x2) 4 Bag AIR
								20725479	RADD-A8 (6x4) 8 Bag AIR
FH12 / FH13									
					PSS	I/I	40121	1629477	4x2, 6x2 Drive Axle SS
						O/I	2527	1612217 1629405 1629993	6x4, 8x4 SS
						O/I	2527	1612217	4x2 AIR
							40119	1629476	
							40111	1629482 1629484	
						O/I	40111	1629482 1629484	6x2 AIR
						O/I	2527	1612217	6x4, 8x4 8 Bag AIR
						O/I	40119	1629476	
						O/I	40111	1629483	
						O/O	40009	20374543 20585556 20766063 21232663	
		O/O	2595	1629485 1629992 3171962 3987957 3987958 20374546 20374548					

MOUNTING DIAGRAMS					
O/O	Top Eye (with sleeve) / Bottom Eye (with sleeve)	I/I	Top Pin/Stud / Bottom Pin/Stud	O/O	Top Eye / Bottom Eye
O/O	Top Eye (with sleeve) / Bottom Eye	I/O	Top Pin/Stud / Bottom Eye	O/I	Top Eye / Bottom Pin/Stud
O/I	Top Eye (with sleeve) / Bottom Pin/Stud	I/O	Top Pin/Stud / Bottom Eye (with sleeve)	O/O	Top Eye / Bottom Eye (with sleeve)

1. Please see the Cross Reference section of this catalog for a complete list of OE references.
2. Part number marked in **Bold Italic** represent the Premium, adjustable, heavy duty gas shock absorbers.

		FRONT				REAR			
		Mount	MERITOR	OE	REMARKS	Mount	MERITOR	OE	REMARKS

VOLVO

FH12 / FH13

		O/O	2774	3987959	AIR	I/I	40121	1629477	4x2, 6x2 Drive Axle SS		
						O/I	2527	1612217 1629405 1629993	6x4, 8x4 SS		
			O/I	2527	1612217	4x2 AIR					
				40119	1629476						
				40111	1629482 1629484						
		O/I	40111	1629482 1629484	6x2 AIR						
		2593				1629481 1629920 3987961	AIR	O/I	2527	1612217	6x4, 8x4 8 Bag AIR
								O/I	40119	1629476	
								O/I	40111	1629483	
								O/O	40009	20374543 20585556 20766063 21232663	



FH15

	02-	O/O	2595	20374548 20374549		O/O	40009	20374543 20585556 20766063 21232663	8 Bag Air RADD-A8 AIR
--	-----	-----	------	----------------------	--	-----	-------	--	------------------------------------

SYMBOLS

AIR	Air Suspension	TAP	Tapered Leaf Suspension	SS	Spring Suspension	TBS	Torsion Bar Suspension
PSS	Parabolic Spring Suspension	AEON	AEON Spring	TLS	Trapezium Leaf Suspension		
MLS	Multi Leaf Suspension	RBS	Rubber Block Suspension	IFS	Independant Front Suspension		

1. Please see the Cross Reference section of this catalog for a complete list of OE references.
2. Part number marked in **Bold Italic** represent the Premium, adjustable, heavy duty gas shock absorbers.

		FRONT				REAR			
		Mount	MERITOR	OE	REMARKS	Mount	MERITOR	OE	REMARKS

VOLVO



FH16

		O/O	2595	20374548	PSS	I/I	40121	1629477	4x2, 6x2 Drive Axle SS
						O/I	2527	1612217	6x4, 8x4 SS
							40120	1629405	
							4417	1629993	
						O/I	40111	1629482	4x2, CHH STD 4 Bag AIR
						O/I	2527	1612217	CHH 850 AIR
							40119	1629476	
						O/I	40111	1629484	CHH 900 AIR
						O/I	40111	1629483	6x2 Forward & Rear Axle 6 Bag AIR
1629484									
O/O	40009	20374543 20585556 20766063 21232663	6x4, 8x4 8 Bag AIR						
		O/O	2774	3987959	AIR	I/I	40121	1629477	4x2, 6x2 Drive Axle SS
						O/I	2527	1612217	6x4, 8x4 SS
							40120	1629405	
							4417	1629993	
						O/I	40111	1629482	4x2, CHH STD 4 Bag AIR
						O/I	2527	1612217	CHH 850 AIR
							40119	1629476	
						O/I	40111	1629484	CHH 900 AIR
						O/I	40111	1629483	6x2 Forward & Rear Axle 6 Bag AIR
1629484									
O/O	40009	20374543 20585556 20766063 21232663	6x4, 8x4 8 Bag AIR						
FH440, FH480, FH500, FH520, FH565, FH580, FH660 (6x4) (8x4)									
6x4		O/O	4416	20374546		O/O	40009	20374543 20585556 20766063 21232663	8 Bag Air RADD-A8 AIR
			2595	20374548					

MOUNTING DIAGRAMS

O/O	Top Eye (with sleeve) / Bottom Eye (with sleeve)	I/I	Top Pin/Stud / Bottom Pin/Stud	O/O	Top Eye / Bottom Eye
O/O	Top Eye (with sleeve) / Bottom Eye	I/O	Top Pin/Stud / Bottom Eye	O/I	Top Eye / Bottom Pin/Stud
O/I	Top Eye (with sleeve) / Bottom Pin/Stud	I/O	Top Pin/Stud / Bottom Eye (with sleeve)	O/O	Top Eye / Bottom Eye (with sleeve)

1. Please see the Cross Reference section of this catalog for a complete list of OE references.
2. Part number marked in ***Bold Italic*** represent the Premium, adjustable, heavy duty gas shock absorbers.

		FRONT				REAR			
		Mount	MERITOR	OE	REMARKS	Mount	MERITOR	OE	REMARKS

VOLVO

FL6

					MLS	O/O	2525	6775414	SS
		O/O	2769	3953642		O/O	M83101	6794746 6790175	6x4 4 Bag AIR
				3953650		O/I	2527	1612217	6x4 AIR
							4417	1628359	
							40120	1629405	
						O/I	4417	1629993	
					O/I	40111	1629483	6x4, 8x4 8 Bag AIR	
					PSS	O/O	2525	6775414	SS
		O/O	2563	3953644		O/O	M83101	6794746 6790175	6x4 4 Bag AIR
						O/I	2527	1612217	6x4 AIR
							4417	1628359	
							40120	1629405	
						O/I	4417	1629993	
					O/I	40111	1629483	6x4, 8x4 8 Bag AIR	
					AIR	O/O	2525	6775414	SS
		O/O	2774	3987959		O/O	M83101	6794746 6790175	6x4 4 Bag AIR
						O/I	2527	1612217	6x4 AIR
							4417	1628359	
							40120	1629405	
						O/I	4417	1629993	
					O/I	40111	1629483	6x4, 8x4 8 Bag AIR	
FL6E (4x2) (6x2) (6x4)									
						O/O	40003	20374544 20401856 20585555	4x2 4 Bag 6x2, 6x4 8 Bag AIR
FL6H (4x2)									
						O/O	40003	20374544 20401856 20585555	4x2 2 Bag AIR

SYMBOLS



AIR	Air Suspension	TAP	Tapered Leaf Suspension	SS	Spring Suspension	TBS	Torsion Bar Suspension
PSS	Parabolic Spring Suspension	AEON	AEON Spring	TLS	Trapezium Leaf Suspension		
MLS	Multi Leaf Suspension	RBS	Rubber Block Suspension	IFS	Independant Front Suspension		

1. Please see the Cross Reference section of this catalog for a complete list of OE references.

2. Part number marked in **Bold Italic** represent the Premium, adjustable, heavy duty gas shock absorbers.



www.meritorpartsonline.com

		FRONT				REAR			
		Mount	MERITOR	OE	REMARKS	Mount	MERITOR	OE	REMARKS



VOLVO

FL7									
	O/O	40275	1609603	MLS	I/I	4319	8153538	4x2 SS	
					O/O	40275	1610920	6x2 S-RIDE SS	
					O/I	2527	1612217	6x4 8x4 T&B RIDE SS	
					O/O	40275	1609553	6x4 W-RIDE SS	
					O/I	40013	1598105	4x2 AIR	
							1609005		
					O/I	40019	1605163	6x2 AIR	
					O/I	40019	1605163	6x4 AIR	
					O/O	M85046 M89434	8026658	6x4 USA AIR	
O/I	40111	1629483	6x4 8 Bag AIR						
	O/O	40275	1609553	4x2, 6x2, 6x4 AIR	I/I	4319	8153538	4x2 SS	
					O/O	40275	1610920	6x2 S-RIDE SS	
					O/I	2527	1612217	6x4 8x4 T&B RIDE SS	
					O/O	40275	1609553	6x4 W-RIDE SS	
			O/I	40013	1598105	4x2 AIR			
					1609005				
			O/I	40019	1605163	6x2 AIR			
			O/I	40019	1605163	6x4 AIR			
			O/O	M85046 M89434	8026658	6x4 USA AIR			
O/I	40111	1629483	6x4 8 Bag AIR						
	O/O	40275	1610921	8x2, 8x4 AIR	I/I	4319	8153538	4x2 SS	
					O/O	40275	1610920	6x2 S-RIDE SS	
					O/I	2527	1612217	6x4 8x4 T&B RIDE SS	
					O/O	40275	1609553	6x4 W-RIDE SS	
			O/I	40013	1598105	4x2 AIR			
					1609005				
			O/I	40019	1605163	6x2 AIR			
			O/I	40019	1605163	6x4 AIR			
			O/O	M85046 M89434	8026658	6x4 USA AIR			
O/I	40111	1629483	6x4 8 Bag AIR						

MOUNTING DIAGRAMS

O/O	Top Eye (with sleeve) / Bottom Eye (with sleeve)	I/I	Top Pin/Stud / Bottom Pin/Stud	O/O	Top Eye / Bottom Eye
O/O	Top Eye (with sleeve) / Bottom Eye	I/O	Top Pin/Stud / Bottom Eye	O/I	Top Eye / Bottom Pin/Stud
O/I	Top Eye (with sleeve) / Bottom Pin/Stud	I/O	Top Pin/Stud / Bottom Eye (with sleeve)	O/O	Top Eye / Bottom Eye (with sleeve)

1. Please see the Cross Reference section of this catalog for a complete list of OE references.
2. Part number marked in **Bold Italic** represent the Premium, adjustable, heavy duty gas shock absorbers.

		FRONT				REAR			
		Mount	MERITOR	OE	REMARKS	Mount	MERITOR	OE	REMARKS

VOLVO

FL10 / FL12

		O/O	40275	1609603	MLS	I/I	4319	8153538	4x2 SS
						O/O	40275	1610920	6x2 S-RIDE SS
						O/O	40275	1609553	W-RIDE SS
						O/I	2527	1612217 1629993	6x4, 8x4 T&B RIDE SS
						O/I	40013	1598105	4x2 AIR
		O/O	4199	1568340	4x4, 6x6 MLS	O/I	40013	1605163	6x2 Drive Axle AIR
						O/I	40013	1605163	6x4 AIR
						O/O	M85046 M89434	8026658	6x4 USA AIR
						O/I	40111	1629483	6x4, 8x4 8 Bag AIR
						O/I	40013	1605163	6x4 AIR
		O/O	40275	1609553 1609603 1610921 8151708 8159833	PSS	I/I	4319	8153538	4x2 SS
						O/O	40275	1610920	6x2 S-RIDE SS
						O/O	40275	1609553	W-RIDE SS
						O/I	2527	1612217 1629993	6x4, 8x4 T&B RIDE SS
						O/I	40013	1598105	4x2 AIR
						O/I	40013	1605163	6x2 Drive Axle AIR
						O/I	40013	1605163	6x4 AIR
						O/O	M85046 M89434	8026658	6x4 USA AIR
						O/I	40111	1629483	6x4, 8x4 8 Bag AIR
								O/O	40018
O/O	40275	1610920	6x2 S-RIDE SS						
O/O	40275	1609553	W-RIDE SS						
O/I	2527	1612217 1629993	6x4, 8x4 T&B RIDE SS						
O/I	40013	1598105	4x2 AIR						
O/O	40016	1609002	O/I	40013	1605163			6x2 Drive Axle AIR	
			O/I	40013	1605163			6x4 AIR	
			O/O	M85046 M89434	8026658			6x4 USA AIR	
			O/I	40111	1629483			6x4, 8x4 8 Bag AIR	
			O/I	40013	1605163			6x4 AIR	

SYMBOLS



AIR	Air Suspension	TAP	Tapered Leaf Suspension	SS	Spring Suspension	TBS	Torsion Bar Suspension
PSS	Parabolic Spring Suspension	AEON	AEON Spring	TLS	Trapezium Leaf Suspension		
MLS	Multi Leaf Suspension	RBS	Rubber Block Suspension	IFS	Independant Front Suspension		

1. Please see the Cross Reference section of this catalog for a complete list of OE references.

2. Part number marked in **Bold Italic** represent the Premium, adjustable, heavy duty gas shock absorbers.





www.meritorpartsonline.com

		FRONT				REAR			
		Mount	MERITOR	OE	REMARKS	Mount	MERITOR	OE	REMARKS

VOLVO										
FLE250 / FLH250										
		O/O	2774	3987959		AIR				
FM7 (4x2, 6x2, 6x4, 8x4)										
							I/I	40121	1629477	4x2 SS
							I/I	40121	1629477	6x2 Drive Axle SS
							O/I	2527	1612217 1629405 1629993	6x4, 8x4 SS
		O/O	2595	3171962 3171963 3987957 3987958 20374546 20374548			O/I	40111	1629482 1629484	4x2 RAD-A4 4 Bag AIR
							O/I	40111	1629483 1629484	6x2 6 Bag AIR
							O/O	50011	1598106	6x2 Trailing Axle 6 Bag AIR
							O/I	40111	1629483	6x4, 8x4 RADD-A8 8 Bag AIR
							O/O	40009	20374543 20585556 20766063 21232663	
FM9 (4x2, 6x4, 6x2, 8x4)										
		O/O	2595	3171962						
							O/I	2527	1612217	6x4, 8x4 SS
							O/I	40111	1629482 1629484	4x2 RAD-A4 4 Bag AIR
							O/I	40111	1629483	6x4, 8x4 RADD-A8 8 Bag AIR
							O/O	40009	20374543	

MOUNTING DIAGRAMS					
O/O	Top Eye (with sleeve) / Bottom Eye (with sleeve)	I/I	Top Pin/Stud / Bottom Pin/Stud	O/O	Top Eye / Bottom Eye
O/O	Top Eye (with sleeve) / Bottom Eye	I/O	Top Pin/Stud / Bottom Eye	O/I	Top Eye / Bottom Pin/Stud
O/I	Top Eye (with sleeve) / Bottom Pin/Stud	I/O	Top Pin/Stud / Bottom Eye (with sleeve)	O/O	Top Eye / Bottom Eye (with sleeve)

1. Please see the Cross Reference section of this catalog for a complete list of OE references.
2. Part number marked in ***Bold Italic*** represent the Premium, adjustable, heavy duty gas shock absorbers.

		FRONT				REAR			
		Mount	MERITOR	OE	REMARKS	Mount	MERITOR	OE	REMARKS

VOLVO

FM12 / FM13

						I/I	4344	1629477	4x2 SS
						I/I	4344	1629477	6x2 Drive Axle SS
						O/I	2527	1612217 1629405	6x4, 8x4 SS
						O/I	40111	1629482 1629484	4x2, RAD-A4 4 Bag AIR
						O/I	40111	1629483 1629484	6x2 Drive Axle 6 Bag AIR
						O/O	50011	1598106	6x2 Trailing Axle 6 Bag AIR
						O/I	40111	1629483 1629484	6x2 Drive Axle 8 Bag AIR
						O/O	40003	20374544 20401856 20585555	7"/180mm AIR
		O/O	2595	3171962 3171963 3987957 3987958 20374546 20374548		O/O	40009	20374543 20585556 20766063 21232663	9.5"/240mm AIR
						O/O	2774	3987959	Push Or Lift Axle 7"/180mm AIR
						O/O	2589	1628189 1629480 1691617	9.5"/240mm AIR
							2773	3987960	
						O/I	40111	1629483	6x4, 8x4 RADD-A8 8 Bag AIR
						O/O	40009	20374543 20585556 20766063 21232663	
						O/O	40003	20374544 20401856 20585555	

FM300, 340, 360, 380, 400, 440, 480 (4x2) (6x4) (8x4)

4x2, 6x4		O/O	2595	20374548					
8x4		O/O	4416	20374546	1st & 2nd Axle				

G88, G89

	66-	O/O	4047	362960					
	74-	O/O	4199	1591736					

N7

		O/O	4199	1591736					
--	--	-----	------	---------	--	--	--	--	--



SYMBOLS

AIR	Air Suspension	TAP	Tapered Leaf Suspension	SS	Spring Suspension	TBS	Torsion Bar Suspension
PSS	Parabolic Spring Suspension	AEON	AEON Spring	TLS	Trapezium Leaf Suspension		
MLS	Multi Leaf Suspension	RBS	Rubber Block Suspension	IFS	Independant Front Suspension		

1. Please see the Cross Reference section of this catalog for a complete list of OE references.

2. Part number marked in **Bold Italic** represent the Premium, adjustable, heavy duty gas shock absorbers.



		FRONT				REAR			
		Mount	MERITOR	OE	REMARKS	Mount	MERITOR	OE	REMARKS

VOLVO

N10 / N12

83-	O/O	4199	1568340 1591735 1608888		I/I	4319	8153538	4x2 SS
					O/I	2527	1612217 1629993	6x4 T&B RIDE SS
84-	O/O	40275	1609553 1609603		I/I	4319	8153538	4x2 SS
					O/I	2527	1612217 1629993	6x4 T&B RIDE SS

N86 / N88

	O/O	4047	362960					
--	-----	------	--------	--	--	--	--	--

NH12

96-	O/O	2595	3171962 3171963		O/I	2527	1612217	SS
						40120	1629405	
					O/I	40111	1629483	8 Bag AIR

NH16



	O/O	2595	1629992 3171962 3171963 3987957 3987958	PSS	I/I	40121	1629477	4x2, 6x2 Drive Axle SS
					O/I	2527	1612217	6x4, 8x4 SS
						40120	1629405	
					O/I	40111	1629482	CHH STD 4 Bag AIR
					O/I	2527	1612217	CHH 850 AIR
						40119	1629476	
					O/I	40111	1629484	CHH 900 AIR
O/I	40111	1629483 1629484	6x2 6 Bag AIR					
	O/O	2774	3987959	AIR	I/I	40121	1629477	4x2, 6x2 Drive Axle SS
					O/I	2527	1612217	6x4, 8x4 SS
						40120	1629405	
					O/I	40111	1629482	CHH STD 4 Bag AIR
					O/I	2527	1612217	CHH 850 AIR
						40119	1629476	
					O/I	40111	1629484	CHH 900 AIR
O/I	40111	1629483 1629484	6x2 6 Bag AIR					
O/I	40111	1629483	6x4, 8x4 RADD-A8 8 Bag AIR					

MOUNTING DIAGRAMS

O/O	Top Eye (with sleeve) / Bottom Eye (with sleeve)	I/I	Top Pin/Stud / Bottom Pin/Stud	O/O	Top Eye / Bottom Eye
O/O	Top Eye (with sleeve) / Bottom Eye	I/O	Top Pin/Stud / Bottom Eye	O/I	Top Eye / Bottom Pin/Stud
O/I	Top Eye (with sleeve) / Bottom Pin/Stud	I/O	Top Pin/Stud / Bottom Eye (with sleeve)	O/O	Top Eye / Bottom Eye (with sleeve)

1. Please see the Cross Reference section of this catalog for a complete list of OE references.
2. Part number marked in ***Bold Italic*** represent the Premium, adjustable, heavy duty gas shock absorbers.



		FRONT				REAR			
		Mount	MERITOR	OE	REMARKS	Mount	MERITOR	OE	REMARKS

VOLVO

NH565

6x4		O/O	2595	20374548					
3									
		O/O	4199	1568340		O/O	40275	1609553	W-RIDE SS
		O/O				O/I	2527	1612217	T&B RIDE SS
		O/O	40275	1609553		O/O	M85046 M89434	8026658	6x4 USA AIR
						O/O	M85024 M89416	8071524	

WESTERN STAR



		O/O	M85308 M89422	57252		O/O		CP5222 04-9041375	SS
		O/O	M83401	676081 676082	4 shocks per axle	O/I		57241-3 57241-003	Hendrickson HN402, HN462 RBS
		O/O	M85007 M89412		6900 series, F model	O/O		16-15770-000	Airliner Tuftrac AIR
				SL552/51	7900 series COE Commander	O/O		16-15817-000	Airliner FASII AIR
		O/O	M85053 M89442	37301-3401 37301-3403 37301-3404 37301-3405 37301-3409 37301-3412 37301-4401 37301-4402 37301-4403	Other models MLS or PSS	O/O		47902-024 57905-001 57905-002 60670-005	Hendrickson HAS400, HAS460, HAS461 AIR
	01-	O/O	M83144		5864 (NZ)	O/O		60675-003 60675-003L 60657-005 98583-032	Hendrickson PAX460 Primax AIR 8.5", 10" ride height
								60665-011	Hendrickson PAX460 Primax AIR 12.5", 14.375", 15.5" ride height

Rear Suspension options are available in any combination for all models listed above - Check OE number for application

SYMBOLS

AIR	Air Suspension	TAP	Tapered Leaf Suspension	SS	Spring Suspension	TBS	Torsion Bar Suspension
PSS	Parabolic Spring Suspension	AEON	AEON Spring	TLS	Trapezium Leaf Suspension		
MLS	Multi Leaf Suspension	RBS	Rubber Block Suspension	IFS	Independant Front Suspension		

1. Please see the Cross Reference section of this catalog for a complete list of OE references.
2. Part number marked in **Bold Italic** represent the Premium, adjustable, heavy duty gas shock absorbers.

		FRONT				REAR			
		Mount	MERITOR	OE	REMARKS	Mount	MERITOR	OE	REMARKS

WESTERN STAR

		O/O	M85308 M89422	57252		O/O		90044025	Neway ARDST AIR 8.5" ride height
		O/O	M83401 x 4	676081 676082	4 shocks per axle			90044968	
		O/O	M85007 M89412		6900 series, F model	O/O		90044025	Neway ARDST AIR 10" ride height
				SL552/51	7900 series COE Commander			90044968	
		O/O	M85053 M89442	37301-3401 37301-3403 37301-3404 37301-3405 37301-3409 37301-3412 37301-4401 37301-4402 37301-4403	Other models MLS or PSS	O/O		90045099	Neway ARD246 AIR 8.5" ride height
	01-	O/O	M83144		5864 (NZ)	O/O		9045132	Neway ARD246 AIR 10" ride height All models except Consellation
102AR						O/O	M85024 M89416	12887-01 19824-01	Reyco AIR

Rear Suspension options are available in any combination for all models listed above - Check OE number for application

WHITE

		O/O	M85308 M89422	5534430		O/O	M83204	494-660	
			M85304	570-S-5					
			M83401	5554959 37001-5	4 shocks per axle				
TF4638 (NZ)		I/I	2555		4 shocks per axle	O/O	M83204	494-660	

MOUNTING DIAGRAMS

O/O	Top Eye (with sleeve) / Bottom Eye (with sleeve)	I/I	Top Pin/Stud / Bottom Pin/Stud	O/O	Top Eye / Bottom Eye
O/O	Top Eye (with sleeve) / Bottom Eye	I/O	Top Pin/Stud / Bottom Eye	O/I	Top Eye / Bottom Pin/Stud
O/I	Top Eye (with sleeve) / Bottom Pin/Stud	I/O	Top Pin/Stud / Bottom Eye (with sleeve)	O/O	Top Eye / Bottom Eye (with sleeve)

1. Please see the Cross Reference section of this catalog for a complete list of OE references.
2. Part number marked in **Bold Italic** represent the Premium, adjustable, heavy duty gas shock absorbers.



TRAILER

BPW TRAILER	1
EVOTRAC	1
FAIRFAX (NZ)	1
FRANKLIN	1
FREIGHTER	1
FRUEHAUF	2
GRANNING	2
HALE NZ	2
HAULMARK	2
HENDRICKSON	2-7
HOCKNEY	7
HOLLAND	7
HUTCHENS (HUTCH NZ)	7
KRUEGER	7
MERITOR	7
NEWAY	8
REYCO	8
R.F.S	8
RIDEWELL	9
R.O.R	9-10
SAF	10
TMC	10
WEWELER	10
YORK	11





REAR

Mount	MERITOR	OE	REMARKS
-------	---------	----	---------

BPW TRAILER

		O/O	40006	02.3702.10.00 02.3702.17.00 02.3702.18.00 02.3702.60.00 02.3702.67.00 40-863-0 40-898-0 50-280-7	
		O/O	40024	02.3702.14.00 02.3702.19.00 02.3702.36.00 02.3702.52.00 02.3722.14.00 02.3722.83.00 40-897-0 50-897-0 50-191-2 50-191-6	

EVOTRAC (YORK TECAIR FB)

Tecair FB - X360 /X370 /U150

		O/O	M85004	61.610053 85004 728616	16mm mounts
--	--	-----	--------	------------------------------	-------------

Tecair FB - X400 /U190 inc. VRH

		O/O		61.610	
--	--	-----	--	--------	--

FAIRFAX (NZ)

IS13		O/O	40059		24mm x 55mm mounts
------	--	-----	-------	--	--------------------

FRANKLIN

		O/O	M83215	180-1589	
		I / I	M83318	180-427	

FREIGHTER

Mechanical Suspension



	85-92	O/O	M85024 M89416	728618 RT41006	
	92-	O/O	M85006 M89401	RT42006	

MOUNTING DIAGRAMS

O/O	Top Eye (with sleeve) / Bottom Eye (with sleeve)	I/I	Top Pin/Stud / Bottom Pin/Stud	O/O	Top Eye / Bottom Eye
O/O	Top Eye (with sleeve) / Bottom Eye	I/O	Top Pin/Stud / Bottom Eye	O/I	Top Eye / Bottom Pin/Stud
O/I	Top Eye (with sleeve) / Bottom Pin/Stud	I/O	Top Pin/Stud / Bottom Eye (with sleeve)	O/O	Top Eye / Bottom Eye (with sleeve)

1. Please see the Cross Reference section of this catalog for a complete list of OE references.
2. Part number marked in **Bold Italic** represent the Premium, adjustable, heavy duty gas shock absorbers.



		REAR		
		Mount	MERITOR	OE

FRUEHAUF

Mechanical Suspension

		O/O	M85304	UCA-01113	
		O/O	M83128	UCD-6216-1	
		O/O	M85300 M89419	UCE-1295-901	25mm mounts
		O/O	M85030 M89406	UCE-9399-1	
		O/O	M85305	5352858 UCA-5431	
		O/O		10490.50565.1	

Air Suspension

SA		O/O	M85323 M89436	MD15236	
TA (NZ) (France Built)		O/O	M85300 M89419	UJ-B0177-001	
NT (NZ) (USA Built)		O/O	M85321	UCF-008339-01 UCF-008339-02	

GRANNING

		O/O	M85300 M89419	X2690 680162	
--	--	-----	-------------------------	-----------------	--

HALE NZ

		O/O	M83207 M89407	88-1490	
--	--	-----	-------------------------	---------	--

HAULMARK

Steel Suspension

	89-	O/O	M85305 M89425	728609 85305	
	90-		M85308 M89422	728607 85308	

HENDRICKSON

AAT23K (AA230T) 10.5T Intraax

		O/O	M85323 M89436	A-20126	
			M85738	B-21553	XHD

AAL23K (AA230L) 10.5T Intraax

6.5", 7.5", 9" ride height		O/O	M85939	B-24579	
12" ride height		O/O	M85738	B-21553	

SYMBOLS

AIR	Air Suspension	TAP	Tapered Leaf Suspension	SS	Spring Suspension	TBS	Torsion Bar Suspension
PSS	Parabolic Spring Suspension	AEON	AEON Spring	TLS	Trapezium Leaf Suspension		
MLS	Multi Leaf Suspension	RBS	Rubber Block Suspension	IFS	Independant Front Suspension		

1. Please see the Cross Reference section of this catalog for a complete list of OE references.

2. Part number marked in **Bold Italic** represent the Premium, adjustable, heavy duty gas shock absorbers.



REAR

Mount	MERITOR	OE	REMARKS
-------	---------	----	---------

HENDRICKSON

AA230NT (AANT23K) 10.5T Intraax

Mount	MERITOR	OE	REMARKS
O/O	M85323 M89436	A-20126 A-20889	
	M85738	B-21553	
	M85939	B-24579	
	M85938	B-23743	

AA230L (AAL23K) 10.5T Intraax

6.5", 7.5", 9" ride height		O/O	M85939	B-24579	
12" ride height		O/O	M85738	B-21553 B-21699 B-24023 98583-004 98583-011 98583-011R2 90-2396SP1 91-2641SP1	

AA230NT (AANT23K) 10.5T Intraax

		O/O	M85323 M89436	A-20126 A-20889 B-23566	
			M85738	B-21553 B-21699 B-23361 B-24023 B-24125 98583-004 98583-011 98583-011R2 90-2396SP1 91-2641SP1	
			M85939	B-24579	
			M85938	B-23743	

Check OE number on shock absorber to confirm correct application

AAL25K (AA250L) 11.3T Intraax

6.5", 7.5", 9" ride height		O/O	M85939	B-24579	
12" ride height		O/O	M85738	B-21553 B-21699 B-23361 B-24023 B-24125 98583-004 98583-011 98583-011R2 90-2396SP1 91-2641SP1	

MOUNTING DIAGRAMS

O/O	Top Eye (with sleeve) / Bottom Eye (with sleeve)	I/I	Top Pin/Stud / Bottom Pin/Stud	O/O	Top Eye / Bottom Eye
O/O	Top Eye (with sleeve) / Bottom Eye	I/O	Top Pin/Stud / Bottom Eye	O/I	Top Eye / Bottom Pin/Stud
O/I	Top Eye (with sleeve) / Bottom Pin/Stud	I/O	Top Pin/Stud / Bottom Eye (with sleeve)	O/O	Top Eye / Bottom Eye (with sleeve)

1. Please see the Cross Reference section of this catalog for a complete list of OE references.
2. Part number marked in **Bold Italic** represent the Premium, adjustable, heavy duty gas shock absorbers.



		REAR		
		Mount	MERITOR	OE

HENDRICKSON

AAT25K (AA250T) 11.3T Intraax

			M85323 M89436	A-20126 A-20889 B-23566	
		⊙/⊙	M85738	B-21553 B-21699 B-23361 B-24023 B-24125 98583-004 98583-011 98583-011R2 90-2396SP1 91-2641SP1	
			M85939	B-24579	
			M85938	B-23743	

Check OE number on shock absorber to confirm correct application

AAL30K (AA300L) Intraax

		⊙/⊙	M89437	B-23316 B-25436	
--	--	-----	---------------	--------------------	--

AAEDL30K (AA300EDL) Intraax

		⊙/⊙	M89437	B-23316 B-25436	
--	--	-----	---------------	--------------------	--

AAT30K (AA300T) Intraax

		⊙/⊙	M85738	B-21553 B-24023	
--	--	-----	--------	--------------------	--

AAEDT30K (AA300EDT) Intraax

14" ride height		⊙/⊙	M85738	B-23361	Front of Axle
			M89437	B-23316 B-25436	Rear of Axle
15" ride height		⊙/⊙	M85338	B-25515	Front of Axle
			M89437	B-23316 B-25436	Rear of Axle
16" & 17" ride height		⊙/⊙	M85338	B-25515	Front of Axle
				B-25512	Rear of Axle

HKANT40K (HKA180)

		⊙/⊙	M85000 M89436	A-20002	
			M85323 M89436	B-23566 B-24088	
			M85738	B-24125	

Check OE number on shock absorber to confirm correct application

SYMBOLS

AIR	Air Suspension	TAP	Tapered Leaf Suspension	SS	Spring Suspension	TBS	Torsion Bar Suspension
PSS	Parabolic Spring Suspension	AEON	AEON Spring	TLS	Trapezium Leaf Suspension		
MLS	Multi Leaf Suspension	RBS	Rubber Block Suspension	IFS	Independant Front Suspension		

1. Please see the Cross Reference section of this catalog for a complete list of OE references.

2. Part number marked in **Bold Italic** represent the Premium, adjustable, heavy duty gas shock absorbers.



REAR

Mount	MERITOR	OE	REMARKS
-------	---------	----	---------

HENDRICKSON

HKAT46K (HKA200)

		O/O	M85323 M89436	A-20126 B-23566	
			M85738	B-24125	

HKAT50K (HKA250)

		O/O	M85000 M89436	A-20002	
			M85323 M89436	B-23566	
			M85738	B-24125	

HT190U

		O/O	M85029	A-2212	
			M85000 M89436	A-20001	
			M85323 M89436	A-20126	

HT230

		O/O	M85014	S-2160	Top mount style
--	--	-----	--------	--------	-----------------

HT230T 10.5T

		O/O	M85000 M89436	A-20002	
			M85323 M89436	A-20126 A-20889	
			M85738	B-21553 B-21699 98583-004 98583-011 98583-011R2 90-2396SP1 91-2641SP1	

HT250T 11.3T

		O/O	M85029	A-2212 A-20416	
--	--	-----	--------	-------------------	--

MOUNTING DIAGRAMS

O/O	Top Eye (with sleeve) / Bottom Eye (with sleeve)	I/I	Top Pin/Stud / Bottom Pin/Stud	O/O	Top Eye / Bottom Eye
O/O	Top Eye (with sleeve) / Bottom Eye	I/O	Top Pin/Stud / Bottom Eye	O/I	Top Eye / Bottom Pin/Stud
O/I	Top Eye (with sleeve) / Bottom Pin/Stud	I/O	Top Pin/Stud / Bottom Eye (with sleeve)	O/O	Top Eye / Bottom Eye (with sleeve)

1. Please see the Cross Reference section of this catalog for a complete list of OE references.
2. Part number marked in **Bold Italic** represent the Premium, adjustable, heavy duty gas shock absorbers.





REAR

Mount	MERITOR	OE	REMARKS
-------	---------	----	---------

HENDRICKSON

HT250U 11.3T

All Except 7.5"- 021, 9"- 020, 9"- 021 ride height	O/O	M85000 M89436	A-20002	
		M85323 M89436	A-20126 A-20889	
		M85738	B-21553 B-21699 98583-004 98583-011 98583-011R2 90-2396SP1 91-2641SP1	
7.5"- 021 ride height	O/O	M85000 M89436	A-1667	
9"- 020, 9"- 021 ride height	O/O	M85029	A-2212	

HT250UB 11.3T

6.5", 7.5", 9.5"- 522 ride height	O/O	M85738	B-24023	
-----------------------------------	-----	--------	---------	--

HT250S /US 11.3T

5.5", 6.5" ride height	O/O	M85939	B-21995 B-23744	
7.5", 9", 12", 14" ride height	O/O	M85938	B-21994 B-23743 91-2640 95853-010	

HT300T 13.6T

	O/O	M85323 M89436	A-20126 A-20889	
		M85738	B-21553 B-21699 98583-004 98583-011 98583-011R2 90-2396SP1 91-2641SP1	

HT300U 13.6T

7.5", 9" ride height	O/O	M85323 M89436	A-20126 A-20889	
		M85738	B-21553 B-21699 98583-004 98583-011 98583-011R2 90-2396SP1 91-2641SP1	

T6-062

5.5", 6.5" ride height	O/O	M85939	B-21995 B-23744	
7.5", 8", 12", 14" ride height	O/O	M85938	B-21994 B-23743 91-2640 95853-010	

SYMBOLS

AIR	Air Suspension	TAP	Tapered Leaf Suspension	SS	Spring Suspension	TBS	Torsion Bar Suspension
PSS	Parabolic Spring Suspension	AEON	AEON Spring	TLS	Trapezium Leaf Suspension		
MLS	Multi Leaf Suspension	RBS	Rubber Block Suspension	IFS	Independant Front Suspension		

1. Please see the Cross Reference section of this catalog for a complete list of OE references.

2. Part number marked in **Bold Italic** represent the Premium, adjustable, heavy duty gas shock absorbers.



www.meritorpartsonline.com



REAR

Mount	MERITOR	OE	REMARKS
-------	---------	----	---------

HENDRICKSON

T9-084 / T9-106

5.5", 6.5" ride height		O/O	M85939	B-21995 B-23744	
7.5", 8", 12", 14" ride height		O/O	M85938	B-21994 B-23743 91-2640 95853-010	

T15-172 / T17-174

		O/O	M85030 M89440	A-2218	
			M83144	A-20886	

T23-US-6

		O/O	M85030 M89440	A-2218	
--	--	-----	-------------------------	--------	--

HOCKNEY

Thomas Tanker		O/O	40024		
---------------	--	-----	-------	--	--

HOLLAND (ALSO REFER R.O.R)

E520		O/O	4272	2501192	
H041 Underslung, H042 Overslung, H134 Underslung, U514 Underslung, U524 Overslung, U534 Overslung		O/O	4272	212.15.742	
E510 Underslung, E520 Overslung, E530 Underslung		O/O	4272	212.15.742	

HUTCHENS (HUTCH NZ)

		O/O	M85000 M89436	9423-00	
		O/O	M85300 M89419	1138-0 1139-0	

KRUEGER

Air Suspension

R.F.S		O/O	4272	1-0280-50-902-0 90-2227	20mm mounts
			50106	91-2400	24mm mounts

MERITOR

CS9i Top/Low Mount Suspension



		O/O	21228930	21228930	top mount
		O/O	21228392	21228392	low mount

MOUNTING DIAGRAMS

O/O	Top Eye (with sleeve) / Bottom Eye (with sleeve)	I/I	Top Pin/Stud / Bottom Pin/Stud	O/O	Top Eye / Bottom Eye
O/O	Top Eye (with sleeve) / Bottom Eye	I/O	Top Pin/Stud / Bottom Eye	O/I	Top Eye / Bottom Pin/Stud
O/I	Top Eye (with sleeve) / Bottom Pin/Stud	I/O	Top Pin/Stud / Bottom Eye (with sleeve)	O/O	Top Eye / Bottom Eye (with sleeve)

1. Please see the Cross Reference section of this catalog for a complete list of OE references.
2. Part number marked in ***Bold Italic*** represent the Premium, adjustable, heavy duty gas shock absorbers.



		REAR			
		Mount	MERITOR	OE	REMARKS

NEWAY

AR45		○/○	M85000 M89436	90044162	
AR75 (-6, -9, -12)		○/○	M85030 M89406	90044626	
AR90 (-14, -15)		○/○	M83124 M89407	90044089	
AR92 (-12, -14)		○/○	M85000 M89436	90044992	
AR93 (-14, -16)		○/○	M85060	90044642 90045338	
AR95		○/○	M83125	90044625	
RL228 (-14, -15, -16)		○/○	M85060	90044642 90045338	
RL228 (-17)		○/○	M83124 M89407	90044089	

REYCO

Air Suspension

AR23 TU-15 Overslung - Pre RFS		○/○	M85323 M89436	23523-01 23553-01	
AR23 TU-15 Overslung - Post RFS		○/○		23523-01	
AR25 UU-7.5		○/○	M85323 M89436	23553-01	19mm mounts
				23553-01 702963-01	24mm mounts
AR86, AR86T		○/○	M85024 M89416	18165-01	
AR87-9, AR87-14		○/○	M85300 M89419	12885-01 12885-03	
AR240 (NZ)		○/○	M85030 M89440	20126-01	19mm mounts
		○/○	M85007 M89412		25mm mounts
Other OE applications		○/○	M85024 M89416	12887-01 18286-01	
			M85013	17146-01	
			M83204	20960-01	

R.F.S (ALSO REFER KRUEGER)

		○/○	4272	90-2227	
--	--	-----	------	---------	--

SYMBOLS

AIR	Air Suspension	TAP	Tapered Leaf Suspension	SS	Spring Suspension	TBS	Torsion Bar Suspension
PSS	Parabolic Spring Suspension	AEON	AEON Spring	TLS	Trapezium Leaf Suspension		
MLS	Multi Leaf Suspension	RBS	Rubber Block Suspension	IFS	Independant Front Suspension		

1. Please see the Cross Reference section of this catalog for a complete list of OE references.

2. Part number marked in **Bold Italic** represent the Premium, adjustable, heavy duty gas shock absorbers.



		REAR		
		Mount	MERITOR	OE

RIDEWELL

Monopivot 240					
Overslung		O/O	M85323 M89436 M85738	1250563B000 1270563B000	

RAR 221					
		O/O	M83207 M89407	1250789B000	

R.O.R

Flexair (Indair)					
		O/O	4272	21215607 21215742 21215751 21215807 21221306 90-2022 90-2227	20mm mounts
			50108	21208363 21216058 21224034	24mm mounts

FL9000 / FL9000L					
		O/O	4272	90-2022 90-2227	20mm mounts
		O/O	21224745	21222271 21224531 21224745 90-2210 90-2316 90-2368SP2	24mm mounts
			40006	90-2017	
			21224778	21224778	

FL9000M					
		O/O	21224745	21222271	

FL11000					
	-4/93	O/O	50108	21208363	
	4/93-	O/O	21224745	21222271	
		O/O	40006	90-2017	
		O/O	21224778	21224778	
			50126	21221348	



FL11000L					
		O/O	21224745	21222271	

FP11000					
		O/O	21226989	21226989	

MOUNTING DIAGRAMS

O/O	Top Eye (with sleeve) / Bottom Eye (with sleeve)	I/I	Top Pin/Stud / Bottom Pin/Stud	O/O	Top Eye / Bottom Eye
O/O	Top Eye (with sleeve) / Bottom Eye	I/O	Top Pin/Stud / Bottom Eye	O/I	Top Eye / Bottom Pin/Stud
O/I	Top Eye (with sleeve) / Bottom Pin/Stud	I/O	Top Pin/Stud / Bottom Eye (with sleeve)	O/O	Top Eye / Bottom Eye (with sleeve)

1. Please see the Cross Reference section of this catalog for a complete list of OE references.
2. Part number marked in **Bold Italic** represent the Premium, adjustable, heavy duty gas shock absorbers.

		REAR		
		Mount	MERITOR	OE

R.O.R					
FS230					
		O/O		21227751	
XL9000 Flexlite					
		O/O	21225104	90-2456 21225104	
SAF					
AR316 / AR413 / AR416 / EU416					
		O/O	50040	2.376.001.001 2.376.001.002 2.376.001.400 2.376.001.800	20mm mounts
EM311 / EM411					
		O/O	40059	2.376.002.700	24mm mounts
			40024	2.376.002.600 40 1700 123 247	
EO314 / EO414					
		O/O	40059	2.376.002.700	24mm mounts
			40024	2.376.002.600 40 1700 123 247	
EU416					
		O/O	50040	2.376.001.001 2.376.001.002 2.376.001.400 2.376.001.800	20mm mounts
TMC					
LMV					
Vertically mounted		O/O			20mm mounts
WEWELER					
FL041, FL131		O/O	4272	90-2022 90-2022SP 90-2227	
			50010	91-2227 91-2643	

SYMBOLS

AIR	Air Suspension	TAP	Tapered Leaf Suspension	SS	Spring Suspension	TBS	Torsion Bar Suspension
PSS	Parabolic Spring Suspension	AEON	AEON Spring	TLS	Trapezium Leaf Suspension		
MLS	Multi Leaf Suspension	RBS	Rubber Block Suspension	IFS	Independant Front Suspension		

1. Please see the Cross Reference section of this catalog for a complete list of OE references.

2. Part number marked in **Bold Italic** represent the Premium, adjustable, heavy duty gas shock absorbers.



REAR

Mount	MERITOR	OE	REMARKS
-------	---------	----	---------

YORK

TECAIR 1

		O/Ø	4415	61-506246 61.506717.01	
		O/O	40104	61.506717.02 40 1700 125 753	

TECAIR 2

		O/O		61.788	
--	--	-----	--	--------	--

TECAIR FB - X360 / X370 / U150

		O/O		61.610053 85004 728616	16mm mounts
--	--	-----	--	------------------------------	-------------

TECAIR FB - X400 / U190 inc. VRH

		O/O	M85003	85003 728603 61.61052	16mm mounts
--	--	-----	--------	-----------------------------	-------------

TECAIR FB3

		O/O		61.610442 91-2756	
--	--	-----	--	----------------------	--

MOUNTING DIAGRAMS

O/O	Top Eye (with sleeve) / Bottom Eye (with sleeve)	I/I	Top Pin/Stud / Bottom Pin/Stud	O/O	Top Eye / Bottom Eye
O/O	Top Eye (with sleeve) / Bottom Eye	I/O	Top Pin/Stud / Bottom Eye	O/I	Top Eye / Bottom Pin/Stud
O/I	Top Eye (with sleeve) / Bottom Pin/Stud	I/O	Top Pin/Stud / Bottom Eye (with sleeve)	O/O	Top Eye / Bottom Eye (with sleeve)

1. Please see the Cross Reference section of this catalog for a complete list of OE references.
2. Part number marked in ***Bold Italic*** represent the Premium, adjustable, heavy duty gas shock absorbers.





BUS

ANSAIR	1
ASIA	1
AUSTRAL DENNING	1
BEDFORD	1
BOVA	2
CSEPEL	2
DENNIS	2
FORD NZ	2
GMC	2
HINO	2-4
IKARUS	4
INTERNATIONAL	5
ISUZU	5-6
IVECO	6
KASSBOHRER	6
KIA	5
LEYLAND / DAF	6
MAN	7-8
MAZDA	9
MERCEDES	9-12
METRO RIDER (NZ)	12
MITSUBISHI	12-13
NISSAN	13
OPTAREZ NZ	14
RENAULT	14
SCANIA	14-15
SEDDON	15
SETRA NZ	16
SPARTON	16
TOYOTA	16
UD / NISSAN	17
VOLVO	17-18
ZONDA NZ	18

		FRONT				REAR			
		Mount	MERITOR	OE	REMARKS	Mount	MERITOR	OE	REMARKS

ANSAIR (ALSO REFER TO SCANIA)



ASIA									
AM 805		I/O	M63320						
AM 815 (Combi mini bus)		I/O	M63211	AA85034700		O/O	M85304	MD91282100A	
AMB 825 (Combi mini bus)						O/O	M85304	MD91282100A	
KM 828 (Cosmos)		O/O		AA81034700		O/O		AA81028700	
Other OE numbers		O/O	M85305 M89425	G01342100		O/O		D112823000	

AUSTRAL DENNING									
Double Deck	88-	O/O	45078	8.231.220.000 8.231.269.000		O/O	77003		inc. tag axle
Denflex Air		O/O	7188	32A02145 32A02317		O/O	7188	32A02145 32A02317	

BEDFORD									
BLP		I/I	M83318	2717604 67-0211		O/O		2681019 65-0450 8814773	
J2S (NZ)		I/I	56105	62-0900		O/O	M85012 M89413	65-0271 7136681 8814772 8821428	
PFK (NZ)	84	O/I	56157	62-8910 7142012		O/O	M85012 M89413	65-0271 7136681 8814772 8821428	
SB (NFM)	82-84	O/I	56157	62-8910 7142012		O/O	M85012 M89413	65-0271 7136681 8814772 8821428	
VAL	66-	O/O	M85012 M89413	65-0271 7136681		O/O		2681019 65-0450 8814773	
VAM	73-75	O/O		2681019 65-0450 8814773		O/O		2681019 65-0450 8814773	
	75-	I/I	M83318	2717604 67-0211		I/I	M83318	2717604 67-0211	
VAS		O/I	56157	62-8910 7142012		O/O	M85012 M89413	65-0271 7136681 8814772 8821428	
VAS NZ		O/O		2681019 65-0450 8814773		O/O		2681019 65-0450 8814773	
YMT	75-	I/O	76103	2717605 67-0600		I/I	M83318	2717604 67-0211	
YRT	76-	I/O	76103	2717605 67-0600		I/I	M83318	2717604 67-0211	

MOUNTING DIAGRAMS					
O/O	Top Eye (with sleeve) / Bottom Eye (with sleeve)	I/I	Top Pin/Stud / Bottom Pin/Stud	O/O	Top Eye / Bottom Eye
O/O	Top Eye (with sleeve) / Bottom Eye	I/O	Top Pin/Stud / Bottom Eye	O/I	Top Eye / Bottom Pin/Stud
O/I	Top Eye (with sleeve) / Bottom Pin/Stud	I/O	Top Pin/Stud / Bottom Eye (with sleeve)	O/O	Top Eye / Bottom Eye (with sleeve)

1. Please see the Cross Reference section of this catalog for a complete list of OE references.
2. Part number marked in **Bold Italic** represent the Premium, adjustable, heavy duty gas shock absorbers.

		FRONT				REAR			
		Mount	MERITOR	OE	REMARKS	Mount	MERITOR	OE	REMARKS

BOVA

FUTURA		I/I	2508			I/I	2508		
--------	--	-----	------	--	--	-----	------	--	--

CSEPEL

613-05		O/O		VG62-011501	AIR				
800	95-	I/I	40106	VG62-010905		I/I	40106	VG62-010905	
844-19, 844-31, 854-07		I/I	ZR7051B	62-010913		I/I	ZR7051B	62-010913	

DENNIS

DART SLF	95	I/I	76041	65-6274		I/I	76041		
JAVELIN (CX290 NZ)	00-	I/I	76041			I/I	76041		

FORD NZ

R Series

R1011, 1014, 1111, 1114		I/I	4428			O/O	M85305 M89425		
							M85304		tag axle

GMC

PD4107		I/O	M85711	3192416		I/O	M85711	3182842	
--------	--	-----	--------	---------	--	-----	--------	---------	--

HINO (FOR NZ MODELS ALSO REFER TO TRUCK SECTION)

AB 115A (NZ)		I/O	M63320			O/O	M63173		
AB2WGA (NZ)	92	I/O	M63320						
AC 140		I/O	M63211	48500-1510		O/O		48530-1510	19mm mounts
								48530-1500	19mm mounts
							M85304	48530-1080	25mm mounts
AK 176		O/O	M85305 M89425	48500-1690				48530-1660	
AM 100	76-82	I/O	M63211	48500-1160		O/O	M85304	48530-1080	
BC 144M		I/O	M63320	48500-1291		O/O	M85305 M89425	48530-1460	
BD 186F						O/O	M85305 M89425	48530-1250	
BD 186R						O/O	M85305 M89425	48530-1250	
BD 190F						O/O	M85305 M89425	48530-1250	
BG 300		I/O	76043	48500-2080	AIR	I/I	4428	48530-1691	
BT51 (NZ)						I/I	76034		
BX 340, BX 341		O/O	M85308 M89422	48500-1140		O/O	M85305 M89425	48530-1250	
BY 300		O/O	M85308 M89422	48500-1120		O/O	M85308 M89422	48530-1190	
BY 320		O/O	M85305 M89425	6071-4800-81		O/O		6-031-7707-02	

SYMBOLS



AIR	Air Suspension	TAP	Tapered Leaf Suspension	SS	Spring Suspension	TBS	Torsion Bar Suspension
PSS	Parabolic Spring Suspension	AEON	AEON Spring	TLS	Trapezium Leaf Suspension		
MLS	Multi Leaf Suspension	RBS	Rubber Block Suspension	IFS	Independant Front Suspension		

1. Please see the Cross Reference section of this catalog for a complete list of OE references.

2. Part number marked in **Bold Italic** represent the Premium, adjustable, heavy duty gas shock absorbers.



www.meritorpartsonline.com

		FRONT				REAR			
		Mount	MERITOR	OE	REMARKS	Mount	MERITOR	OE	REMARKS

HINO (FOR NZ MODELS ALSO REFER TO TRUCK SECTION)



CG 277		I/O	M85311 M89424	48500-1960	SS	O/O	M83215	48530-1770	
CH 160 (NZ)		O/O		48500-2010	AIR	O/O		48530-1950	
CH3HFAA (NZ)		O/O	M85304	48500-2020		O/O		48530-2070	
CM 277		I/O	76043	48500-1880 48500-2080	AIR	I/I	4428	48530-1691	
CN 275 (NZ)		I/O	76043	48500-1880	AIR	I/I	4428	48530-1691	
FD (Truck Chassis)						O/O	M85305 M89425	48530-1250	
FJ1JJA		O/O	M85304	48500-2030		O/O	M85308 M89422	48530-2000	
HU275B (NZ), HU276B (NZ)	87-	I/I	76041						
HT 2M (NZ)		O/O	2557	48500-1860	PSS				
HT 233B (NZ)		O/O	2557	48500-1860	PSS	O/O	M85305 M89425	48530-1721	
HT 235		O/O		48500-2190	PSS				
HT 235B (NZ) Blue Ribbon		O/O	2557	48500-1860		O/O	M85305 M89425	48530-1721	
HT2MAA (NZ)		I/O		48500-2200	3 leaf PSS				
HT3KMA (NZ)		O/O	2557						
HU2MMA (NZ)		O/O		48500-2130		I/I		48530-2111 48530-2120	
HU 233, HU 236	88	O/O	M85304		AIR	I/I	4428		
HU3KEA (NZ)		O/O				I/I	2555		
HV3KPA (NZ)	90	I/I	40106		AIR				
RB 115, RB 145, RB 145A, RB 145K (NZ)	95-	I/O	M63320 M63448	48500-1710 48500-2430		O/O	M63173	48530-1650	
RB1WGA (NZ), RB2WGA (NZ)		I/O	M63320	48500-1710		O/O	M63173	48530-1650	
RC 320		O/O		48500-1080	AIR	O/O	M85308 M89422	48530-1190 48530-1451	
RC 520		O/O	M85304	48500-1111		I/I	2555	48530-1451	
RG 197		O/O	M85305 M89425	48500-1690	MLS				
	91-	O/O	M85305 M89425	48500-1690	PSS	O/O	M83215	48530-1290	
		I/O	M85311 M89424	48500-1960					
RG 230	91-	O/O	M85305 M89425	48500-1170		O/O	M83215	48530-1290	
		O/O	M83144	60665-5 60665-005	Hendrickson AIR				

MOUNTING DIAGRAMS

O/O	Top Eye (with sleeve) / Bottom Eye (with sleeve)	I/I	Top Pin/Stud / Bottom Pin/Stud	O/O	Top Eye / Bottom Eye
O/O	Top Eye (with sleeve) / Bottom Eye	I/O	Top Pin/Stud / Bottom Eye	O/I	Top Eye / Bottom Pin/Stud
O/I	Top Eye (with sleeve) / Bottom Pin/Stud	I/O	Top Pin/Stud / Bottom Eye (with sleeve)	O/O	Top Eye / Bottom Eye (with sleeve)

1. Please see the Cross Reference section of this catalog for a complete list of OE references.
2. Part number marked in **Bold Italic** represent the Premium, adjustable, heavy duty gas shock absorbers.



		FRONT				REAR			
		Mount	MERITOR	OE	REMARKS	Mount	MERITOR	OE	REMARKS

HINO (FOR NZ MODELS ALSO REFER TO TRUCK SECTION)

RH160A Rainbow (NZ)	89	O/O	M85304	48500-2001	AIR	I/O		48530-1941	
RH4J	96	O/O	M85304		AIR				
RJ 170 (NZ)	84	O/O		48500-1080 48500-1490	MLS	O/O	M85308 M89422	48500-1340	
RJ 171 (NZ)	87-	O/O		48500-1892	PSS	O/O	M85308 M89422	48530-1531 48530-1800 48530-1812	
RJ 172A, RJ 172B (NZ)	84-	O/O		48500-1080 48500-1490	22mm mount MLS	O/O	M85308 M89422	48530-1531 48530-1800 48530-1812	
			M85304	48500-1111	25mm mount MLS				
RJ 172C (NZ)		O/O		48500-1892	PSS	O/O	M85308 M89422	48530-1531 48530-1800 48530-1812	
RJ3HGA (NZ)		O/O		48500-2020	PSS	O/O	M85308 M89422	48530-1812	
RJ3 (NZ) Rainbow	91-	O/O		48500-1080 48500-1490	MLS	O/O	M85308 M89422	48530-1531 48530-1800 48530-1812	
				48500-2020	PSS				
RK 172 (NZ), RK 176 (NZ)		O/O	M85305 M89425	48500-1690	MLS				
RK176 (NZ)		O/O	M85308 M89422	48500-1140	AIR	O/O	M85305 M89425	48530-1250	
RK 250		O/O	M83144 M85919	60665-5 60665-005	Hendrickson Parasteer	O/O	M85006	60998-001	Hendrickson Comfort AIR
RL 321		O/O		48500-1200					
RM 197					AIR	O/O	M85053 M89442		
RR 170B (NZ), RR 171C (NZ)	87-	O/O	M85304	48500-1870	AIR	O/O	M85053 M89442		
RR 172, RR 172BA (NZ)		O/O	M85304	48500-2020 48500-1111	AIR	O/O	M85308 M89442	48530-1531 48530-1800 48530-1812	
RR192 (NZ)		O/O	M85304	48500-2020	AIR	O/O	M85308 M89442	48530-1991	
RR2H (NZ)						O/O	M85053 M89442		
RU1JJC (NZ)		O/O	2557	48500-2100		I/I	76041	48530-2121	
RU607B (NZ)		O/O	2557		AIR	I/I	2508		
RU638	88-	O/O	2557	48500-2070		I/I	76041	48530-1711	
RV 145	95-	I/O	M63448						
RV 530, RV 730		I/I	2508	48500-1451					

IKARUS (CUMMINS)

		I/I	40106			I/I	40106		
--	--	-----	-------	--	--	-----	-------	--	--

SYMBOLS



AIR	Air Suspension	TAP	Tapered Leaf Suspension	SS	Spring Suspension	TBS	Torsion Bar Suspension
PSS	Parabolic Spring Suspension	AEON	AEON Spring	TLS	Trapezium Leaf Suspension		
MLS	Multi Leaf Suspension	RBS	Rubber Block Suspension	IFS	Independant Front Suspension		

1. Please see the Cross Reference section of this catalog for a complete list of OE references.

2. Part number marked in **Bold Italic** represent the Premium, adjustable, heavy duty gas shock absorbers.



www.meritorpartsonline.com

		FRONT				REAR			
		Mount	MERITOR	OE	REMARKS	Mount	MERITOR	OE	REMARKS

INTERNATIONAL (METROTEC)

16.210 16.250		O/O		3266635R2		O/O	M83209 M89414	3264773R1	
17.210 (Delta)		O/O		3266635R2		O/O	M83209 M89414	3264773R1	Neway AD123-6
17.215 (Ultra low Floor)				98583-013	Hendrickson 5 Link AIR	O/O	M85030 M89406	A-4084	Hendrickson BRA230
17.250 (Delta)		O/O		3266635R2		O/O	M83209 M89414	3267863R1	Neway AD123-6
1830 ACCO		O/O	M83215	3017405R91 3252648R91		O/O		3247919R91	

ISUZU (FOR NZ MODELS ALSO REFER TRUCK SECTION)



BD	74	O/O	M85304	9-51630286-0 9-51630374-0		I/I	2555	9-51630370-0 9-51630388-0	
BE22 Journey		I/O	M63448	9-51630647-1		O/O	M63178	9-51630661-0	
BL35, 36 (NZ) Journey	87-	I/O	M63448	9-51630647-1		O/O	M63178	9-51630661-0	
CDM410 (NZ)		I/O	M63322	1-51630093-0		I/I	M83318	1-51630094-0	
CLM (NZ)		O/O	M85304	1-51630076-0		O/O		1-51630077-0	
CVR	89	I/O	76103	1-51630053-0 1-51630053-1 1-51630053-2					
CXG Twin Steer		O/O	M85304	1-51630131-0	1st axle				
		I/O	76103	1-51630053-0	2nd axle				
ECR570	85	I/O	76043	1-51630020-0		I/I	76034	9-51630387-0	
EXR	89	I/O	76103	1-51630053-0 1-51630053-1 1-51630053-2					
JCR500		I/O	76043	1-51630020-0		I/I	2555		
KB (NZ)	72-12/96	I/O	69992	9-51630659-0 9-51630674-1 9-51630674-2		O/O	M63178	9-51630660-0 9-51630675-1	
	1/77-	I/O	69992	9-51630659-3 9-51630674-2		O/O	M63173	5-51630018-2 5-51630019-1 5-51630046-1 5-51630047-1	
KS32 (NZ)	06/84	I/O	M63448	9-51630647-0 9-51630647-1		O/O	M85012 M89413	5-51630062-0 5-51630300-0 9-51630666-0	
LR211J, LR212J (NZ)		O/I		1-51630123-0	AIR	I/I	M85310 M89423		
LR312 (NZ) Journey	84	I/O	M63322	1-51630093-0		O/I		1-51630123-0	
						I/I	M85310 M89423		
LR332F (NZ)		I/O	M63448	1-51630372-0					
			M63322	1-51630259-0					
LR333 (NZ) 9mtr		O/I	M83112	1-51630493-0					

MOUNTING DIAGRAMS

O/O	Top Eye (with sleeve) / Bottom Eye (with sleeve)	I/I	Top Pin/Stud / Bottom Pin/Stud	O/O	Top Eye / Bottom Eye
O/O	Top Eye (with sleeve) / Bottom Eye	I/O	Top Pin/Stud / Bottom Eye	O/I	Top Eye / Bottom Pin/Stud
O/I	Top Eye (with sleeve) / Bottom Pin/Stud	I/O	Top Pin/Stud / Bottom Eye (with sleeve)	O/O	Top Eye / Bottom Eye (with sleeve)

1. Please see the Cross Reference section of this catalog for a complete list of OE references.
2. Part number marked in **Bold Italic** represent the Premium, adjustable, heavy duty gas shock absorbers.



		FRONT				REAR			
		Mount	MERITOR	OE	REMARKS	Mount	MERITOR	OE	REMARKS

ISUZU (FOR NZ MODELS ALSO REFER TRUCK SECTION)

LT111		I/O	76103	1-51630288-1		I/I		1-51630195-1	
LT112		I/O	76103	1-51630171-0 1-51630171-1					
LT312J (NZ)	86	O/O	M85304						
LV314K (NZ)		O/O	M85304	1-51630079-0		O/O		1-51630077-0	
LV324L, LV324N		O/O	M85304	1-51630275-2		O/O		1-51630269-0 1-51630454-0	
MT111 (NZ)		O/O	76103						
NPS400 (NPS59L) (NZ) 4WD BUS						O/O	M85012 M89413		

IVECO

Daily

35S13		O/O		504051655 504051656 504051658 504110593 504118348				504064549 5041071055 504118330	
50C13, 50C15		O/O		500369632 504043717 504043883 908323089		O/O		500369633 500398555 504043718 504043880 504043884 908323090	AIR

KASSBOHRER

Setra		O/O	2555	8.231.116.000		I/I	2555	8.231.346.000	inc. tag axle
-------	--	-----	------	---------------	--	-----	------	---------------	---------------

KIA (ALSO REFER ASIA BUS)

AMB 825 (Combi mini bus)						O/O	M85304		
KM 828 (Cosmos)		O/O		AA81034700		O/O		AA81028700	

LEYLAND / DAF

AEC 691, RELIANCE (NZ)	54-65	I/I	4428	5057-104					
AEC SWIFT		I/O	76043			I/O	M85311		
HIPPO (NZ)	66-	I/I	2508						
LEOPARD	66-	I/I	M85310 M89423	10897034		I/I	M85310 M89423	10897033	
NATIONAL	72-73	I/I	4249	10901454 10901511		I/I	4344	10901032	
PANTHER	66-70	I/I	M85310 M89423	10897034	AIR	I/I	M85310 M89423	10897033	
TIGER	80-	I/I	4249	HLK1873 HLK2161	AIR	I/I	40106	HLK1897	
						O/O	M85024 M89416		tag axle
		I/I	40106	04982103	SS	I/I	40106	10922248	

SYMBOLS



AIR	Air Suspension	TAP	Tapered Leaf Suspension	SS	Spring Suspension	TBS	Torsion Bar Suspension
PSS	Parabolic Spring Suspension	AEON	AEON Spring	TLS	Trapezium Leaf Suspension		
MLS	Multi Leaf Suspension	RBS	Rubber Block Suspension	IFS	Independant Front Suspension		

1. Please see the Cross Reference section of this catalog for a complete list of OE references.

2. Part number marked in **Bold Italic** represent the Premium, adjustable, heavy duty gas shock absorbers.



www.meritorpartsonline.com



		FRONT				REAR			
		Mount	MERITOR	OE	REMARKS	Mount	MERITOR	OE	REMARKS

MAN									
8.160 F	97	I/I	7175	81.43701.6821					
10.136		I/I	76041	81.43701.6716					
10.150, 10.155 HOCL	95	I/I	76041	81.43701.6716					
10.160	97-	I/I	7175	81.43701.6821		○/○	2722	81.43701.6610	
10.180		I/I	76041	81.43701.6716					
10.220 FOCL-R		I/I	76041	81.43701.6716					
			7175	81.43701.6821					
11.153		I/I	7175	81.43701.6789					
11.190 HOCL		I/I	76041	81.43701.6643		○/○	2722	81.43701.6610	
				81.43701.6716		○/○	40164	81.43701.6790	
11.220		I/I	76041	81.43701.6716		○/○	2722	81.43701.6610	
11.230 HOCL (NZ)	94-		76041	81.43701.6716		○/○	2722	81.43701.6610	
12.180						○/○	2722	81.43701.6610	
12.220 HOCL-R		I/I	76041						
12.223 (Truck Chassis)		I/I	7175	81.43701.6781 81.43701.6789		○/○	2723	81.43701.6782	
			I/O	7243	81.43701.6804				
14.190 HOCL		I/I	76041	81.43701.6716					
14.230 HOCL		I/I	76041	81.43701.6716		○/○	40164	81.43701.6790	
16.200		○/○	4343	81.43701.6405 81.43701.6418					
16.220, 16.230	94-	I/I	76041	81.43701.6716					
16.240	96-	○/○		81.43701.6249	SS		2555	81.43701.6428	
			7188	81.43701.6426					
16.240 HOCLN		○/○	4343	81.43701.6405 81.43701.6418	AIR	○/○	4342	81.43701.6177	inc. tag axle
16.280 HOCLN		○/○	4343	81.43701.6364 81.43701.6405 81.43701.6418	AIR	○/○	4342	81.43701.6177 81.43701.6406 81.43701.6419	inc. tag axle
16.290 HOCL	95-	○/○	4343	81.43701.6418		○/○	4342	81.43701.6177 81.43701.6406 81.43701.6419	inc. tag axle
18.220 HOCL		I/O	7243	81.43701.6751	PSS	I/I	4344	81.43701.6619	
18.232 HOCL		I/I	76041	81.43701.6716		I/I	2728	81.43701.6706	
18.250 NL	99-					I/I	2728	81.43701.6706	
18.280 HOCL-R, HOCL-R-NL	02-	I/I	4347	81.43701.6880					
18.310 HOCL	95-	I/I	76041	81.43701.6705 81.43701.6716 81.43701.6767		I/I	2728	81.43701.6706	
18.350 HOCLN	99-	I/I	76041	81.43701.6705		I/I	2728	81.43701.6706	
18.370 HOCL-R	95-	I/I	76041	81.43701.6705 81.43701.6716 81.43701.6767		I/I	2728	81.43701.6706	

MOUNTING DIAGRAMS					
○/○	Top Eye (with sleeve) / Bottom Eye (with sleeve)	I/I	Top Pin/Stud / Bottom Pin/Stud	○/○	Top Eye / Bottom Eye
○/○	Top Eye (with sleeve) / Bottom Eye	I/O	Top Pin/Stud / Bottom Eye	○/I	Top Eye / Bottom Pin/Stud
○/I	Top Eye (with sleeve) / Bottom Pin/Stud	I/O	Top Pin/Stud / Bottom Eye (with sleeve)	○/○	Top Eye / Bottom Eye (with sleeve)

1. Please see the Cross Reference section of this catalog for a complete list of OE references.
2. Part number marked in **Italic** represent the Premium, adjustable, heavy duty gas shock absorbers.



		FRONT				REAR			
		Mount	MERITOR	OE	REMARKS	Mount	MERITOR	OE	REMARKS

MAN									
22.280 HOCLR		O/Ø	4343	81.43701.6364 81.43701.6405 81.43701.6418		O/Ø	4342	81.43701.6177 81.43701.6406 81.43701.6419	inc. tag axle
22.320						O/Ø	4342	81.43701.6187 81.43701.6406 81.43701.6419	inc. tag axle
22.360 HIGH DECK		O/Ø	4343			O/Ø	4342	81.43701.6187 81.43701.6406 81.43701.6419	inc. tag axle
22.360 (NZ)		I/I	76041	81.43701.6729		O/Ø	4342	81.43701.6177 81.43701.6406 81.43701.6419	
22.372 HOCLN HI DECK	95-	O/Ø	4343	81.43701.6364 81.43701.6405 81.43701.6418		O/Ø	4342	81.43701.6177 81.43701.6406 81.43701.6419	inc. tag axle
24.400 HOCLN	99-	I/I	76041	81.43701.6729		O/Ø	4342	81.43701.6177 81.43701.6406 81.43701.6419	
24.420 HOCLN	95-	I/I	76041	81.43701.6729	IFS	I/I	2728 76041	81.43701.6706 81.43701.8787	tag axle
26.280		I/I	76041	81.43701.6572		I/I	4428	81.43701.6334 81.43701.6574	
26.320						O/Ø	4342	81.43701.6177 81.43701.6406 81.43701.6419	
NL202, NL202 H		I/I	76041	81.43701.6713 81.43701.6729		I/I	2728	81.43701.6706 81.43701.6714 81.43701.6760 81.43701.6768	
SG280 ARTICULATED		I/I	76041	81.43701.6572		I/I	4428	81.43701.6334 81.43701.6574	
SL200 MK1		I/I	76041	81.43701.6409 81.43701.6572 81.43701.6607		I/I	4428	81.43701.6195 81.43701.6528	
SL200 MK2 VOV 2		I/I	76041	81.43701.6409 81.43701.6705 81.43701.6572 81.43701.6607		I/I	4428	81.43701.6334 81.43701.6572 81.43701.6578 81.43701.6195 81.43701.6528	
SL202		I/I	76041	81.43701.6409 81.43701.6705 81.43701.6572 81.43701.6607		I/I	4428	81.43701.6334 81.43701.6572 81.43701.6578 81.43701.6195 81.43701.6528	
SL252		I/I	76041	81.43701.6705		I/I	2728	81.43701.6706	

SYMBOLS

AIR	Air Suspension	TAP	Tapered Leaf Suspension	SS	Spring Suspension	TBS	Torsion Bar Suspension
PSS	Parabolic Spring Suspension	AEON	AEON Spring	TLS	Trapezium Leaf Suspension		
MLS	Multi Leaf Suspension	RBS	Rubber Block Suspension	IFS	Independant Front Suspension		

1. Please see the Cross Reference section of this catalog for a complete list of OE references.

2. Part number marked in **Bold Italic** represent the Premium, adjustable, heavy duty gas shock absorbers.



www.meritorpartsonline.com



		FRONT				REAR			
		Mount	MERITOR	OE	REMARKS	Mount	MERITOR	OE	REMARKS

MAZDA									
T3500						O/O	M63299		
MERCEDES									
701 (NZ)	78	I/I	2508						
701DA (NZ)	96	O/O	2219			O/O	2219		
811D	95-	O/O	7128	004 323 8900 005 323 0900 688 323 7000		O/O	2219	004 326 1300 004 326 6700	
814D	95-	O/O	7128	004 323 8900 005 323 0900 688 323 7000	Chassis 670 313	O/O	2219	004 326 1300 004 326 6700	
911 L, 911 LK, 911 LP	61-	O/O	76039	000 323 9700					
911 (B) L, 911 (B) LF, 911 (B) LK, 911 (B) LKO, 911 (B) LS (CH 353)	61-	O/O	76019	004 323 7400		O/O	76104	345 326 7500	
911 (B) LA, 911 (B) LAK, 911 (B) LAKO (CH 353)	61-	O/O	2444	004 323 6200		O/O	76104	345 326 7500	
L709B		O/O		688 323 0100		O/O		688 323 0100	
LO 812 (B)	91-	O/O	7128	688 323 7000		O/O	7128	688 326 7000	
LO 814 VARIO	96	O/O	7128	688 323 7000		O/O	7128	688 326 7000	
LO 912	90	O/O	7128	688 323 7000		O/O	7128	688 326 7000	
0 302		I/I	2508	302 323 0200 302 323 0300 307 326 0300		I/I	2508	302 323 0200 302 323 0300 307 326 0300	
		Θ/O		000 463 0200 000 463 6232	steering damper				
		O/O	1826	000 240 2348 301 240 0048	engine damper				
0 303		I/I	2508	002 326 2300 003 326 3400 003 326 7500 307 326 0200 307 326 0300		I/I	2508	002 326 2300 003 326 7500 004 326 2800 307 326 0200 307 326 0300 357 326 0000	
		Θ/O		000 463 0200 000 463 6232 000 463 6432 364 460 7466	steering damper				
		O/O	1826	000 240 2348 301 240 0048	engine damper				

MOUNTING DIAGRAMS					
O/O	Top Eye (with sleeve) / Bottom Eye (with sleeve)	I/I	Top Pin/Stud / Bottom Pin/Stud	O/O	Top Eye / Bottom Eye
O/O	Top Eye (with sleeve) / Bottom Eye	I/O	Top Pin/Stud / Bottom Eye	O/I	Top Eye / Bottom Pin/Stud
O/I	Top Eye (with sleeve) / Bottom Pin/Stud	I/O	Top Pin/Stud / Bottom Eye (with sleeve)	O/O	Top Eye / Bottom Eye (with sleeve)

1. Please see the Cross Reference section of this catalog for a complete list of OE references.
2. Part number marked in ***Bold Italic*** represent the Premium, adjustable, heavy duty gas shock absorbers.



		FRONT				REAR			
		Mount	MERITOR	OE	REMARKS	Mount	MERITOR	OE	REMARKS

MERCEDES

0 305, 0 307		I/I	2508	002 326 2300 003 326 7500 307 326 0200 307 326 0300 357 326 0100	steering damper	I/I	2508	002 326 4000 003 326 7500 004 326 2800 307 326 0200 307 326 0300 357 326 0000	inc. tag axle
		Θ/O		000 463 0200 000 463 6232 000 463 6432 364 460 7466					
		O/O	1826	000 240 2348 301 240 0048					
0 400 UP (CH 664 206)		I/I	2508	307 326 0300 364 326 7200	steering damper	I/I	2508	002 326 4000 307 326 0300 364 326 7200	
		Θ/O		364 460 7466					
		O/O	1826	664 240 7048					
0 404 (2 & 3 Axle Coach)		O/O	40149	356 323 0200 356 323 0500		I/I	2555	005 326 3500 005 320 0031	
0 405 (Brazil) (CH357 001/005/011)		I/I	2508	307 326 0200 307 326 0300	steering damper	I/I	2508	307 326 0300 357 320 0131	
		Θ/O		000 463 0200 000 463 6232 000 463 6432 364 460 7466					
0 405 NH CNG (Low Floor)		I/I	4428	357 323 0600		I/I	4428	004 326 2800 357 326 0300	
0 500LE (Low Entry)	02-			628 323 0200		I/I	2555	356 320 0031 356 326 0700	
0 500F 2 (2 Axle Chassis)	02					I/I	2555	356 320 0031 356 326 0700	
0 500RF 3 (3 Axle Chassis)	02			629 323 0000		I/I	2555	356 320 0031 356 326 0700	
0C 1617		O/O	76036	003 323 3700		O/O	2444	002 326 9600 003 326 4900	Chassis ~ 4 724073
								004 326 0300	Chassis 4 724074 ~
0C 1621		O/O	76036	003 323 3700	Chassis ~ 4 820299	O/O	2444	004 326 0300	
			76109	003 323 8500	Chassis 4 820300 ~				
0F 1113		O/O	76036	001 323 6500 003 323 3700		O/O	76104	002 326 9800	
			76109	003 323 8500					
0F 1113B		O/O	76109	003 323 8500		O/O	2444	004 323 4400 006 323 0700	Chassis 4 134171 ~ 4 251091

SYMBOLS



AIR	Air Suspension	TAP	Tapered Leaf Suspension	SS	Spring Suspension	TBS	Torsion Bar Suspension
PSS	Parabolic Spring Suspension	AEON	AEON Spring	TLS	Trapezium Leaf Suspension		
MLS	Multi Leaf Suspension	RBS	Rubber Block Suspension	IFS	Independant Front Suspension		

1. Please see the Cross Reference section of this catalog for a complete list of OE references.

2. Part number marked in **Bold Italic** represent the Premium, adjustable, heavy duty gas shock absorbers.



www.meritorpartsonline.com



		FRONT				REAR			
		Mount	MERITOR	OE	REMARKS	Mount	MERITOR	OE	REMARKS

MERCEDES									
0F 1315 (CH384 098)		○/○		345 323 7200		○/○		384 326 7400	
0F 1317 (CH352 088/089)		○/○	76036	003 323 9600		○/○	76104	001 326 7500	
0F 1413 (CH352 067)		○/○	76036	003 323 9600		○/○	76104	001 326 7500	
0F 1417 (CH352 067)		○/○	76036	003 323 9600		○/○	76104	001 326 7500	
0F 1617		○/○	76036	001 323 6500 003 323 3700 003 323 9600		○/○	76104	001 326 7500 002 326 9800	Chassis ~ 4 134170
							2444	004 326 0300	Chassis 4 134171 ~ 4 251091
							76104	001 326 7500 002 326 9800	Chassis 4 239919 ~ 4 476883
0H 1316, 0H 1318		○/○		345 323 7200 345 323 7300 384 323 7300		○/○		345 326 7000 345 326 7600 386 326 7000	
0H 1411		○/○		345 323 7200 345 323 7300		○/○		345 326 7000	
0H 1416, 0H 1417		○/○	76022	004 323 8500 004 323 8600				004 326 0500	
		I/I	2508	307 323 0200	(Ch396 356/476)				
0H 1418		○/○		345 323 7200 345 323 7300		○/○		345 326 7000	
0H 1425		○/○	76022	004 323 8600	AIR				
0H 1617		○/○	76036	003 323 3700 003 323 9600		○/○	76104	003 326 4900	Chassis ~ 4 724073
								001 326 7500 002 326 0900	Chassis 4 724074 ~
0H 1621		○/○	76036	003 323 3700 003 323 9600	Chassis ~ 4 820299 SS	○/○	2444	004 326 0300	Chassis ~ 4 820300
			76109	003 323 8400 003 323 8500	Chassis ~ 4 820299 SS				
0H 1621L (inc. Educator)		○/○		382 323 7300 382 323 7400	AIR	○/I		382 326 7300	
0H 1622		○/○	76022	004 323 8500 004 323 8600	(Ch396356/376) SS			004 326 0500	
		I/I	2508	307 323 0200	(CH396456/476) SS				
0H 1622L		I/I	2508	307 323 0200 307 326 0300	(CH396 356/376) Chassis ~ 5 471367 AIR	I/I	2508	307 326 0300 357 320 0131	
				396 320 0030	(CH396 356/376) Chassis 5 471368 ~ AIR				
				003 323 4700	(CH396 356/376) Chassis ~ 5 471368 AIR				

MOUNTING DIAGRAMS					
○/○	Top Eye (with sleeve) / Bottom Eye (with sleeve)	I/I	Top Pin/Stud / Bottom Pin/Stud	○/○	Top Eye / Bottom Eye
○/○	Top Eye (with sleeve) / Bottom Eye	I/O	Top Pin/Stud / Bottom Eye	○/I	Top Eye / Bottom Pin/Stud
○/I	Top Eye (with sleeve) / Bottom Pin/Stud	I/○	Top Pin/Stud / Bottom Eye (with sleeve)	○/○	Top Eye / Bottom Eye (with sleeve)

1. Please see the Cross Reference section of this catalog for a complete list of OE references.
2. Part number marked in ***Bold Italic*** represent the Premium, adjustable, heavy duty gas shock absorbers.



		FRONT				REAR			
		Mount	MERITOR	OE	REMARKS	Mount	MERITOR	OE	REMARKS

MERCEDES

OH 1625		O/O	76022	004 323 8500	(Ch396 356/376) SS			004 326 0500	
		I/I	2508	307 323 0200	(Ch396 356/376) SS				
OH 1625L		I/I	2508	307 323 0200	(CH396 356/376) Chassis ~ 5 4741367 AIR	I/I	2508	307 326 0300	
	396 320 0030			(CH396 356/376) Chassis 5 471368 ~ AIR					
	003 323 4700			(CH396 356/376) Chassis ~ 690143 AIR	I/I	2508	004 326 2800		
OH 1628	99-	O/O	76022	004 323 8500 004 323 8600				004 326 0500	
		I/I	2508	307 323 0200					
OH 1628L		I/I	2508	003 323 4700 307 323 0200		I/I	2508	004 326 2800	
OH 1630L	96-	O/O		382 323 7300 382 323 7400	AIR	O/I		382 326 7300	
OH 1634L		I/I	4428	304 700 6497	AIR				
OH 1725 (inc.Educator)		I/I	2508	634 323 0100	AIR				
OHL 1418		O/O		345 326 7000	AIR	I/I	2508	364 326 7200	
OHL 1421L		O/O	M83101	382 323 7400	AIR	O/I		382 326 7300	

METRO RIDER (NZ)

MCW	88-89					I/I	2508		
-----	-------	--	--	--	--	-----	------	--	--

MITSUBISHI (& FUSO NZ)

BE211D ROSA (NZ) (4 Cyl)	83					O/O	M63178	MA222515	
BE435E (NZ) BE435F (NZ)	89-	I/O	M63320	MC357243		O/O	M63299	MC357241	
BE437F ROSA (NZ)						O/O	M63299	MC352586	
BE449 ROSA (NZ)		I/O	M63320						
BE649 ROSA		I/O	M63211	MC189093	IFS				
BK215 ROSA (NZ) (6 Cyl)	81	I/O	M63320			O/O	M63299		
MFB649 ROSA	99	I/O	M63320	MC189093 MK469020	IFS	O/O	M63178	MC189924	
MJ117F (NZ)	93	O/O	M85304	MC806993		O/O	4199	MC808521	
MJ527F (NZ)		O/O	M85304		AIR				
MK113 (NZ)		O/O		MC808057		O/O		MC808058	
MK116F, MK116J FUSO		O/O	M85304	MC806993	MLS	O/O	4199	MC808521	
			2557	MC816002	PSS			03260-82005 MC816093	

SYMBOLS

AIR	Air Suspension	TAP	Tapered Leaf Suspension	SS	Spring Suspension	TBS	Torsion Bar Suspension
PSS	Parabolic Spring Suspension	AEON	AEON Spring	TLS	Trapezium Leaf Suspension		
MLS	Multi Leaf Suspension	RBS	Rubber Block Suspension	IFS	Independant Front Suspension		

1. Please see the Cross Reference section of this catalog for a complete list of OE references.
2. Part number marked in **Bold Italic** represent the Premium, adjustable, heavy duty gas shock absorbers.



		FRONT				REAR			
		Mount	MERITOR	OE	REMARKS	Mount	MERITOR	OE	REMARKS

MITSUBISHI (& FUSO NZ)

MK117J FUSO (NZ)	85-	O/O	M85304 2557	MC806993 MC816002	MLS PSS	O/O	4199	MC808521	
MK126F (NZ)						O/O	4199	MC808521	
MK126 (NZ)		O/O	M85304	MC806993	PSS	O/O	4199	MC808521	
MK218J (NZ)		O/O	M85304	MC806993	PSS	O/O	4199	MC808521	
MK219J (NZ)	96	O/O	M85304	MC806993 MC808753		O/O	4199	MC808521	
MK516J FUSO (NZ)	84-	O/O		MC811903	AIR	O/O		MC811903	
MK517F, MK517J (NZ)		O/O		MC811903	AIR				
MM116H (NZ)		O/O	M85304	MC806993	MLS				
MM1175 (NZ)	90	O/O		MC816788	PSS				
MM515 (NZ)		O/O		MC816788	AIR	O/I		MC806840	
MM517J (NZ)		I/O	76041		AIR				
MM527H (NZ)	88-	O/O		MC816788		O/I		MC806840	
						O/O		MC816788	tag axle
MP218K (NZ)		O/O		MC816788	MLS	O/O		MC808058	
MP218M		O/O		MC808057	AIR				
MP218N		O/O		MC816788	MLS	O/O		MC808058	
MP618M (NZ)		I/I	2555 2508		AIR	O/I		MC806840	
MR112F (NZ)		O/O	M63299						
MS715, MS725		O/O		MC816788	AIR	O/I		MC806840	
						O/O	M85323 M89436		tag axle
MU525T (NZ)		O/O		MC816788	AIR	O/I		MC806840	
						O/O		MC816788	tag axle
VOLGREN	96-	I/O	M63320			O/O	M85030 M89406		

NISSAN (ALSO REFER UD)



W40 CIVILIAN	82-3/91	I/O		56110-S9411	MLS	O/I		56210-S9001	
						O/O	M63178		
	92-99	I/O		56110-44T00	PSS	O/I		56210-41T25 56210-S9401 56210-S9501	
	92-99	I/O		56110-34T00	AIR	O/I		56210-34T00	
W40 CIVILIAN (NZ)		I/O	M63448	56110-WK100					
DA67 (NZ)						O/I		56210-90009	AIR
E210		I/O	M85316 M89426	56110-90167		O/O	M85308 M89422	56210-Z6003	AIR

MOUNTING DIAGRAMS

O/O	Top Eye (with sleeve) / Bottom Eye (with sleeve)	I/I	Top Pin/Stud / Bottom Pin/Stud	O/O	Top Eye / Bottom Eye
O/O	Top Eye (with sleeve) / Bottom Eye	I/O	Top Pin/Stud / Bottom Eye	O/I	Top Eye / Bottom Pin/Stud
O/I	Top Eye (with sleeve) / Bottom Pin/Stud	I/O	Top Pin/Stud / Bottom Eye (with sleeve)	O/O	Top Eye / Bottom Eye (with sleeve)

1. Please see the Cross Reference section of this catalog for a complete list of OE references.
2. Part number marked in **Bold Italic** represent the Premium, adjustable, heavy duty gas shock absorbers.



		FRONT				REAR			
		Mount	MERITOR	OE	REMARKS	Mount	MERITOR	OE	REMARKS

OPTAREZ NZ

MR15 (NZ)	97	I/I	2555						
-----------	----	-----	------	--	--	--	--	--	--

RENAULT

PR100	97-			0023512099				0023512161	
PR100.3 (Route Bus)	97-							0023512161	AIR
PR180 (Articulated Centre Axle)						I/O	4392	5000788364	

SCANIA

F94 (NZ)	2005-	I/O	P319M4		MLS					
K 82		I/O	2558	307111	SS	I/I	4249	419131		
		I/I	40106	410554 429161 429163-9 470264	AIR			403245	468198 470268	tag axle
				I/O	2558			307111 415844	SS	
K 92		I/I	40106	410554 429163-9 470264	AIR	I/I	4249	424307 415849-9		
								468198 470268	tag axle	
K 93 CRB		I/I	40106	470264 485131		I/I	4249	470268		
K 94EB (4x2)	99	I/I	40106	488824 1523289		I/I	40106	1481359		
K 94IB (4x2) (School Bus & Coach Chassis)	99-	I/O	4308	1480214 1480215 1523283 483550						
K 94UB (4x2) (6x4)	99-	I/I	40106	1462240 1488337 1920824		I/I	2555	1478317		
K 112		I/O	2558	307111 415844	SS	I/I	4249	419131		
		I/I	40106	410554 415848 429161 429163 470264 475910 485131	inc. high body AIR			429162 470268	inc. tag axle	
K 113 CRB, K 113 T, K 113 TRB		I/I	40106	410554 429161 470264 475910 485131	AIR	I/I	4249	415849 468189 468198 470267 470268		
									I/O	4028

SYMBOLS

AIR	Air Suspension	TAP	Tapered Leaf Suspension	SS	Spring Suspension	TBS	Torsion Bar Suspension
PSS	Parabolic Spring Suspension	AEON	AEON Spring	TLS	Trapezium Leaf Suspension		
MLS	Multi Leaf Suspension	RBS	Rubber Block Suspension	IFS	Independant Front Suspension		

1. Please see the Cross Reference section of this catalog for a complete list of OE references.

2. Part number marked in **Bold Italic** represent the Premium, adjustable, heavy duty gas shock absorbers.



www.meritorpartsonline.com

		FRONT				REAR			
		Mount	MERITOR	OE	REMARKS	Mount	MERITOR	OE	REMARKS

SCANIA

K 124 IB (6x2) (3 Axle Coach)	99-	I/O	4308	1427406 1480213 1480214 1480215 483550 1523283 1523287 1523288		I/I	40106	470268 483553	inc. tag axle
K 124 EB (6x2) (3 Axle Coach)	99-					I/I	40106	470268 483551 483553	inc. tag axle
K 124 IB (8x2)	99-	I/O	4308	1427406 1480213 1480214 1480215 483550 1523283 1523287 1523288		I/I	40106	470268 483551 483553	
								483552 488274 489513	tag axle
L 94IB		I/O	4308	1480214 1480215 483550 1523283					
L 94UB (4x2) (6x2) (Low Floor City Bus)	98-	I/O	4308	1480214		I/I	2555	1478317	
							40106	483551	inc. tag axle
L 113 CLD, 113 CRB, L 113 CRL		I/I	40106	410554 429161 470264		I/I	4249	468189 470267 470268	
				475915 489167			I/O	4028	468194
N 112		I/I	40106	410554 429161 470264 1677860		I/I	4249	429162	inc. tag axle
N 113		I/I	40106	410554 429161 470264		I/I	4249	415849 468189 470267 470268	
				475915 489167			I/O	4028	468194

SEDDON NZ



Pennine (4 & 6 Cyl)	75	I/I	4428						
			M85310 M89423						

Note: Check front shock lengths for correct application

MOUNTING DIAGRAMS

O/O	Top Eye (with sleeve) / Bottom Eye (with sleeve)	I/I	Top Pin/Stud / Bottom Pin/Stud	O/O	Top Eye / Bottom Eye
O/O	Top Eye (with sleeve) / Bottom Eye	I/O	Top Pin/Stud / Bottom Eye	O/I	Top Eye / Bottom Pin/Stud
O/I	Top Eye (with sleeve) / Bottom Pin/Stud	I/O	Top Pin/Stud / Bottom Eye (with sleeve)	O/O	Top Eye / Bottom Eye (with sleeve)

1. Please see the Cross Reference section of this catalog for a complete list of OE references.
2. Part number marked in **Bold Italic** represent the Premium, adjustable, heavy duty gas shock absorbers.

		FRONT				REAR			
		Mount	MERITOR	OE	REMARKS	Mount	MERITOR	OE	REMARKS

SETRA

Front & Drive Axle	86	I/I	45078	8.231.220.000		I/I	2555	8.231.187.000	inc. tag axle
--------------------	----	-----	-------	---------------	--	-----	------	---------------	---------------

SPARTAN

SBRE 230	99-	O/O		90-1943SP4	Reyco AIR				
Z2-560 (NZ)	99-	O/O				O/O	M85005 M89430		Reyco AIR
						O/O	M83128		tag axle

TOYOTA

Coaster

BB10, BB11	-4/82	O/O	M63178	48511-39235		O/O	M63173	48531-39115	
BB20, BB21R		I/O		48511-36110 48511-39345		O/O	M63178	48531-36110 48531-39525	
BB26 (NZ)	93-	I/O		48511-36240		O/O	M63178	48531-36100	
BB40R	7/93-	I/O		48511-36240		O/O	M85012 M89413	48531-36160 48531-80154	
BU19	-7/77	O/O	M63299	48511-39075 48511-39076		O/O	M63173	48531-39115	
HB30, HZB30R	5/82	I/O		48511-36110 48511-36240 48511-39345		O/O	M63178	48531-39495	
HDB20 (NZ), HDB31 (NZ)	92-	I/O		48511-36110 48511-36240		O/O			
HB31, HB32	82-93	I/O		48511-36110 48511-36240		O/O	M63178	48531-36140 48531-80579	16mm mounts 19mm mounts
HDB50 (NZ), HDB51 (NZ)	93-	I/O		48511-36110 48511-36240		O/O	M85012 M89413		
HZB41						O/O	M85012 M89413		
HZ50R, HZB50R	7/83-	I/O		48511-36110 48511-36240		O/O	M85012 M89413	48531-36160 48531-80154	
JU18	67-1/72	O/O	M63299	48511-39075		O/O	M63178	48531-69015	
RB11, RB12, RB13	8/77	O/O	M63178	48511-39235		O/O	M63173	48531-39115	
RB20, RB21R	5/82	I/O		48511-36110 48511-36240 48511-39345		O/O	M63178	48531-39525	
RU18	67-1/72	O/O	M63299	48511-39075		O/O	M63178	48531-69015	
RU19	2/72	O/O	M63299	48511-39075 48511-39076		O/O	M63173	48531-39115	
RU23, RU30		I/O		48511-36110 48511-36240 48511-39345		O/O	M63178	48531-39505 48531-39515 48531-39525	

SYMBOLS

AIR	Air Suspension	TAP	Tapered Leaf Suspension	SS	Spring Suspension	TBS	Torsion Bar Suspension
PSS	Parabolic Spring Suspension	AEON	AEON Spring	TLS	Trapezium Leaf Suspension		
MLS	Multi Leaf Suspension	RBS	Rubber Block Suspension	IFS	Independant Front Suspension		

1. Please see the Cross Reference section of this catalog for a complete list of OE references.

2. Part number marked in **Bold Italic** represent the Premium, adjustable, heavy duty gas shock absorbers.



www.meritorpartsonline.com

		FRONT				REAR			
		Mount	MERITOR	OE	REMARKS	Mount	MERITOR	OE	REMARKS

UD / NISSAN

CB20		I/O	76103			I/O			
E210 (NZ)						O/O	M85308 M89422	56210-Z6003	
FRS Truck Chassis		I/O	M63320			O/O	M85308 M89422		
JM210 (NZ)		I/O	M85311	56110-90172	SS	I/I	4428		AIR
JP211 (NZ)	95-	O/O	M85304	56110-Z6012	PSS				
JP521		I/O	M63322						
RB30, RB31	5/78	I/O	M85311	56110-90Z01 56110-90201		I/O	M85311	56210-90003	
RB80GR	89	I/O	M85316 M89426	56110-90167		I/I		56210-90064	AIR
RM80, RM80G, RM81, RM81E		I/O	M63322	56110-Z5003 56110-Z5004		I/I	M83318	56110-Z5002	
RM81G (NZ)		I/O	76043	56110-90064	AIR	I/I	2508		
RM210 (NZ)	91	I/O	76043		AIR	I/I			
RT81		O/O		56110-90062					
U32L (NZ)		I/O	76103		MLS				
U33L (NZ)						O/O	M85305 M89425		
UA50L (NZ)		O/O	M85308 M89422		AIR				
UA440 (NZ)						O/O	M85305 M89425	56210-90019	
UA460 (NZ)	95	I/I	76041	56110-Z6070					

VOLVO

B6, B6BLE		O/O		3039243	AIR	O/O	M85007 M89412	3039244	AIR
B6F						O/I	7051	6856631	
B6FA		I/I	2555	6874412		O/I	7051	6873143	
		O/O	M83101	6779275					
B6M		O/O	M83101	6779275	SS	O/I	7051	6873143-2	SS
B7L, B7LA	99-	I/I	M85310 M89423	3112260		I/I	76041	3112261 9522179	inc. B7LA centre Axle
B7R (4x2)	97-					O/I	7051	6873143	
B10B	97-	O/O	2774	3037213 3073213P01	IFS (AIR)	O/O	40275	3036162	AIR
B10BLE	98-	O/O	40122	9516389	Chassis ~ 2696	O/O	40275	3036162	AIR
		I/I	M85310 M89423	3112260	Chassis 2697 ~				
B10L		I/I	M85310 M89423	3112260	AIR	I/I	76041	3112261	AIR
								9522179	Articulated

MOUNTING DIAGRAMS

O/O	Top Eye (with sleeve) / Bottom Eye (with sleeve)	I/I	Top Pin/Stud / Bottom Pin/Stud	O/O	Top Eye / Bottom Eye
O/O	Top Eye (with sleeve) / Bottom Eye	I/O	Top Pin/Stud / Bottom Eye	O/I	Top Eye / Bottom Pin/Stud
O/I	Top Eye (with sleeve) / Bottom Pin/Stud	I/O	Top Pin/Stud / Bottom Eye (with sleeve)	O/O	Top Eye / Bottom Eye (with sleeve)

1. Please see the Cross Reference section of this catalog for a complete list of OE references.
2. Part number marked in **Bold Italic** represent the Premium, adjustable, heavy duty gas shock absorbers.



		FRONT				REAR			
		Mount	MERITOR	OE	REMARKS	Mount	MERITOR	OE	REMARKS

VOLVO

B10M MK1		O/O	40274	1134748 1136643	Chassis ~ 11500	O/O	40275	1134749		
				1190777 3030066 8365828	Steering Damper	O/O	40275	1134749	tag axle	
						O/O	40274	1134748	Steered tag axle	
B10M MK2		O/O	40274	1134748	Chassis 11500 ~ 20000	O/O	40275	1134749		
				1190777 3030066 8365828	Steering Damper	O/O	40275	1134749	tag axle	
						O/O	40274	1134748	Steered tag axle	
B10M MK3		O/O	2753	3031623	Chassis 20001 ~ 45000	O/O	40275	3031624	tag axle	
			2774	3027113						
				1190777 3030066 8365828	Steering Damper		2753	3031623	Steered tag axle	
B10M MK4		O/O	2774	3027113	Chassis 45001 ~	I/O				
				1190777 3030066 8365828	Steering Damper	O/O	40275	3031624		
						O/O	40275	3031624	tag axle	
B12		O/O	2774	3027113 3037213	AIR	O/O	40275	3031624 3031626 3036162		
B12B (3 Axle Coach Chassis), B12B-LE (Ultra low Floor)	02-	I/I	76041	70313745	IFS					
B58		O/O	2557	365376	MLS	O/O	4199	365377		
							O/O	M85031		(NZ) tag axle
				1130538-0	AIR	O/O	4199	1130539-8		
B59		I/I	2555	366426	AIR	I/I	4344	366427		

ZONDA NZ

8.5MTR	2007-	O/O	M85005 M89430		AIR	O/O	M85054 M89438		
--------	-------	-----	-------------------------	--	------------	-----	-------------------------	--	--

MOUNTING DIAGRAMS

O/O	Top Eye (with sleeve) / Bottom Eye (with sleeve)	I/I	Top Pin/Stud / Bottom Pin/Stud	O/O	Top Eye / Bottom Eye
O/O	Top Eye (with sleeve) / Bottom Eye	I/O	Top Pin/Stud / Bottom Eye	O/I	Top Eye / Bottom Pin/Stud
O/I	Top Eye (with sleeve) / Bottom Pin/Stud	I/O	Top Pin/Stud / Bottom Eye (with sleeve)	O/O	Top Eye / Bottom Eye (with sleeve)

1. Please see the Cross Reference section of this catalog for a complete list of OE references.
2. Part number marked in **Bold Italic** represent the Premium, adjustable, heavy duty gas shock absorbers.



REAR SUSPENSION

AIRGLIDE	1
AIRLINER	1
HENDRICKSON AIR SUSPENSION	1-2
KENWORTH TORSION BAR SUSPENSION	3
MACK	3
NEWAY DRIVE SUSPENSION	3-4



REAR

Mount	MERITOR	OE	REMARKS
-------	---------	----	---------

AIRGLIDE

100 (with shocks mounted inside chassis rail)

Airglide 100		I/I	M85310 M89423	K374-7	8 bags (Inboard Shock mounts)
--------------	--	-----	-------------------------	--------	----------------------------------

200 / 400 / 600 (with shocks mounted outside chassis rail)

Airglide 200, 400 , 600		I/I	M85900	665903	9" ride height
		O/I		K374-43	
		I/I	M85902	665906	10.5" ride height
		I/I	M85902	K374-38	
		O/I		K374-44	

AIRLINER

23K, 40K, 46K		O/O	M85724 M89443	16-15817-000	
Tufftrac 40K, 46K		O/O	M85956	16-15770-000	

HENDRICKSON AIR SUSPENSION

AR2

AR2		O/O	M83122 M89406	47902-3	drive suspension
-----	--	-----	-------------------------	---------	------------------

HA

HA400 (Mack only)		O/O	M83123 M89405	47902-9	
HA400, HA460, HA600		O/O	M83122 M89406	47902-3	

HAS

HAS200		O/O	M85013	47902-24	
			M83144	60670-007L	
HAS200L		O/O	M83123 M89405	47902-9	
HAS190, HAS200, HAS210, HAS230, HAS231		O/O	M85013	47902-15	
			M83121	58715-1	
			M83144	60670-007	
			M83209 M89414	60675-003	
HAS381		O/O	M85013	60670-005L	

MOUNTING DIAGRAMS

O/O	Top Eye (with sleeve) / Bottom Eye (with sleeve)	I/I	Top Pin/Stud / Bottom Pin/Stud	O/O	Top Eye / Bottom Eye
O/O	Top Eye (with sleeve) / Bottom Eye	I/O	Top Pin/Stud / Bottom Eye	O/I	Top Eye / Bottom Pin/Stud
O/I	Top Eye (with sleeve) / Bottom Pin/Stud	I/O	Top Pin/Stud / Bottom Eye (with sleeve)	O/O	Top Eye / Bottom Eye (with sleeve)

1. Please see the Cross Reference section of this catalog for a complete list of OE references.
2. Part number marked in **Bold Italic** represent the Premium, adjustable, heavy duty gas shock absorbers.





REAR

Mount	MERITOR	OE	REMARKS
-------	---------	----	---------

HENDRICKSON AIR SUSPENSION

HAS

HAS400, HAS402, HAS460, HAS461	O/O	M85013	47902-24	
		M83121	58715-1	
		M83144	60670-007	
		M83209 M89414	60675-002	
HAS690	O/O	M85013	60670-005	
HAS691	O/O	M83209 M89414	60675-002	

HN

HN402	O/I	M83112	57241-3	RBS
HN402, HN462 (Europe)	O/O	M83207 M89407	5010130641	RBS
	O/I	M83112	57241-003	RBS
HN460 (AUST)	O/O	M83207 M89407	47902-11	RBS
HN460 (NZ)	O/O	M83207 M89407	47902-11	RBS (UK Model)
		M85010		RBS (USA Model)

PAX (Primax)

PAX230	O/O	M85072	60657-003	(single axle) 8.5", 10" ride height
		M85967	60665-011	12.5", 14.375", 15.5" ride height
PAX460	O/O	M85072	60657-003	(dual axle) 8.5", 10" ride height
		M85967	60665-011	12.5", 14.375", 15.5" ride height
PAX690	O/O	M85072	60657-003	(tri axle) 8.5", 10" ride height
		M85967	60665-011	12.5", 14.375", 15.5" ride height

WD

WD460	O/O	M85030 M89440	47902-023	
		M85909	S-20886	
WD2 460	O/O	M85909	S-20886	

SYMBOLS

AIR	Air Suspension	TAP	Tapered Leaf Suspension	SS	Spring Suspension	TBS	Torsion Bar Suspension
PSS	Parabolic Spring Suspension	AEON	AEON Spring	TLS	Trapezium Leaf Suspension		
MLS	Multi Leaf Suspension	RBS	Rubber Block Suspension	IFS	Independant Front Suspension		

1. Please see the Cross Reference section of this catalog for a complete list of OE references.

2. Part number marked in **Bold Italic** represent the Premium, adjustable, heavy duty gas shock absorbers.



www.meritorpartsonline.com



REAR

Mount	MERITOR	OE	REMARKS
-------	---------	----	---------

KENWORTH TORSION BAR SUSPENSION

O/O	M85305 M89425	K374-4	
-----	-------------------------	--------	--

MACK

MAXLITE 40	O/O	M85013	60670-5	AIR
MACK AL231	O/O	M83123	47902-9	AIR
MACK AL460	O/O	M85013	60670-5	AIR
		M83147	60670-6	
MACK AP460	O/O	M85072	60657-3	AIR

NEWAY DRIVE SUSPENSION

AD-123 / AD-126 / AD-130

O/O	M85030 M89440	3501001	10" ride height
		90045504	

ARD

O/O	M85013	14QK29408M	
-----	--------	------------	--

ARD-244

O/O	M85013	90044025	
-----	--------	----------	--

ARDST-244

O/O	M85013	90044025	slimline body
O/O	M83209 M89414	90044968	large body

NEWAY DRIVE SUSPENSION

ARDST MK1

O/O	M85013	14QK29408M	
-----	--------	------------	--

ARDST MK2

O/O	M83209 M89414	14QK29401M	
-----	-------------------------	------------	--

AD-246

	O/O	M85906	14QK414M	8.5" ride height	
	O/O	M85906	90045099	8.75" ride height	
	~ 2000	O/O	M83144 M85909	90045132	10" ride height single stud
	2000 ~	O/O	M85030 M89440	3501001 90045504	10" ride height double stud
Dana DR.462P, DR463HD	O/O	M85030 M89440	14QK39406M	10" ride height	
Mack NAS.36C, NAS.462C	O/O	M85909	14QK414M2	10" ride height	

MOUNTING DIAGRAMS

O/O	Top Eye (with sleeve) / Bottom Eye (with sleeve)	I/I	Top Pin/Stud / Bottom Pin/Stud	O/O	Top Eye / Bottom Eye
O/O	Top Eye (with sleeve) / Bottom Eye	I/O	Top Pin/Stud / Bottom Eye	O/I	Top Eye / Bottom Pin/Stud
O/I	Top Eye (with sleeve) / Bottom Pin/Stud	I/O	Top Pin/Stud / Bottom Eye (with sleeve)	O/O	Top Eye / Bottom Eye (with sleeve)

1. Please see the Cross Reference section of this catalog for a complete list of OE references.
2. Part number marked in **Bold Italic** represent the Premium, adjustable, heavy duty gas shock absorbers.





REAR

Mount	MERITOR	OE	REMARKS
-------	---------	----	---------

NEWAY DRIVE SUSPENSION

AD-246

Meritor RT40-145GP, RT46-160GP		○/○	M85909	14QK29406M	10" ride height
Meritor RT-160GP		○/○	M85030 M89440	14QK39406M	10" ride height
SISU		○/○	M85072	14QK429M2	10" ride height
Dana DR.462P, DR.463P		○/○		14QK39407M	11" ride height
Dana DS.521P		○/○	M85909	14QK29406M	11" ride height
Mack NAS.462, Meritor RT46-1260GP, RT50-160GP		○/○	M85308	14QK39405M 14QK39407M	11" ride height
	2000 ~	○/○	M85030 M89440	3501001 90045504	11" ride height single stud
Mack NAS.462C		○/○		14QK29405M 14QK39404M	12" ride height

AD252

		○/○		14QK39401M 14QK39403M	
	2001-	○/○	M85030 M89440	3501001	8.75", 10" ride height
Dana DS.521P, Mack NAS.462C, Meritor RT52-185G, R.V.I SA52/1845B		○/○		14QK39403M	11" ride height

AD-260

		○/○	M85030 M89440	3501001	10" ride height
--	--	-----	-------------------------	---------	-----------------

AD-369

		○/○	M85030 M89440	3501001 90045504	10" ride height
Mack NAS.692C		○/○		14QK29405M 14QK39404M	12" ride height

AD-378

		○/○	M85030 M89440	3501001	10" ride height
Mack NAS.692C, Meritor RZ78-388G, R.V.I EA78/1845B		○/○		14QK39403M	11" ride height

AD-390

		○/○	M85030 M89440	3501001	8.75", 10" ride height
--	--	-----	-------------------------	---------	---------------------------

MOUNTING DIAGRAMS

○/○	Top Eye (with sleeve) / Bottom Eye (with sleeve)	I/I	Top Pin/Stud / Bottom Pin/Stud	○/○	Top Eye / Bottom Eye
○/○	Top Eye (with sleeve) / Bottom Eye	I/O	Top Pin/Stud / Bottom Eye	○/I	Top Eye / Bottom Pin/Stud
○/I	Top Eye (with sleeve) / Bottom Pin/Stud	I/O	Top Pin/Stud / Bottom Eye (with sleeve)	○/○	Top Eye / Bottom Eye (with sleeve)

1. Please see the Cross Reference section of this catalog for a complete list of OE references.
2. Part number marked in **Bold Italic** represent the Premium, adjustable, heavy duty gas shock absorbers.



TECHNICAL SPECS

SHOCK ABSORBER DIMENSIONS 1-4
SHOCK ABSORBER DIAGRAMS 5

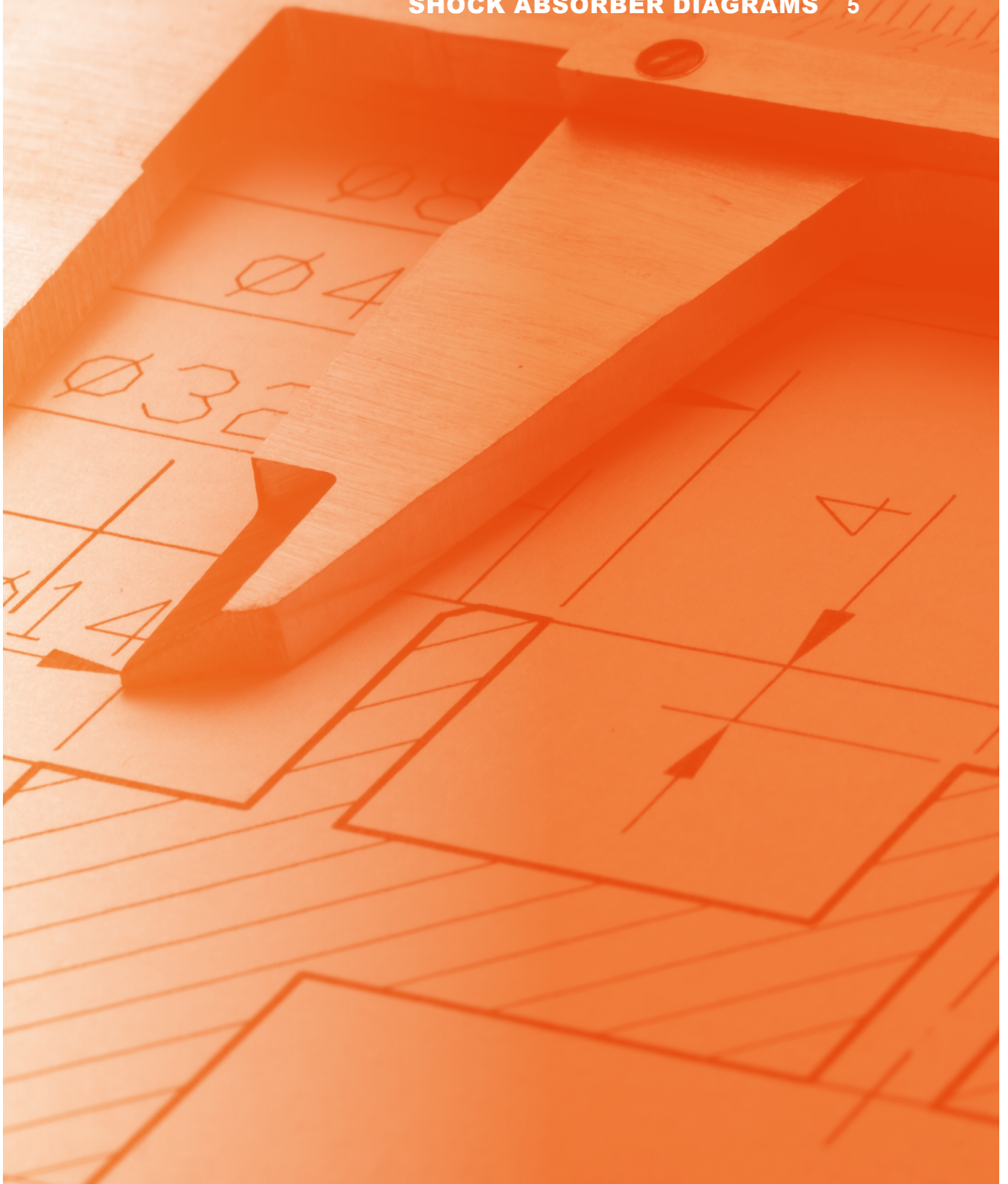

Part Number	Description	Bore (mm)	Ext Length (mm)	Coil Length (mm)	Stroke (mm)	Dust Shield dia. (mm)	Body dia. (mm)
M646155	Stabilizer	30.00	569.70	355.40	214.30	86.50	50.80
M83001	Cab Damper	35.00	BC 264.80	BC 212.90	51.90	60.50	50.80
M83008	Cab Damper	35.00	331.60	261.40	70.20	60.50	50.80
M83009	Cab Damper	35.00	BC 264.80	BC 212.90	51.90	60.50	50.80
M83021	Cab Damper	35.00	234.80	186.80	48.00	60.50	50.80
M83025	Cab Damper	35.00	BC 199.10	165.00	34.10	60.50	50.80
M83028	Cab Damper	35.00	BC 248.40	192.90	55.80	60.50	50.80
M83029	Cab Damper	35.00	262.80	201.10	61.70	60.50	50.80
M83038	Cab Damper	35.00	BC 264.80	BC 212.90	51.90	60.50	50.80
M83111	Standard	35.00	663.70	403.00	260.70	60.50	50.80
M83112	Standard	35.00	547.00	340.20	206.80	60.50	50.80
M83121	Standard	35.00	768.30	464.80	303.50	60.50	50.80
M83122	Standard	35.00	641.40	399.80	241.60	60.50	50.80
M83123	Standard	35.00	676.50	415.80	260.70	60.50	50.80
M83124	Standard	35.00	549.90	348.70	201.20	60.50	50.80
M83125	Standard	35.00	714.20	434.50	279.70	60.50	50.80
M83127	Standard	35.00	511.10	333.00	178.10	60.50	50.80
M83128	Standard	35.00	428.60	291.90	136.70	60.50	50.80
M83136	Standard	35.00	742.10	424.30	317.80	60.50	50.80
M83147	Standard	35.00	724.60	440.90	283.70	60.50	50.80
M83203	Standard	35.00	434.30	288.00	146.30	60.50	50.80
M83207	Standard	35.00	549.80	345.30	204.50	60.50	50.80
M83209	Standard	35.00	752.90	446.80	306.10	60.50	50.80
M83215	Standard	35.00	672.70	413.20	259.50	60.50	50.80
M83456	Standard	30.00	610.10	362.60	247.50	50.80	41.00
M85000	Standard	41.00	437.40	291.10	146.30	63.50	55.50
M85001	Standard	41.00	667.40	415.20	252.20	63.50	55.50
M85003	Standard	41.00	644.60	395.60	249.00	63.50	55.50
M85005	Standard	41.00	628.70	386.70	242.00	63.50	55.50
M85006	Standard	41.00	723.90	434.10	289.80	63.50	55.50
M85007	Standard	41.00	614.60	378.80	226.80	63.50	55.60
M85012	Standard	41.00	533.60	336.00	197.60	63.50	55.50
M85013	Standard	41.00	756.90	450.80	306.10	63.50	55.50
M85014	Standard	41.00	552.20	348.20	204.00	63.50	55.50
M85029	Standard	41.00	520.70	332.50	188.20	63.50	55.50
M85030	Standard	41.00	609.60	376.90	232.70	63.50	55.50
M85033	Standard	41.00	691.40	440.90	250.50	63.50	55.50
M85036	Standard	41.00	670.30	413.50	256.80	63.50	55.50
M85043	Standard	41.00	701.40	427.00	274.40	63.50	55.50
M85045	Standard	41.00	368.80	256.50	112.30	63.50	55.50
M85046	Standard	41.00	698.90	421.80	277.10	63.50	55.50
M85047	Standard	41.00	642.60	393.60	249.00	63.50	55.50
M85052	Standard	41.00	336.60	240.50	96.10	63.50	55.50
M85053	Standard	41.00	626.20	393.00	233.20	63.50	55.50
M85062	Standard	41.00	502.00	320.20	181.80	63.50	55.50

Bore (inch)	Ext Length (inch)	Coll Length (inch)	Stroke (inch)	Dust Shield dia. (inch)	Body dia. (inch)	Part Number
1.18	22.43	13.99	8.44	3.41	2.00	M646155
1.38	BC 10.43	BC 8.38	2.04	2.38	2.00	M83001
1.38	13.06	10.29	2.38	2.38	2.00	M83008
1.38	BC 10.43	BC 8.38	2.04	2.38	2.00	M83009
1.38	9.24	7.35	2.50	2.38	2.00	M83021
1.38	BC 7.84	6.50	1.34	2.38	2.00	M83025
1.38	9.78	2.20	2.38	2.38	2.00	M83028
1.38	10.35	7.92	2.43	2.38	2.00	M83029
1.38	BC 10.43	BC 8.38	2.04	2.38	2.00	M83038
1.38	26.13	15.87	10.26	2.38	2.00	M83111
1.38	21.54	13.39	8.14	2.38	2.00	M83112
1.38	30.25	18.30	11.95	2.38	2.00	M83121
1.38	25.25	15.74	9.51	2.38	2.00	M83122
1.38	26.63	16.37	10.26	2.38	2.00	M83123
1.38	21.65	13.73	7.92	2.38	2.00	M83124
1.38	28.12	17.11	11.01	2.38	2.00	M83125
1.38	20.12	13.11	7.01	2.38	2.00	M83127
1.38	16.87	11.49	5.38	2.38	2.00	M83128
1.38	29.22	16.70	12.51	2.38	2.00	M83136
1.38	28.53	17.36	11.17	2.38	2.00	M83147
1.38	17.10	11.34	5.76	2.38	2.00	M83203
1.38	21.65	13.59	8.05	2.38	2.00	M83207
1.38	29.64	17.59	12.05	2.38	2.00	M83209
1.38	26.48	16.27	10.22	2.38	2.00	M83215
1.18	24.02	14.28	9.74	2.00	1.63	M83456
1.63	17.22	11.46	5.76	2.50	2.19	M85000
1.63	26.28	16.35	9.93	2.50	2.19	M85001
1.63	25.38	15.57	9.80	2.50	2.19	M85003
1.63	24.75	15.22	9.53	2.50	2.19	M85005
1.63	28.50	17.09	11.41	2.50	2.19	M85006
1.63	24.20	14.91	8.93	2.50	2.19	M85007
1.63	21.01	13.23	7.78	2.50	2.19	M85012
1.63	29.80	17.75	12.05	2.50	2.19	M85013
1.63	21.74	13.71	8.03	2.50	2.19	M85014
1.63	20.50	13.09	7.41	2.50	2.19	M85029
1.63	24.00	14.84	9.16	2.50	2.19	M85030
1.63	27.22	17.36	9.86	2.50	2.19	M85033
1.63	26.39	16.28	10.11	2.50	2.19	M85036
1.63	27.61	16.81	10.80	2.50	2.19	M85043
1.63	14.52	10.10	4.42	2.50	2.19	M85045
1.63	27.52	16.61	10.91	2.50	2.19	M85046
1.63	25.30	15.50	9.80	2.50	2.19	M85047
1.63	13.25	9.47	3.78	2.50	2.19	M85052
1.63	24.65	15.47	9.18	2.50	2.19	M85053
1.63	19.76	12.61	7.16	2.50	2.19	M85062



Part Number	Description	Bore (mm)	Ext Length (mm)	Coll Length (mm)	Stroke (mm)	Dust Shield dia. (mm)	Body dia. (mm)
M85064	Standard	41.00	402.70	273.70	129.00	63.50	55.50
M85067	Standard	41.00	774.70	459.70	315.00	63.50	55.50
M85072	Standard	41.00	613.90	376.10	237.80	63.50	55.50
M85300	Standard	41.00	457.40	310.00	147.40	82.50	69.90
M85301	Standard	41.00	810.80	483.50	327.30	82.50	69.90
M85303	Standard	41.00	628.40	392.80	235.60	82.50	69.90
M85305	Standard	41.00	692.20	424.80	267.40	82.50	69.90
M85310	Standard	41.00	473.70	297.70	176.00	82.50	69.90
M85311	Standard	41.00	608.70	375.50	233.20	82.50	69.90
M85316	Standard	41.00	523.40	326.40	197.00	82.50	69.90
M85319	Standard	41.00	563.80	353.00	210.80	82.50	69.90
M85320	Standard	41.00	663.90	414.90	249.00	82.50	69.90
M85323	Standard	41.00	440.80	293.50	147.30	82.50	69.90
M85724	Standard	41.00	578.70	367.80	210.90	82.50	69.90
M85727	Standard	41.00	759.20	440.40	318.80	82.50	69.90
M85738	Standard	41.00	443.60	296.50	147.10	82.50	69.90
M85900	Standard	41.00	438.60	282.90	155.70	69.90	60.50
M85901	Standard	41.00	737.90	447.60	290.30	69.90	60.50
M85902	Standard	41.00	482.80	305.00	177.80	69.90	60.50
M85909	Standard	41.00	615.20	383.20	232.00	69.90	60.50
M85918	Standard	41.00	583.40	369.30	214.10	69.90	60.50
M85919	Standard	41.00	571.10	361.60	209.50	69.90	60.50
M85923	Standard	41.00	570.70	367.50	203.20	69.90	60.50
M85924	Standard	41.00	518.60	329.30	189.30	69.90	60.50
M85931	Standard	41.00	570.70	367.50	203.20	69.90	60.50
M85938	Standard	41.00	407.80	273.80	137.00	69.90	60.50
M89408	Premium Adjustable	41.00	499.70	324.90	174.80	69.90	60.50
M89410	Premium Adjustable	41.00	668.30	416.60	251.70	69.90	60.50
M89411	Premium Adjustable	41.00	642.30	397.30	245.00	69.90	60.50
M89413	Premium Adjustable	41.00	531.20	340.70	190.50	69.90	60.50
M89414	Premium Adjustable	41.00	752.30	458.20	294.10	69.90	60.50
M89423	Premium Adjustable	41.00	473.40	306.30	167.10	69.90	60.50
M89424	Premium Adjustable	41.00	601.60	380.60	221.00	69.90	60.50
M89427	Premium Adjustable	41.00	690.90	444.50	246.40	69.90	60.50
M89429	Premium Adjustable	41.00	665.00	417.40	247.60	69.90	60.50
M89430	Premium Adjustable	41.00	20.30	387.40	232.90	69.90	60.50
M89436	Premium Adjustable	41.00	437.60	302.20	135.40	69.90	60.50
M89443	Premium Adjustable	41.00	563.10	363.50	199.60	69.90	60.50
M89448	Premium Adjustable	41.00	625.30	394.60	230.70	69.90	60.50
M89449	Premium Adjustable	41.00	586.20	373.40	212.80	69.90	60.50
M89450	Premium Adjustable	41.00	629.30	390.80	238.50	69.90	60.50
M89451	Premium Adjustable	41.00	771.10	467.50	303.60	69.90	60.50

Bore (inch)	Ext Length (inch)	Coll Length (inch)	Stroke (inch)	Dust Shield dia. (inch)	Body dia. (inch)	Part Number
1.63	15.85	10.78	5.08	2.50	2.19	M85064
1.63	30.50	18.10	12.40	2.50	2.19	M85067
1.63	24.17	14.81	9.36	2.50	2.19	M85072
1.63	18.01	12.20	5.80	3.25	2.75	M85300
1.63	31.92	19.04	12.89	3.25	2.75	M85301
1.63	24.74	15.46	9.28	3.25	2.75	M85303
1.63	27.25	16.72	10.53	3.25	2.75	M85305
1.63	18.65	11.72	6.93	3.25	2.75	M85310
1.63	23.96	14.78	9.18	3.25	2.75	M85311
1.63	20.61	12.85	7.76	3.25	2.75	M85316
1.63	22.20	13.90	8.30	3.25	2.75	M85319
1.63	26.14	16.33	9.80	3.25	2.75	M85320
1.63	17.35	11.56	5.80	3.25	2.75	M85323
1.63	22.78	14.48	8.30	3.25	2.75	M85724
1.63	29.89	17.34	12.55	3.25	2.75	M85727
1.63	17.46	11.67	5.79	3.25	2.75	M85738
1.63	17.27	11.14	6.13	2.75	2.38	M85900
1.63	29.05	17.62	11.43	2.75	2.38	M85901
1.63	19.01	12.01	7.00	2.75	2.38	M85902
1.63	24.22	15.09	9.13	2.75	2.38	M85909
1.63	22.97	14.54	8.43	2.75	2.38	M85918
1.63	22.48	14.24	8.25	2.75	2.38	M85919
1.63	22.47	14.47	8.00	2.75	2.38	M85923
1.63	20.42	12.96	7.45	2.75	2.38	M85924
1.63	22.47	14.47	8.00	2.75	2.38	M85931
1.63	16.06	10.78	5.39	2.75	2.38	M85938
1.63	19.67	12.79	6.88	2.75	2.38	M89408
1.63	26.31	16.40	9.91	2.75	2.38	M89410
1.63	25.29	15.64	9.65	2.75	2.38	M89411
1.63	20.91	13.41	7.50	2.75	2.38	M89413
1.63	29.62	18.04	11.58	2.75	2.38	M89414
1.63	18.64	12.06	6.58	2.75	2.38	M89423
1.63	23.69	14.98	8.70	2.75	2.38	M89424
1.63	27.20	17.50	9.70	2.75	2.38	M89427
1.63	26.18	16.43	9.75	2.75	2.38	M89429
1.63	24.42	15.25	9.17	2.75	2.38	M89430
1.63	17.23	11.90	5.33	2.75	2.38	M89436
1.63	22.17	14.31	7.86	2.75	2.38	M89443
1.63	24.62	15.54	9.08	2.75	2.38	M89448
1.63	23.08	14.70	8.38	2.75	2.38	M89449
1.63	24.78	15.39	9.39	2.75	2.38	M89450
1.63	30.36	18.41	11.95	2.75	2.38	M89451

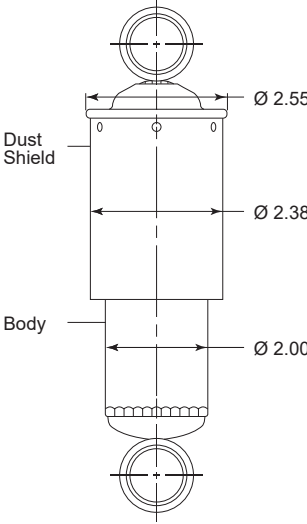
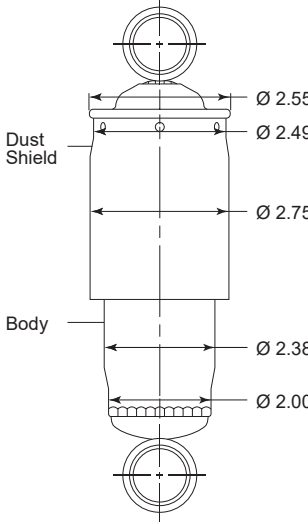
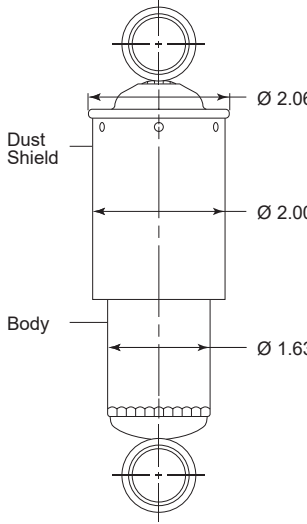
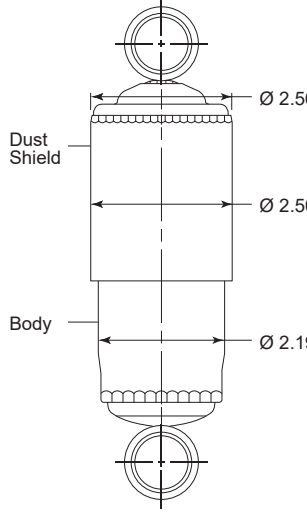
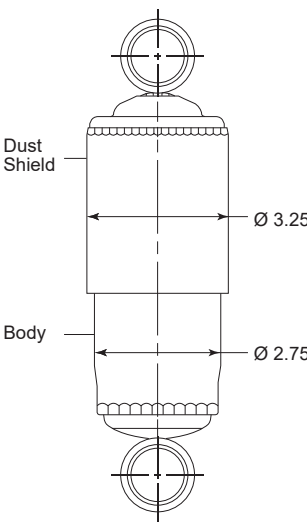
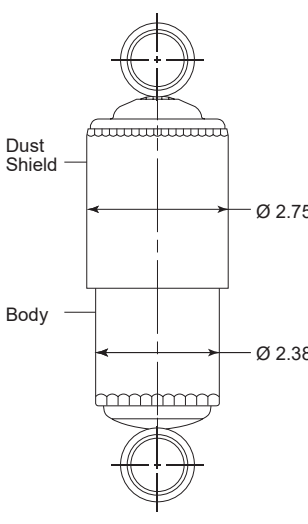
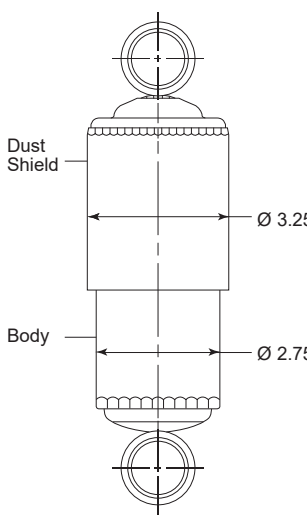
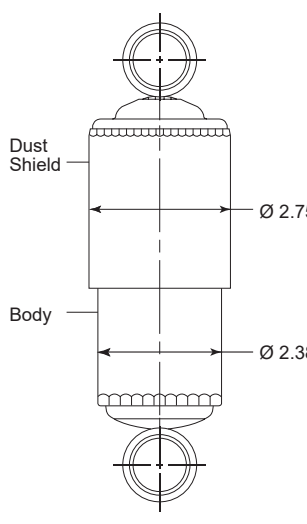

Shock Absorber Diagrams

M83 Series 000/100/200	M83 Series 300	M83 Series 400	M85 Series 000
<p>1 3/8" Bore</p>  <p>Dust Shield</p> <p>Body</p> <p>Ø 2.55</p> <p>Ø 2.38</p> <p>Ø 2.00</p>	<p>1 3/8" Bore</p>  <p>Dust Shield</p> <p>Body</p> <p>Ø 2.55</p> <p>Ø 2.49</p> <p>Ø 2.75</p> <p>Ø 2.38</p> <p>Ø 2.00</p>	<p>1 3/16" Bore</p>  <p>Dust Shield</p> <p>Body</p> <p>Ø 2.06</p> <p>Ø 2.00</p> <p>Ø 1.63</p>	<p>1 5/8" Bore</p>  <p>Dust Shield</p> <p>Body</p> <p>Ø 2.56</p> <p>Ø 2.50</p> <p>Ø 2.19</p>
M85 Series 300/700	M85 Series 900	M87 Series 000	M89 Series 400
<p>1 5/8" Bore</p>  <p>Dust Shield</p> <p>Body</p> <p>Ø 3.25</p> <p>Ø 2.75</p>	<p>1 5/8" Bore</p>  <p>Dust Shield</p> <p>Body</p> <p>Ø 2.75</p> <p>Ø 2.38</p>	<p>2 1/16" Bore</p>  <p>Dust Shield</p> <p>Body</p> <p>Ø 3.25</p> <p>Ø 2.75</p>	<p>1 5/8" Bore</p>  <p>Dust Shield</p> <p>Body</p> <p>Ø 2.75</p> <p>Ø 2.38</p>





CROSS REFERENCE

POWERDOWN TO MERITOR 1-4



Powerdown Cross Reference

Powerdown Number	Meritor Number
------------------	----------------

3

35217	M83225
35221	M83221

4

41024	M85024 M89416
45039	4199
45057	2562 (Truck) 4028 (Bus)
45078	2555 (55mm body) 4249 (70mm body)
45117	2557
45118	4199
45119	40274

7

76015	M85062 M89408
76019	76019
76021	7188
76022	76022
76036	76036
76039	76039
76041	76041
76104	76104
76108	76108
76109	76109
77001	4065
77003	77003

8

83002	M83002
83006	M83006
83009	M83009
83020	M83020
83021	M83021
83024	M83024
83025	M83025
83028	M83028
83029	M83029
83034	M83034
83038	M83038
83049	M83049
895261	9021
895145#	1758

A

AC709	2215
-------	------

B

B47467	1954
B47479	1296

Powerdown Cross Reference

Powerdown Number	Meritor Number
------------------	----------------

B

B47496	1912
B47585	M83033
B47614	8926
B47633	7128
B47710	1826

C

C155	M85001
C156	M85001 M89410
C157	M89410
CC101	M85009
CC102A	M85055
CC102A (for HD apps)	M83312 M89409
CC102AM1	2745
CC104	M85001 M89410
CC105A	M83144 M85919
CC105A (HD)	M89406 M89440
CC105AM2	2721
CC105AM3	2492
CC106 (HD)	M83314
CC107	M85013 M89414
CC108	M85316 M89426
CC108 (HD)	M89426
CC109	M85005 M89430
CC109M2	7207
CC111M1	7243
CC155M1	40149
CD1770	1770
CD504	M83044

G

G56105	56105
G56157	56157

L

L12052	2479
L12106	M83028
L12657	2508
LTS017	69992
LTS528	M85012 M89413
LTS530	M63448

Part number marked in **Bold Italic** represent the Premium, adjustable, heavy duty gas shock absorbers.



**Powerdown Cross Reference**

Powerdown Number	Meritor Number
------------------	----------------

L

LTS759	M63178
LTS760	M63299
LTS762	M63173
LTS763	M83318
LTS782	M63211 M63320 M83114

N

NZ42300	M85300 M89419
---------	-------------------------

P

P076	40275
P079M1	40003
P079M3	M85956
P099	M85906
P101	M85724 M89443
P101M2	M85923
P102	M85030 M89440
P106	40131
P107M4	40085
P107M5	40110
P107M6	40122
P108	4362
P126	M85323 M89436
P132	M85321 M85909
P150	40006
P161	M85738
P162	M85939
P171	M85003
P178	M85938 M89411
P183	40024
P184	21224778
P189	2562 2571
P194	40013 (4x2) 40019 (6x2, 6x4, 8x4)
P198	M85053 M89442
P198M3	2525
P217	2527 40120

Powerdown Cross Reference

Powerdown Number	Meritor Number
------------------	----------------

P

P226	M85918 M89449
P227	4272 50010
P245	2555
P245M1	7175
P251	40151 50011
P251M2	40138
P251M3	40154
P251M7	2593 40016
P270	M85924 M89457
P287	4344 40121
P290	4343
P319	M85319 M89428
P342	50106 21224745
P342M1	50010
P345M2	21225104
P351	M85072
P387	4047 (Euro Truck) M85305 M89425
P388	M85308 M89422
P398	M85938
P42001	M83101
P42013	M85013 M89414
P42013M1	2563
P42013M4	M83121
P42053	M85004
P422	40151
P42300	M85300 M89419
P42372	M83209 M85337 M89414
P42372M4	M83147
P42550	40006
P42550M1	4020
P43313	M83209 M89414

Part number marked in **Bold Italic** represent the Premium, adjustable, heavy duty gas shock absorbers.





Powerdown Cross Reference

Powerdown Number	Meritor Number
------------------	----------------

P

P43313M1	4421
P43313M2	40127
P483	40111
P493	40106
P502	2084 2566
P502M1	2084
P52449	4415
P53024	40024
P53024M1	50108
P53024M2	50040 50126
P653	2557
P657	2558
P657M1	40133
P657M2	4405 2573
P657M5	M85033 M89427
P659	M85080
P660	M85900
P689	40110
P690M1	2775
P699	4199 (Euro Truck) M85901 (US Truck)
P705	M85310 M89423
P705M1	M85902
P738	M89437
P771	M85338
P796	2004 2015
P798	40021
P809	40009
P992	2602 2773 4416

R

RT0012	M83023
RT009	4428
RT02	1826
RT02M1	1094 1770
RT033	2444
RT034	76034
RT043	76043
RT06	M83027

Powerdown Cross Reference

Powerdown Number	Meritor Number
------------------	----------------

R

RT06M1	M83027
RT101	M83122 M85030 M89406 M89440
RT101M1	2219
RT101M3	M83101
RT102	M83204 M85060
RT103BM1	4308
RT104	M83124 M83207 M89407
RT106	M85315
RT107B	76041
RT108	M83112
RT109	2508
RT116	76103
RT116M1	2737
RT121	M85311
RT1770	1770
RT2111	M83019
RT219	M85304
RT336	M63320
RT336 (HD)	M63211 M63320
RT35215	M83215
RT35300	M83456
RT35300.M	M89447
RT35309	M83309 M89446
RT35312	M83312 M89409
RT35318	M83318
RT36215	M83215
RT376	M83003
RT391	M83044
RT41000	M83128 M85000 M89436
RT41001	M85031
RT41006	M85006
RT41006 (HD)	M85006
RT41006M1	7300
RT41006M2	2004
RT41007	M85007 M89412

Part number marked in **Bold Italic** represent the Premium, adjustable, heavy duty gas shock absorbers.





Powerdown Cross Reference

Powerdown Number	Meritor Number
------------------	----------------

R

RT41010	M89405
RT41311	M85311 M85711 M89424
RT41311M1	M85009
RT41316	M85316 M89426
RT52003	M85320 M89429
RT52004	M85305 M89425
RT52004 (HD)	M85305 M89425
RT727	M83314

T

T104	M83318
T107	7051
T110M3	M63320
T233	M63173
T381	M85012 M89413
T381M2	42864
T63178	M63178
T63211	M63211 M63320
T63299	M63299
T63322	M63322
T63419	M83401
T63448	M63448
T63450	M63450

X

XP132	2721 2722
XT42006	M83104
XT45079	M83215

Z

Z77004	4344
ZB47358	M83022
ZCC104	2723
ZP076	2753
ZP079 (HD)	M85013 M89414
ZP079 (XHD)	M85013 M89414
ZP227	40059
ZP992	2774

Powerdown Cross Reference

Powerdown Number	Meritor Number
------------------	----------------

Z

ZZCC104	M85046 M89434
---------	-------------------------

Part number marked in **Bold Italic** represent the Premium, adjustable, heavy duty gas shock absorbers.



CROSS REFERENCE

ASIA	1	KREUGER	10
ATKINSON	1	LEYLAND/DAF	10
AUSTRAL DENNING	1	MACK	10-11
BEDFORD	1	MAN	11-12
BPW	1	MAZDA	12
CSEPEL	1	MERCEDES	12-14
DAF	1	MITSUBISHI	14
DAIHATSU	1	NEWAY	14
DENNIS	1	NEWAY HOLLAND	14
ERF NZ	1-2	NISSAN	14
EVOTRAC	2	PETERBUILT	15
FORD	2	RENAULT/RENAULT NZ	15
FORD NZ	2	REYCO	15
FRANKLIN	2	R.F.S	15
FREIGHTER	2	R.O.R	15
FREIGHTLINER	2-3	RIDEWELL	15
FRUEHAUF	3-4	ROCKWELL	15
GMC	4	SAF	15
HALE NZ	4	SAF HOLLAND	15-16
HAULMARK	4	SCANIA	16-17
HENDRICKSON	4-5	STERLING	17
HINO	5-6	TMC	17
HINO NZ	6	TOYOTA	17
HOLLAND	7	UD	17-18
HUTCHENS (HUTCH NZ)	6-7	VOLVO	18-20
INTERNATIONAL	7	WATSON & CHALIN	20
ISUZU	7-9	WESTERN STAR	20
IVECO	9	WEWELER	20
KASSBOHRER	9	WHITE	20
KENWORTH	9-10	YORK	20



OE Cross Reference

OE Number	Meritor Number
-----------	----------------

ASIA

AA85034700	M63211
G01342100	M89425
MD91282100A	M85304

ATKINSON

3252648R91	M83215
453576C92	M85308
453576C92	M89422

AUSTRAL DENNING

32A02145	7188
32A02317	7188
8.231.220.000	45078
8.231.269.000	45078

BEDFORD

2717604	M83318
2717605	76103
7136681	M85012 M89413
7142012	56157
8814772	M85012 M89413
8821428	M85012 M89413
62-0900	56105
62-8910	56157
65-0271	M85012 M89413
67-0211	M83318
67-0600	76103

BPW

237029200	50103
02.3702.10.00	40006
02.3702.14.00	40024
02.3702.17.00	40006
02.3702.18.00	40006
02.3702.18.00 HD	40006
02.3702.19.00	40024
02.3702.36.00	40024
02.3702.52.00	40024
02.3702.60.00	40006
02.3702.67.00	40006
02.3722.14.00	40024
02.3722.83.00	40024
40-863-0	40006
40-897-0	40024
40-898-0	40006
50-191-2	40024
50-191-6	40024

OE Cross Reference

OE Number	Meritor Number
-----------	----------------

BPW

50-280-7	40006
50-897-0	40024

CSEPEL

VG62-010905	40106
-------------	-------

DAF

70701	M85900
652722	4191
655776	2555
657274	2536
665903	M85900
665906	M85902
665944	M85900
665945	M85902
1205672	4308
1283723	4308
1283732	40021
1283735	2555
1283852	4308
1336828	50103
1375974	4308
1401069	2555
1427903	40121
1443695	40085
1606742	40085
90-2477SP1	M85900
ACHF113	4344
ACHF115	4344
AMPC157	2555
K374-41	M85900
LAK7099	4344
LAK7101	2555
WAK3806	4344

DAIHATSU

48510-87301	M63178
48530-87302	56105
48530-87307-D	M63178
48530-87310	M63178
48530-87312	M63299
48530-87315	M63299
48530-87319	M63178

DENNIS

65-6274	76041
---------	-------

ERF NZ

57241-003	M83112
A-2218	M85030 M89440
NM2999	M83207

Part number marked in **Bold Italic** represent the Premium, adjustable, heavy duty gas shock absorbers.





OE Cross Reference

OE Number Meritor Number

ERF NZ

NM2999	M89407
SL552/31	2562

EVOTRAC (YORK TECAIR FB)

61.610053	M85004
85004	M85004
728616	M85004

FORD (ALSO REFER STERLING)

66193	M83034
680029	M85301
1201-0012	M83023
1202-0012	M83023
18-45067-000	M83034
52270-1030	1954
52270-1031	1954
83DB-5K407-A1C	M83033
B3Q-18125-A	M83217
B3TZ-18125-A	M83217
B7TZ-18124-E	M83217
B7TZ-18125-C	M83217
C1TZ-18124-A	M83217
C1TZ-18125-B	M83217
C1VT-18080-B	M83217
C6TA-18045-U	M85301
D2HA-18045-EB	M85301
E5HT-18045-AA	M85301
E5HT-5K407-AA	M83033
F2HT-5K407-AA	M83033
F2HZ-18124-B	M85301
F6HT-18045-JC	M83200
F6HT-18045-KA	M83200
F6HZ-18124-J	M83200
F6HZ-18124-KA	M83200
F6HZ-5K407-AB	M83034
F6HZ-5K407-BA	M83034

FORD (NZ REFER HINO)

90045132	M85909
16-13957-000	M85724 M89443
16-13957-003	M85724 M89443
16-15817-000	M85724 M89443
47902-008	M83122 M89406
47902-013	M83122 M89406

OE Cross Reference

OE Number Meritor Number

FORD (NZ REFER HINO)

47902-023	M85030 M89440
47902-024	M85013
57241-003	M83112
57241-3	M83112
57905-001	M85013
70DB-18080-BA	76034
79HA-18045-AA	M83309
79HA-18045-AA	M89446
79HA-18045-BA	M83314
79HA-18045-CA	M83312
79HA-18045-CA	M89409
79HA-18045-DA	M83309
79HA-18045-DA	M89446
8126-4376-4MB	76034
81MC-2090-3LB	76034
83DB-18045-SA	76034
EAB1035	76034
EAB796	76034
F1HT-18045-CA	M83312 M89409
F1HT-18045-HB	M85024
F6HT-18045-CC	M85055 M89439
F6HT-18045-EC	M85055 M89439
F6HZ-18124-C	M85055 M89439
S-20886	M85909
W023-28-700	M63299
W023-34-70	M63211
W023-34-700	M63211
W023-99-281	M63299
W023-99-341	M63211

FRANKLIN

6891	M83215
727615	M83215
180-1589	M83215
180-427	M83318

FREIGHTER

728618	M85006
--------	--------

FREIGHTLINER

70042	M85302 M89420
535228	M85302 M89420

Part number marked in **Bold Italic** represent the Premium, adjustable, heavy duty gas shock absorbers.www.meritorpartsonline.com



OE Cross Reference

OE Number Meritor Number

FREIGHTLINER

650361	M83009
654819	M83001
654990	M83006
680009	M85302
680017	M85302
680782	M85302
3501001	M85030 M89440
90045132	M85909
90045504	M85030 M89440
10-12032-000	M85320 M89429
10-12032-001	M85320 M89429
10-12032-002	M85320 M89429
10-12032-003	M85320 M89429
10-12032-004	M85320 M89429
10-12542-000	M85901
10-12703-000	M85918 M89449
10-13021-000	M85918 M89449
10-13063-000	M85918 M89449
10-13211-000	M85918 M89449
10-13634-000	M85918 M89449
1201-0054	M83021
1201-1043	M83025
1201-1044	M83025
1202-0032	M83016
1202-0054	M83021
16-13947-000	M85319 M89428
16-13957-000	M85724 M89443
16-13957-003	M85724 M89443
16-15450-000	M85956
16-15770-000	M85956
16-15817-000	M89443
18-29846-000	M83009

OE Cross Reference

OE Number Meritor Number

FREIGHTLINER

18-30378	M83006
18-30378-000	M83006
18-31476-000	M83020
18-32999-000	M83006
18-32999-001	M83006
18-37813-000	M83044
18-41762-000	M83038
18-41762-002	M83038
18-44321-000	M83009
18-45067-000	M83034
18-60295-000	M83006
18-60764-000	M83038
2508326C1	M83021
60657-003	M85072
680 323 02 00	M85020 M89416
680 323 03 00	M85020 M89416
681 323 09 00	M85009
681 323 13 00	M85009
681 326 02 00	M85011
681 326 04 00	M85319 M89428
681-323-1100	M85301
681-891-0205	M83009

FRUEHAUF

680162	M85300 M89419
5352858	M85305
A-20126	M85323 M89436
A-20889	M85323 M89436
B-23566	M85323 M89436
B-24088	M85323 M89436
MD15236	M85323 M89436
S-20889	M85323 M89436
UCA-01113	M85304
UCA-5431	M85305
UCD-6216-1	M83128
UCE-1295-901	M85300 M89419

Part number marked in **Bold Italic** represent the Premium, adjustable, heavy duty gas shock absorbers.



OE Cross Reference

OE Number	Meritor Number
-----------	----------------

FRUEHAUF

UCE-9399-1	M85030 M89406
UCF-008339-01	M85321
UCF-008339-02	M85321
UJ-B0177-001	M85300 M89419
X2690	M85300 M89419

GMC

3182842	M85711
3192416	M85711

HALE NZ

88-1490	M83207 M89407
---------	-------------------------

HAULMARK

85305	M85305 M89425
85308	M85308 M89422
728607	M85308 M89422
728609	M85305 M89425

HENDRICKSON

659024	M85052
665759	M85052
60670-6	M83121
47902-003	M83122 M89406
47902-008	M83122 M89406
47902-009	M83123
47902-011	M83207 M89407
47902-011L	M83207 M89407
47902-013	M83122 M89406
47902-019	M83123
47902-023	M85030 M89440
47902-024	M85013 M89414
47902-025	M83125
47902-11	M83207 M89407

OE Cross Reference

OE Number	Meritor Number
-----------	----------------

HENDRICKSON

47902-13	M83122 M89406
47902-15	M85013
47902-19	M83123
47902-24	M85013
47902-3	M83122 M89406
47902-8	M83122 M89406
57241-003	M83112
57241-004	M83112
57241-3	M83112
57241-4	M83112
57905-001	M85013
57905-001L	M85013
58715-001	M83121
58715-1	M83121
59483-000	M85919
60657-003	M85072
60657-003L	M85072
60665-005	M85919
60665-008	M83121
60665-011	M85967
60665-8	M83121
60670-005	M83137 M85013 M89414
60670-005L	M85013 M89414
60670-006	M83147
60670-007	M83144
60670-007L	M83144
60670-5	M85013 M89414
60675-002	M83209 M89414
60675-002L	M83209 M89414
60675-003	M83209 M89414
60675-003L	M83209 M89414
60675-006	M83144
60675-006L	M83144
90-2319	M85738
90-2396SP1	M85738

Part number marked in **Bold Italic** represent the Premium, adjustable, heavy duty gas shock absorbers.

www.meritorpartsonline.com

**OE Cross Reference**

OE Number Meritor Number

HENDRICKSON

91-2640	M85938
91-2641SP1	M85738
98583-004	M85738
98583-010	M85938
98583-011	M85738
98583-011R2	M85738
98583-032	M85072
A-14496	M646155
A-1667	M85000 M89436
A-20002	M85000 M89436
A-20416	M83204
A-20886	M83144
A-21292	M85052
A-2160	M85014
A-2212	M85029
A-2218	M85030 M89440
B-21553	M85738
B-21699	M85738
B-21947	M85052
B-21994	M85938
B-21995	M85939
B-23316	M89437
B-23361	M85738
B-23743	M85938
B-23744	M85939
B-24023	M85738
B-24125	M85738
B-24579	M85939
B-25436	M89437
B-25437	M85337
B-25515	M85338
S-23650	M85052

HINO

34802	M83216
47902-024	M85013 M89414
48500-1090	M63320
48500-1111	M85304
48500-1120	M85308 M89422
48500-1140	M85308 M89422
48500-1160	M63211

OE Cross Reference

OE Number Meritor Number

HINO

48500-1170	M85305 M89425
48500-1290	M63320
48500-1291	M63320
48500-1292	M63320
48500-1340	M85308 M89422
48500-1390	M63450
48500-1450	M85305 M89425
48500-1451	2508
48500-1510	M63211
48500-1520	M63211
48500-1521	M63211
48500-1610	M85308 M89422
48500-1630	M63320
48500-1690	M85305 M89425
48500-1700	M85308 M89422
48500-1730	M85308 M89422
48500-1801	M83216
48500-1860	2557
48500-1870	M85304
48500-1880	76043
48500-1940	M83141
48500-1941	M83141
48500-1960	M85311 M89424
48500-2001	M85304
48500-2020	M85304
48500-2061	M63211
48500-2070	2557
48500-2080	76043
48500-2100	2557
48500-2150	M63448
48500-2240	M85308 M89422
48500-2280	M85308 M89422
48500-2292	M85308 M89422
48500-2430	M63448
48500-2760	M63211
48500-3070	M63320

Part number marked in **Bold Italic** represent the Premium, adjustable, heavy duty gas shock absorbers.



OE Cross Reference

OE Number Meritor Number

HINO

48500-3071	M63320
48500-3831	M83104
48530-1120	M83104
48530-1190	M85308 M89422
48530-1250	M85305 M89425
48530-1290	M83215
48530-1451	2555
48530-1460	M85305 M89425
48530-1531	M85308 M89422
48530-1600	M63173
48530-1650	M63173
48530-1691	4428
48530-1711	76041
48530-1721	M85305 M89425
48530-1770	M83215
48530-1800	M85308 M89422
48530-1812	M85308 M89422
48530-1900	M83104
48530-1910	M83216
48530-2000	M85308 M89422
48530-2050	M83217
48530-2120	40106
48530-2121	76041
48530-2510	M83216
48530-3000	M85013
48531-37010	M85012 M89413
48531-37080	M85012 M89413
48531-37090	M63450
48531-37270	M85012 M89413
48531-80671	M85012 M89413
48531-80673	M85012 M89413
48531-80676	M85012 M89413

OE Cross Reference

OE Number Meritor Number

HINO

48531-80685	M85012 M89413
57241-003	M83112
57241-3	M83112
57905-001	M85013
6-031-7708-00	M85308 M89422
6-031-7708-01	M85308 M89422
6-031-7708-02	M85308 M89422
6-031-7708-03	M85308 M89422
60665-005	M85919
60665-5	M85919
60670-005	M85013 M89414
60670-005L	M85013 M89414
60670-007	M83144
60670-5	M85013
60670-7	M83144
6-071-4800-80	M85308 M89422
6071-4800-81	M85305 M89425
6-071-4800-81	M85308 M89422
6-071-4802-63	M63211
60998-001	M85006
6-301-4800-10	M63320

HINO NZ (ALSO REFER FORD)

52270-1030	1954
52270-1031	1954
52270-1110	1954

HOLLAND (ALSO REFER R.O.R)

2501192	4272
212.15.742	50010
212.15.807	50010
212.21.306	50010

HUTCHENS (HUTCH NZ)

1138-0	M85300 M89419
1139-0	M85300 M89419

Part number marked in **Bold Italic** represent the Premium, adjustable, heavy duty gas shock absorbers.



OE Cross Reference

OE Number	Meritor Number
-----------	----------------

HUTCHENS (HUTCH NZ)

9423-00	M83203 M89436
---------	-------------------------

INTERNATIONAL

727615	M83215
3501001	M85030 M89440
90045132	M85909
90045504	M85030 M89440
503421619	M85924 M89457
1660846C91	M83101
1664788C2	M85316 M89426
2015556C1	M85316 M89426
2032533C1	M85316 M89426
204994R91	M83225
3017405R91	M83215
3018492R91	M83312 M89409
3252648R91	M83215
3261051R1	M83023
3261400R91	M83101
3269282R1	M85316 M89426
3270806R1	M85924 M89457
3514952C1	M85013 M89414
3549099C2	M85923
3581106C2	M85924 M89457
3581107C2	M85924 M89457
3581109C3	M85924 M89457
3584535C1	M85924 M89457
3584535C2	M85924 M89457
3584535C3	M85924 M89457
453576C92	M85308 M89422
472367C91	M83318

OE Cross Reference

OE Number	Meritor Number
-----------	----------------

INTERNATIONAL

47902-011	M83207 M89407
47902-024	M85013 M89414
56101-Z5001	M83318
56101-Z5008	M63320
56101-Z5014	M63322
57241-003	M83112
57905-001	M85013
60657-003	M85072
60657-3	M85072
60670-002	M83207 M89407
60670-005	M85013 M89414
60670-005L	M85013 M89414
60670-007	M83144
60670-007L	M83144
60675-003L	M83209 M89414
60675-006	M83144
60675-006L	M83144
855466R91	M63173
88-1641SP1	M85924 M89457
90-2841	M85924 M89457

INTERNATIONAL (METROTEC)

3264773R1	M89414
3267863R1	M83209 M89414
A-4084	M85030 M89406
1202-0032	M83016
3544768C1	M85926
3549100C1	M85926
4C4Z-18125-DA	M85926
596329C1	M85014

ISUZU

1-51630011-0	M85308 M89422
1-51630020-0	76043
1-51630033-0	M63320
1-51630033-1	M63320
1-51630039-0	M63320
1-51630039-2	M63320

Part number marked in **Bold Italic** represent the Premium, adjustable, heavy duty gas shock absorbers.





OE Cross Reference

OE Number Meritor Number

ISUZU

1-51630053-0	76103
1-51630053-1	76103
1-51630053-2	76103
1-51630076-0	M85304
1-51630079-0	M85304
1-51630093-0	M63322
1-51630094-0	M83318
1-51630104-1	1826
1-51630105-2	1826
1-51630105-3	1826
1-51630111-3	76103
1-51630121-1	M63320
1-51630131-0	M85304
1-51630148-0	76041
1-51630151-1	1826
1-51630152-1	1826
1-51630168-1	M63211
1-51630171-0	76103
1-51630171-1	76103
1-51630173-1	76043
1-51630217-0	M63320
1-51630217-1	M63211
1-51630218-0	M63320
1-51630219-0	M63320
1-51630219-1	M63211
1-51630225-1	76103
1-51630225-2	76103
1-51630259-0	M63322
1-51630275-2	M85304
1-51630288-1	76103
1-51630290-1	M63320
1-51630304-0	76103
1-51630372-0	M63448
1-51630381-0	M63211
1-51630391-0	M63320
1-51630429-0	M85304
1-51630433-1	76103
1-51630457-0	76103
1-51630493-0	M83112
1-51630641-0	76103
1-51630712-0	M63211
1-51630746-0	M85013 M89414
1-51630785-0	M83147
1-51630805-1	M85304
47902-024	M85013 M89414

OE Cross Reference

OE Number Meritor Number

ISUZU

5-51630018-2	M63173
5-51630019-1	M63173
5-51630046-1	M63173
5-51630047-1	M63173
5-51630048-1	M63299
5-51630062-0	M85012 M89413
57905-001	M85013
60670-005	M85013 M89414
60675-5	M83147
8-94167458-0	M63211
8-94167458-1	M63211
8-94167460-1	M63299
8-94223293-1	M63173
8-94223752-0	69992
8-94249333-1	M63211
8-94249402-1	M63299
8-94426944-0	M63173
8-97033591-1	M63448
8-97083027-0	M63448
8-97083028-0	M63448
8-97107985-0	M63211
8-97148908-0	M63320
8-97160094-0	M85012 M89413
8-97201960-0	M63448
8-97253605-0	M63320
8-97253613-0	M63211
8-97253614-0	M63320
8-97253643-0	M63450
8-97253651-0	M85012 M89413
8-97253656-0	M63299
8-98079868-0	M85012 M89413
9-51630286-0	M85304
9-51630300-0	M89413
9-51630338-0	M83318
9-51630370-0	2555
9-51630374-0	M85304
9-51630387-0	76034
9-51630388-0	2555
9-51630647-0	M63448
9-51630647-1	M63448
9-51630659-0	69992
9-51630659-3	69992

Part number marked in **Bold Italic** represent the Premium, adjustable, heavy duty gas shock absorbers.www.meritorpartsonline.com



OE Cross Reference

OE Number Meritor Number

ISUZU

9-51630660-0	M63178
9-51630661-0	M63178
9-51630665-2	M63211
9-51630665-3	M63211
9-51630666-0	M85012 M89413
9-51630674-1	69992
9-51630674-2	69992

IVECO

3501001	M85030 M89440
4859825	4405
41033038	2566
41033039	40110
41214460	2566
41214461	40110
41214700	40110
41214818	2566
41214887	2566
41218445	2566
41296211	40110
90044012	2492
90045132	M85909
90045504	M85030 M89440
97134287	40110
97136615	40131
98408700	7207
98408701	2745
98408702	7207
98408707	4405
98411158	7207
98411159	2745
98411160	7207
98411167	4405
98414529	2566
98415096	4405
98416656	2555
98436446	4405
98436447	4405
98447155	4405
98465078	4405
98480455	2571
98493596	2571
99431723	4405
99451728	7207
99451729	7207

OE Cross Reference

OE Number Meritor Number

IVECO

99451732	2745
99451745	7207
99465079	4405
99465080	4405
99465084	2573
99465087	4405
99473748	2571
99473750	2571
99473797	4405
99474655	2566
99484511	2555
99485542	4405
99487470	4405
504051670	1826
504052219	7207
504063434	7207
504148143	7207
908273118	1826
47902-011	M83207 M89407
47902-24	M85013
60657-003	M85072
60657-3	M85072
60670-007L	M83144
9-51630675-1	M63178

KASSBOHRER

8.231.116.000	2555
8.231.150.000D	4401
8.231.346.000	2555

KENWORTH

70701	M85900
665828	M85067 M89451
665903	M85900
665906	M85902
665926	M85047 M89435
665944	M85900
665945	M85902
671794	M85067
671794	M89451
680240	M85302
3166657	M85700
1201-1043	M83025
1201-1044	M83025
1202-0032	M83016
1202-0042	M83025

Part number marked in **Bold Italic** represent the Premium, adjustable, heavy duty gas shock absorbers.



OE Cross Reference

OE Number Meritor Number

KENWORTH

1202-0043	M83025
1202-0044	M83025
1202-1043	M83025
1202-1044	M83025
1202-1046	M83049
1202-1064	M83024
1202-1065	M83002
1202-1164	M83024
1202-1264	M83024
1202K064	M83024
57241-003	M83112
57241-3	M83112
60657-005	M85072
60665-011	M85967
90-2209SP1	M85001 M89410
90-2209SP2	M85001 M89410
90-2209SP3	M85001 M89410
90-2477SP1	M85900
98583-032	M85072
B47467	1954
K374-16	M85031
K374-28	M85305 M89425
K374-29	M85310 M89423
K374-32	M85310 M89423
K374-4	M85305 M89425
K374-41	M85900
K374-7	M85310 M89423
K374-9	M85310 M89423
S-20886	M85909

KRUEGER

1-0280-50-902-0	4272
90-2227	4272
91-2400	21224745

LEYLAND/DAF

70042	M85302 M89420
1091373	M85302
3199967	M85302

OE Cross Reference

OE Number Meritor Number

LEYLAND/DAF

4982103	40106
5533699	M85302 M89420
10897033	M85310 M89423
10897034	M85310 M89423
10901032	4344
10901454	4249
10901511	4249
10922248	40106
5057-104	4428
HLK1873	4249
HLK1897	40106
HLK2161	4249

MACK

5554184	M85302 M89420
20570098	M83147
20863239	M85080
21126793	M85030 M89440
21341752	M85072
90044025	M85013 M89414
90045132	M85909
500356647	1826
5000731488	76034
5000790851	76034
5010052920	7175
5010095217	4344
5010130009	4344
5010130401	7175
5010130641	M83207 M89407
5010294413	7175
5010294414	40140
5010294908	40138
5010294909	40138
5010383050	7175
5010383497	2737
5010383498	76108
5010383685	40138
5010383686	40138
5010383693	7175
5010383694	7175
5010488147	76108

Part number marked in **Bold Italic** represent the Premium, adjustable, heavy duty gas shock absorbers.www.meritorpartsonline.com



OE Cross Reference

OE Number Meritor Number

MACK

5010488160	4378
5010600336	76108
4717000002861	M85014
1202-0032	M83016
14QK142P1	M89425
14QK2100	M83221
14QK2100P1	M83221
14QK2100P5	M83221
14QK2107P1	M85001 M89410
14QK2107P2	M85001 M89410
14QK2111P4	M83019
14QK2113P4	M85007 M89412
14QK2113P5	M85001 M89410
14QK2113P6	M89412
14QK2115	M89425
14QK-288P2	M83217
14QK29401M	M83209 M89414
14QK29402M	M83209 M89414
14QK29403M	M85013
14QK29406M	M85909
14QK29408M	M85013
14QK3108M	M85080
14QK3116M	2721
14QK366P1	M89405
14QK366P4	M85013
14QK372M2	M83209 M89414
14QK376	M83003
14QK378M	M85001 M89410
14QK391AM	M83041
14QK391AM2	M83041
14QK392BM	M85005 M89430
14QK393AM	M83123 M89405
14QK39405M	M85308 M89422
14QK39406M	M85030 M89440

OE Cross Reference

OE Number Meritor Number

MACK

14QK39408M	M83209 M89414
14QK414M	M85906
14QK414M2	M85909
14QK-421M	M85014
14QK429M2	M85072
47902-024	M85013 M89414
47902-9	M83123 M89405
5010130534C	M83027
57241-003	M83112
57905-001	M85013
60657-003	M85072
60657-007	M85072
60657-3	M85072
60657-7	M85072
60665-005	M85919
60670-005	M85013 M89414
60670-005L	M83144 M85013
60670-6	M83147
60670-7	M83144
60675-003	M83209 M89414
60675-003L	M83209 M89414
60680-003	M83112
60680-003L	M83112
NS380020	M83207 M89407

MAN

81.41722.6036	8926
81.43701.6142	50128
81.43701.6144	77003
81.43701.6177	4342
81.43701.6178	4343
81.43701.6195	4428
81.43701.6334	4344
81.43701.6338	2723
81.43701.6346	77003
81.43701.6348	77003
81.43701.6364	4343
81.43701.6392	7175
81.43701.6405	4343
81.43701.6406	4342

Part number marked in **Bold Italic** represent the Premium, adjustable, heavy duty gas shock absorbers.

**OE Cross Reference**

OE Number Meritor Number

MAN

81.43701.6409	76041
81.43701.6410	7175
81.43701.6418	4343
81.43701.6419	4342
81.43701.6426	7188
81.43701.6428	2555
81.43701.6452	2723
81.43701.6491	7243
81.43701.6492	4344
81.43701.6503	M83101
81.43701.6528	4428
81.43701.6535	77003
81.43701.6572	76041
81.43701.6573	4344
81.43701.6574	4344
81.43701.6578	4344
81.43701.6594	40133
81.43701.6595	40133
81.43701.6605	4020
81.43701.6607	76041
81.43701.6610	2722
81.43701.6612	4344
81.43701.6616	4344
81.43701.6619	4344
81.43701.6620	40021
81.43701.6622	4344
81.43701.6630	7175
81.43701.6631	7175
81.43701.6633	4344
81.43701.6634	40021
81.43701.6643	76041
81.43701.6658	40136
81.43701.6699	7243
81.43701.6705	76041
81.43701.6706	2728
81.43701.6713	76041
81.43701.6714	2728
81.43701.6716	76041
81.43701.6721	40021
81.43701.6722	40021
81.43701.6729	76041
81.43701.6751	7243
81.43701.6760	2728
81.43701.6767	76041
81.43701.6768	2728
81.43701.6781	7175
81.43701.6782	2723

OE Cross Reference

OE Number Meritor Number

MAN

81.43701.6784	2721
81.43701.6789	7175
81.43701.6790	40164
81.43701.6793	7243
81.43701.6794	7243
81.43701.6798	2721
81.43701.6804	7243
81.43701.6808	7175
81.43701.6819	7175
81.43701.6821	7175
81.43701.6827	40021
81.43701.6866	40131
81.43701.6880	4344
81.43701.8787	76041
81-43701-6609	M85709
9020M-1042	M85709

MAZDA

W023-28-700	M63299
W023-34-710	M63211
W023-99-281	M63299
W023-99-341	M63211

MERCEDES

665174	M85060
000 240 2348	1826
000 323 9700	76039
000 891 0205	8926
000 891 0305	8926
000 891 0405	1770
000 891 0705	1770
000 891 0805	8926
000 891 1005	8926
000 891 1405	1770
000 891 1605	1770
000 891 2005	1770
001 323 6500	76036
001 323 7800	76019
001 323 7900	7188
001 326 3300	76104
001 326 6500	76022
001 326 6600	76104
001 326 7500	76104
002 326 0900	76104
002 326 1100	2215
002 326 2300	2508
002 326 2900	2215
002 326 4000	2508
002 326 5500	M83101

Part number marked in ***Bold Italic*** represent the Premium, adjustable, heavy duty gas shock absorbers.www.meritorpartsonline.com

**OE Cross Reference**

OE Number Meritor Number

MERCEDES

002 326 9200	4362
002 326 9800	76104
003 323 1900	2444
003 323 2000	2444
003 323 3700	76036
003 323 4700	2508
003 323 6600	2444
003 323 8400	76109
003 323 8500	76109
003 323 8800	2444
003 323 8900	2444
003 323 9600	76036
003 326 3400	2508
003 326 7500	2508
003 326 8000	40073
004 323 0700	2444
004 323 4400	2444
004 323 4400	2444
004 323 4500	2444
004 323 4600	2444
004 323 4900	2444
004 323 5500	2444
004 323 6000	7188
004 323 6100	76019
004 323 6200	2444
004 323 6400	2444
004 323 6500	2444
004 323 6600	2444
004 323 6700	2444
004 323 7400	76019
004 323 8500	76022
004 323 8600	76022
004 323 8800	2566
004 323 8900	7128
004 326 0100	76104
004 326 1300	2219
004 326 2800	2508
004 326 6700	2219
004 326 7000	77003
005 320 0031	2555
005 323 0900	7128
005 323 4000	2444
005 323 4100	2444
005 323 9100	2015
005 323 9500	2444
005 323 9600	2444
005 323 9700	2004

OE Cross Reference

OE Number Meritor Number

MERCEDES

005 323 9900	2004
005 326 0900	40154
005 326 1200	4421
005 326 2000	M83101
005 326 5700	40154
005 326 6000	40154
005 326 6400	40154
005 326 6800	4421
006 323 0700	2444
006 323 0800	2444
006 323 0900	2444
006 323 1600	2004
006 323 3300	2775
006 323 3900	2775
006 323 5100	2004
006 323 5400	2444
006 323 6300	2004
006 323 7200	2004
006 323 7800	2444
006 323 7900	2004
16-13947-000	M85319 M89428
301 240 0048	1826
302 323 0200	2508
302 323 0300	2508
304 700 6497	4428
307 323 0200	2508
307 326 0200	2508
307 326 0300	2508
307 326 0400	2508
345 326 7500	76104
352 323 0000	2566
356 320 0031	2555
356 323 0200	40149
356 323 0500	40149
356 326 0700	2555
357 320 0131	2508
357 323 0600	4428
357 326 0000	2508
357 326 0100	2508
357 326 0300	4428
364 326 7200	2508
381 326 0200	40133
384 891 7005	8926
385 326 0100	4065
385 326 0200	4065
391 326 0100	2215

Part number marked in ***Bold Italic*** represent the Premium, adjustable, heavy duty gas shock absorbers.



OE Cross Reference

OE Number Meritor Number

MERCEDES

396 320 0030	2508
617 326 0000	40133
634 323 0100	2508
664 240 70 48	1826
681 326 0400	M85319
688 323 7000	7128
688 326 7000	7128
974 323 0000	7300
974 323 0400	7300
974 323 0600	7300
974 323 1100	7300
974 326 0100	40127

MITSUBISHI

03260-82005	4199
57905-001	M85013
60670-005	M85013 M89414
MA222515	M63178
MB025127	M63320
MB025381	M63320
MB025382	M63320
MB025383	M63320
MB025384	M63320
MB161555	M63299
MB161741	M63178
MC035110	76103
MC035111	M85311 M89424
MC091047	76103
MC091726	M85311
MC091947	M63448 M85311
MC091949	76043
MC092215	M63320
MC093586	M63320
MC096225	M63299
MC114594	M63178
MC114595	M63178
MC189093	M63211
MC189924	M63178
MC352586	M63299
MC357241	M63299
MC357243	M63320
MC628804	M85311
MC629044	76043
MC802624	M63320
MC805986	76034

OE Cross Reference

OE Number Meritor Number

MITSUBISHI

MC806993	M85304
MC808521	4199
MC809389	56105
MC809390	56105
MC811327	M83318
MC813135	M83318
MC813511	56105
MC814614	M63448
MC816002	2557
MC816093	4199
MC816100	M63320
MC816202	M63320
MC819779	M83318
MC819780	M83318
MC826136	M63320
MC826268	M63320
MK432143	M85311
MK469020	M63211

NEWAY

90044089	M83124 M89407
90044162	M85000 M89436
90044625	M83125
90044626	M85030 M89440
90044642	M85060
90044992	M85000 M85323 M89436
90045338	M85060

NEWAY HOLLAND

3501001	M85030 M89440
90044025	M85013 M89414
90044968	M89414
90045099	M85906
90045132	M85909
90045504	M85030 M89440

NISSAN (ALSO REFER UD)

56110-82625	M63320
56110-90167	M85316 M89426
56210-Z6003	M85308 M89422

Part number marked in **Bold Italic** represent the Premium, adjustable, heavy duty gas shock absorbers.



OE Cross Reference

OE Number Meritor Number

PETERBILT

654782	M83008
02 01787	M85062 M89408
02 02737	M85062 M89408
02 02742	M85062 M89408
03 05384	M85033 M89427
03 06084	M85033 M89427
03 07421	M85311 M89424
03 07423	M85033 M89427
04629 03	M85311 M89424
29-02455	M83008

R.F.S (ALSO REFER KREUGER)

90-2227 4272

R.O.R

2.376.001.001	50040
2.376.001.002	50040
2.376.001.400	50040
2.376.001.800	50040
212.08.363	50108
212.15.607	4272
212.15.742	50010
212.15.751	50010
212.15.807	50010
212.16.058	50108
212.21.306	50010
212.21.348	50126
212.22.271	21224745
212.24.034	50108
212.24.531	21224745
212.24.745	21224745
212.24.778	21224778
212.25.104	21225104
90-2017	40006
90-2022	50010
90-2210	21224745
90-2227	4272
90-2316	21224745
90-2368SP2	21224745
90-2456	21225104

OE Cross Reference

OE Number Meritor Number

RENAULT/RENAULT NZ

5000356647	1826
5000788364	4392

REYCO

665833	M85052
12885-01	M85300 M89419
12885-03	M85300 M89419
12887-01	M85024 M89416
17146-01	M85013 M89414
18165-01	M85024 M89416
18286-01	M85009
20126-01	M85030 M89440
20960-01	M83204
23523-01	M89436
23553-01	M85323 M89436
700098-03	M85052
702136-01	M85052
702209-01	M85014
702963-01	M85323

RIDEWELL

665526	M85014
1250563B000	M85323 M89436
1250789B000	M83207 M89407
1270563B000	M85738

ROCKWELL

21223345	21223345
21226989	21226989
21228392	21228392

SAF

2376003100	50103
2.376.001.600	2564
2.376.002.600	40024
2.376.002.700	40059
40 1700 123 247	40024

SAF HOLLAND

90044833	M85052
90044834	M85052
90045534	M85014
AR-1404	M85301

Part number marked in **Bold Italic** represent the Premium, adjustable, heavy duty gas shock absorbers.

**OE Cross Reference**

OE Number	Meritor Number
-----------	----------------

SAF HOLLAND

AR-1425	M85301
AR-995	M85734

SCANIA

216975	40121
216976	2558
216977	2479
258420	2555
272400	2562
279011	2558
279927	40121
307055	2558
307111	2558
328111	2215
337270	1296
348232	1296
349007	1912
366426	2555
367242	1912
390563	2558
395063	2558
395064	2555
403245	4249
410554	40106
419131	2555 4249
421280	4028
424307	4249
429161	40106
429162	4249
468189	4249
468194	4028
468198	4249
470264	40106
470267	4249
470268	4249
475915	40106
483550	4308
483551	40106
483553	40106
485131	40106
488824	40106
520275	1296
524118	1912
1012044	2558
1012045	2558
1110531	2562
1110588	2558

OE Cross Reference

OE Number	Meritor Number
-----------	----------------

SCANIA

1110589	2555
1111056	2558
1303235	2562
1307332	2562
1309129	2562
1314479	2558
1315959	2558
1323476	2562
1327145	2562
1327211	2558
1327813	2562
1331756	2562
1340252	2558
1340253	2555
1340254	2562
1340256	40121
1342787	2558
1342788	2562
1353105	2562
1354966	2558
1356723	2558
1370267	2558
1371417	2558
1375832	40121
1377056	2562
1377057	2562
1377058	2562
1380424	40151
1380425	40151
1381807	2558
1381808	2555
1381809	2562
1381810	2215
1388417	2558
1390898	2084
1397523	40151
1397525	2555
1420474	2558
1421062	2558
1462240	40106
1478317	2555
1478501	2084
1478503	2562
1478506	40151
1480214	4308
1480215	4308
1481359	40106

Part number marked in ***Bold Italic*** represent the Premium, adjustable, heavy duty gas shock absorbers.

**OE Cross Reference**

OE Number	Meritor Number
-----------	----------------

SCANIA

1488337	40106
1519630	40151
1523283	4308
1523289	40106
1920824	40106
415849-9	4249
429163-9	40106
8.231.187.000	2555
8.231.220.000	45078

STERLING

3501001	M85030 M89440
90045132	M85909
90045504	M85030 M89440
10-13684-000	M85918 M89449
16-13957-000	M85724 M89443
16-13957-003	M85724 M89443
16-15770-000	M85956
16-15817-000	M85724 M89443
47902-024	M85013 M89414
4C4Z-18125-DA	M85926
57905-001	M85013
60657-003	M85072
60657-3	M85072
60670-005	M85013 M89414
60670-007	M83144
60670-007L	M83144
60675-006	M83144
60675-006L	M83144
F6HT-18045-CC	M85055 M89439
F6HZ-18124-C	M85055 M89439

TMC

TOYOTA

48511-26090	69992
48511-26190	69992

OE Cross Reference

OE Number	Meritor Number
-----------	----------------

TOYOTA

48511-36070	M63173
48511-36140	M63211
48511-36150	M63211
48511-39065	M63299
48511-39075	M63299
48511-39076	M63299
48511-39225	M63211
48511-39226	M63211
48511-39235	M63178
48511-39305	M63211
48511-39306	M63211
48511-39355	M63211
48511-39495	M63211
48511-39505	M63211
48511-39525	M63211
48511-39535	M63211
48511-80035	M63211
48511-80442	M63173
48531-29276	M63299
48531-30080	M63299
48531-36100	M63178
48531-36110	M63178
48531-36120	M63178
48531-36140	M63178
48531-36160	M85012 M89413
48531-39115	M63173
48531-39455	M63299
48531-39495	M63178
48531-39505	M63178
48531-39515	M63178 M63299
48531-39525	M63178
48531-39715	M63299
48531-69015	M63178
48531-80154	M85012 M89413
48531-80445	M63178
49531-39115	M63173

UD

56101-00Z00	76103
56101-30Z01	M63320
56101-30Z02	76103
56101-30Z10	M63322
56101-Z1030	M85311
56101-Z2000	M85311
56101-Z2001	M85311

Part number marked in **Bold Italic** represent the Premium, adjustable, heavy duty gas shock absorbers.





OE Cross Reference

OE Number Meritor Number

UD

56101-Z2002	M85311
56101-Z2004	76103
56101-Z2005	76103
56101-Z2006	76103
56101-Z2009	76103
56101-Z5000	M63320
56101-Z5001	M83318
56101-Z5008	M83114
56101-Z5009	M63320
56101-Z5014	M63322
56101-Z5016	M63320
56101-Z5017	M63322
56110-00Z00	76103
56110-30Z01	M63320
56110-30Z02	76103
56110-30Z05	M63320
56110-30Z10	M63322
56110-90064	76043
56110-90112	M85311 M89424
56110-90167	M85316 M89426
56110-90172	M85311
56110-90201	M85311
56110-90Z01	M85311
56110-Z2000	M85311
56110-Z2002	M85311
56110-Z5001	M83318
56110-Z5002	M83318
56110-Z5003	M63322
56110-Z5004	M63322
56110-Z5014	M63322
56110-Z5016	M63320
56110-Z5017	M63322
56110-Z6012	M85304
56110-Z6070	76041
56210-00Z07	M83121
56210-00Z11	M85013
56210-90003	M85311
56210-90019	M85305 M89425
56210-Z5002	M83318
56210-Z6003	M85308 M89422
58715-001	M83121
58715-002	M85013
58715-1	M83121

OE Cross Reference

OE Number Meritor Number

UD

60665-001	M85013
60665-008	M83121
95245-30Z05	M83009
98583-005	M85013
98583-005	M89414
98583-006	M85013 M89414
98583-016	M85013

VOLVO

62227	1954
344574	1954
353958	1954
362960	4047
365376	2557
365377	4199
366427	4344
646220	M85734
665739	M85047 M89435
1089008	1770
1091372	M85301
1134748	40274
1134749	40275
1136643	40274
1136644	40275
1137026	40274
1137027	40274
1137028	40275
1137029	40275
1505184	M85901
1505185	M85901
1505892	1954
1508429	1954
1568340	M85901
1580387	1758
1580389	1758
1580390	1770
1585586	1094
1586068	9021
1587562	1770
1588043	1954
1590431	M85901
1590439	4199
1591735	2526 M85901
1591736	M85901
1591737	2524

Part number marked in **Bold Italic** represent the Premium, adjustable, heavy duty gas shock absorbers.



OE Cross Reference

OE Number Meritor Number

VOLVO

1591737	M85901
1598105	40013
1598106	50011
1598814	40121
1599450	1770
1599623	40275
1605163	40019
1608888	M85901
1609001	40016
1609002	40016
1609005	40013
1609428	1954
1609553	40275
1609603	40275
1610920	40275
1610921	40275
1612217	2527
1622085	1770
1622086	1770
1622087	9021
1628189	2773
1628359	2527
1629405	40120
1629476	40120
1629477	40121
1629480	2773
1629481	2593
1629482	40111
1629483	40111
1629484	40111
1629485	4416
1629722	8906
1629920	2593
1629992	2595
1629993	2527
1691617	2773
1696100	2525
3027113	2774
3031623	2753
3031624	40275
3031625	40275
3031626	40275
3031627	40275
3036162	40275
3037213	2774
3039244	M85007 M89412

OE Cross Reference

OE Number Meritor Number

VOLVO

3112260	M85310 M89423
3112261	76041
3171962	2602
3171963	4416
3199975	M85700
3199982	M85703
3199989	M85709
3953642	2769
3953644	2563
3987957	2602
3987958	4416
3987959	2774
3987960	2773
3987961	2593
6775414	2525
6779275	M83101
6790175	M83101
6794746	M83101
6856631	7051
6873143	7051
6874412	2555
6884278	1954
8026658	M85046 M89434
8030367	76041
8071524	M85024 M89416
8078546	M83028
8078547	M83029
8151708	40275
8152712	76041
8153538	40121
8159833	40275
8169859	M85047
9516389	40122
9522179	76041
20374543	40009
20374544	40003
20374546	4416
20374548	2602
20401856	40003
20585555	40003
20585556	40009
20766063	40009
21232663	40009
70313745	76041

Part number marked in **Bold Italic** represent the Premium, adjustable, heavy duty gas shock absorbers.

**OE Cross Reference**

OE Number	Meritor Number
-----------	----------------

VOLVO

1130538-0	2557
1130539-8	4199
3037213P01	2774
35901-0003	M85301
6873143-2	7051

WATSON & CHALIN

10147	M83203 M89436
11418	M646155
17297	M85064 M85938
17300	M85052
17306	M85938
665769	M85052

WESTERN STAR

57252	M85308 M89422
676081	M83401
676082	M83401
725470	M83010
90044025	M85013 M89414
90044968	M89414
90045099	M85906
90045132	M85909
04-9041375	M85315
1202-0032	M83016
12887-01	M85011
16-15770-000	M85956
19824-01	M85024 M89416
37301-3401	M85053 M89442
37301-3403	M85053 M89442
37301-3404	M85053 M89442
37301-3405	M85053 M89442
37301-3409	M85053 M89442
37301-3412	M85053 M89442
37390-4401	M85053 M89442
37390-4402	M85053 M89442

OE Cross Reference

OE Number	Meritor Number
-----------	----------------

WESTERN STAR

37390-4403	M85053 M89442
47902-024	M85013
57241-003	M83112
57241-3	M83112
57905-001	M85013
57905-002	M85013
60657-003	M85072
60657-003L	M85072
60657-005	M85072
60665-011	M85967
60670-005	M85013 M89414
66010-3401	M83022
66010-3402	M83022
66010-3403	M83022
66010-3404	M83022
66010-3406	M83027
98583-032	M85072
CP5222	M85315

WEWELER

90-2022	50010
90-2022SP	50010
90-2227	4272
91-2227	50010
91-2643	50010

WHITE

5534430	M85308 M89422
5554959	M83401
37001-5	M83401
494-660	M85060
570-S-5	M85304

YORK

61.506246	4415
61.610052	M85003 M89411
61.610053	M85004
85003	M85003 M89411
728603	M85003 M89411
61.506717.01	4415

Part number marked in **Bold Italic** represent the Premium, adjustable, heavy duty gas shock absorbers.





Meritor Heavy Vehicle Systems
50 Calarco Drive
Derrimut Vic 3026 Australia

Phone: (+61 3) 8353 6050
Email: cvaa.sales@meritor.com
Website: meritorpartsonline.com.au

©2022 Meritor, Inc.
Australia, CAT010
Issued 02-22